

## Which Technology for the Application

### RST Round Shaft Technology

Linear Bearings and Shafting

- Self-lubricating PTFE linear plain bearings and linear ball bearings
- Round shafting in steel, stainless steel, and ceramic coated aluminum



### GST Gliding Surface Technology

Plain Bearing Linear Guideways

- Low profile modular designs
- Self-lubricating PTFE liners and polymer inserts
- Tolerates washdowns and harsh environments



### IVT Integral-V™ Technology

Linear Guide Systems

- Anodized aluminum with an embedded hardened stainless steel raceway
- Adjustable pre-load
- Ideal for all types of t-slot aluminum framing



### CRT Cam Roller Technology

Roller Bearings and Linear Guideways

- Radial ball bearings of diverse profiles and engineering materials
- High speeds, acceleration, and long travel lengths



### Mechatronics Enabled

The Mechatronics Enabled product line offers a broad range of mechatronic solutions for small, medium, large, and extra-large applications. Choose from belt, ball screw, lead screw or un-driven systems complete with a number of mounting and performance accessories.



For Custom Configurations, Call an Application Engineer at 1-800-962-8979.

**PBC Linear**

[pbclinear.com](http://pbclinear.com)

To Order: 1-800-962-8979

6402 E. Rockton Road  
Roscoe, Illinois 61073 USA

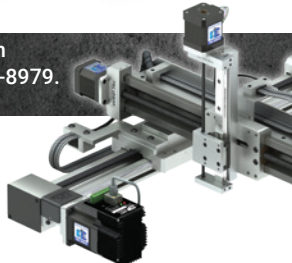

LITACCORDION-001 (r2 10-2018)



## Linear Motion Product Overview

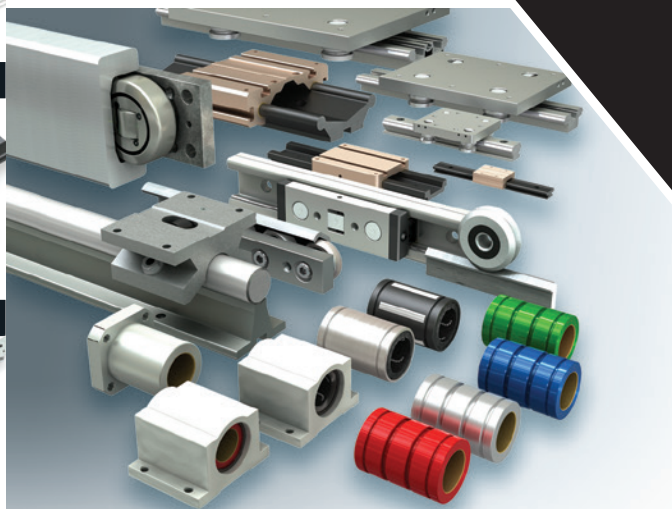

## Linear Motion Components

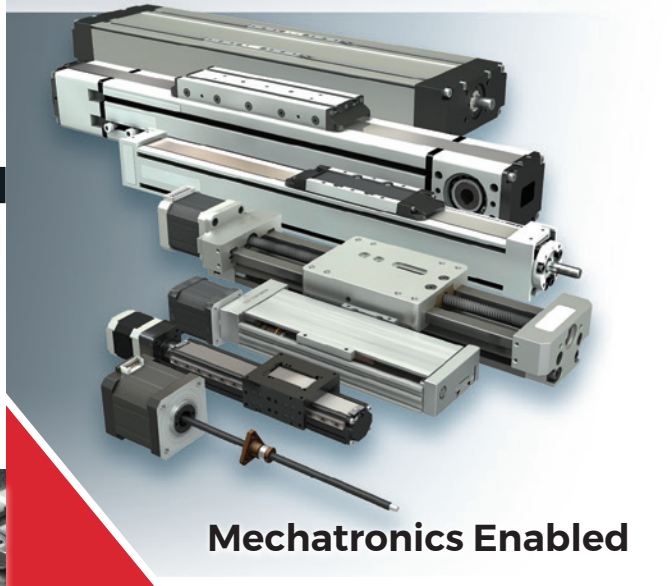

## Mechatronics Enabled



Configure at  
[pbclinear.com](http://pbclinear.com)

# Round Shaft Technology RST

## Simplicity® Plain Bearings

- Self-lubricating, maintenance-free, no external lubricants
- Low wear and friction, patented PTFE liner
- High strength, 20x more load capacity than a ball bearing
- Wide temperatures range (-400°F/+400°F) (-240°C/+204°C)
- Corrosion-resistant, excels in dirty environments
- No rolling elements prevents catastrophic failure

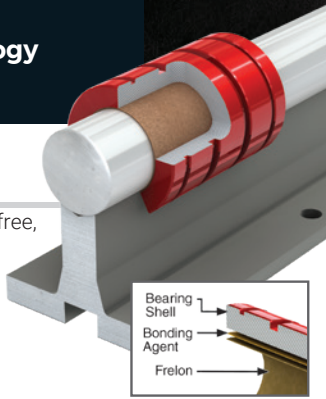

Bearing wipes away debris

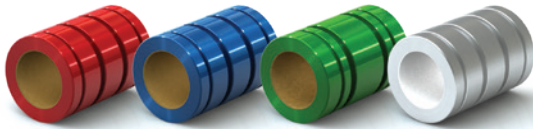
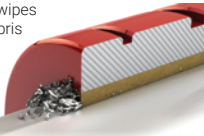

### FrelonGOLD®

is a dark gold colored high performance material with gold-colored fillers for case hardened shafting.

### Frelon® J

is a yellow colored material specially formulated to provide optimum performance for 300 series stainless steel and softer metal shafting.

### Frelon W

is a white colored material formulated to be FDA compliant for 300 series stainless steel and softer metal shafting.

**Note:** Frelon W requires minimum order quantity

## Open



## Pillow Blocks



## Flange, Die Set, Sleeve, and Square



## Ball Bearings

- Polymer cage fits more balls per track than steel cage
- Built-in double seals
- Industry interchangeable
- Delivers quiet operation and higher load capacity

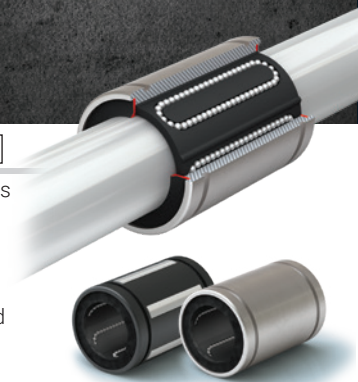

## Roller Pillow Blocks

- High load capacities, up to 12500 lbs
- Speeds up to 25 ft. per second
- Accommodates round shaft diameters of 0.5–3.0 inches
- Well suited for long travel applications
- Not affected by small particulates

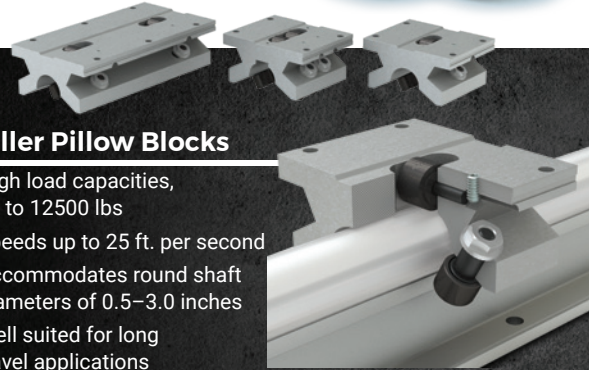

## simplicity 60 PLUS SHAFTING

## Shafts

- Steel shafts are made of polished, case hardened steel and suitable for Simplicity® plain & ball bearings
- Ceramic coated aluminum rails, non-magnetic, lightweight, and chemical resistant
- Aluminum alloy support rails available in one or two-piece design and pre-assembled
- End-joinable for longer travel lengths

**Material:** RC60 steel, 300/400 series stainless steel, Ceramic-coated aluminum

**Special Machining:** Solid, Pre-drilled, Tapped



## Simplicity Linear Slides

- Various NEMA motor mount sizes available
- Four (4) pillow block assemblies
- Two (2) steel shafts
- Two (2) aluminum support rails
- Mounting plate
- Hand crank version available

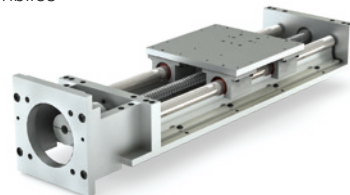

# Gliding Surface Technology GST

Two-piece assemblies equipped with FrelonGOLD® liner create a low friction, maintenance-free, smooth, and quiet linear motion. No metal-to-metal contact eliminating catastrophic failure.

## Uni-Guide™ I

- Optimal strength
- Drive option: lead screw
- T-slots for ease of installation
- Easy drop in unit—no alignment necessary

Material: Ceramic coated aluminum rail, anodized carriage with FrelonGOLD liner

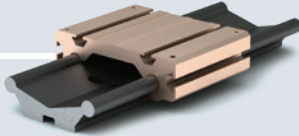

## Low Profile Uni-Guide M

Ideal for contaminated environments and clean rooms, washdown optimized, and hard anodized aluminum prevents contaminants from sticking

- Compact design (24 mm height profile)
- **SIMO®** qualified rail

Material: Ceramic coated aluminum rail, anodized carriage with FrelonGOLD liner

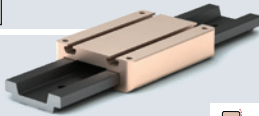

Angled rail surface prevents particulate build-up

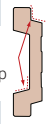

## Mini-Rail® M

Requires little maintenance, is dimensionally interchangeable with industry standard sizes, and is maintained in stock for quick delivery.

- Compact design, small footprint
- Corrosion-resistant—ideal in harsh environments
- Available in five (5) sizes, in lengths up to 3600 mm
- Optional running clearances for misalignments
  - Precision Series (Standard) 0.025–0.051 mm running clearance
  - Compensated Precision Series 0.064–0.089 mm running clearance

Material: Ceramic coated aluminum rail, anodized carriage with FrelonGOLD liner

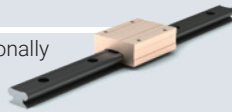

## Low Profile Mini-Rail M

The perfect low cost solution for compact, low friction linear motion applications. The anodized aluminum rails offer a unit that is resistant to contaminants, dyes, and weak acids.

- Molded polymer slider with molded-in stainless steel threaded inserts
- Industry standard interchangeable
- Compact, low friction solution
- Temperature range: -35°C to +65°C
- Available in four (4) sizes

Material: Anodized aluminum rail Polymer slider

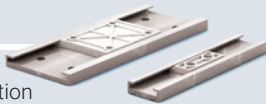

# Integral-V Technology IVT

Integral-V™ runs along a precision machined anodized aluminum rail with high-speed v-wheel cam rollers, eliminating mounting components, and cutting assembly time in half.

IVT is ideal for contaminated environments and high speed/acceleration applications. SIMO® machined for precision qualified rail surfaces, to within .050 mm (.002") Hardened stainless steel races eliminate fasteners and reduce mounting components by 40%

Handles loads up to 10,020 N (2,252 lbs)  
Standard lengths up to 3,650 mm

**NO Bow**



**NO Twist**



**NO Warp**

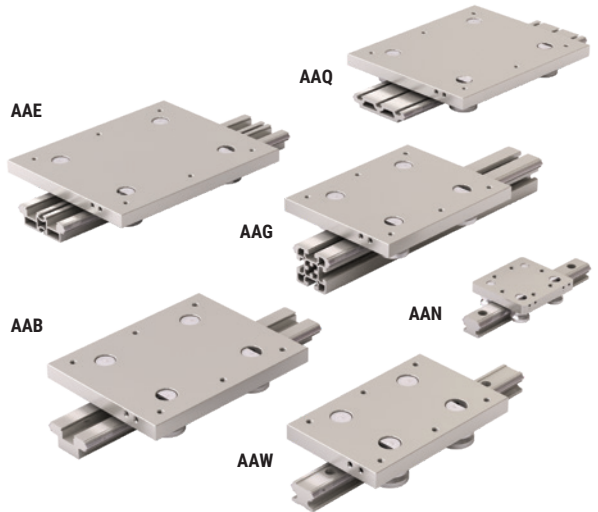

## Fewer Installed Parts Saves Time & Money

Conventional Profile Rail

Integral-V System

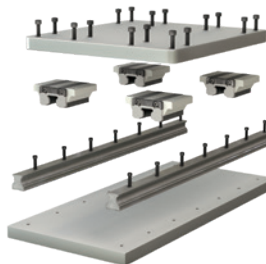

**38 Components**  
120 min. installation

**2 Components**  
30 min. installation



# Cam Roller Technology CRT

## Redi-Rail I M

Precision straight rails and hardened gothic arch rollers are strong and lightweight. Ideal for high speed and moderate load linear motion.

- High load capacities
- Patented side-adjustable preload simplifies assembly and installation
- Corrosion-resistant; excels in dirty environments
- Rail lengths up to 5,800 mm; end-joinable for longer lengths
- Gothic arch rollers with sealed double row bearings
- Rollers 52100 BRG STL HRC 58-62 or 440C STN STL HRC 58-62

Material: Aluminum alloy rail with hardened steel raceways

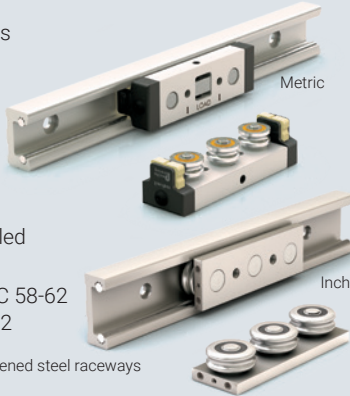
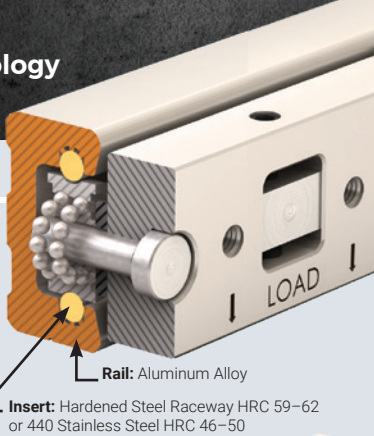

## Low Profile Redi-Rail M

- Lengths up to 3 m (10 ft)
- Compact design, 19 mm height profile
- High load capacities, up to 510 N/110 lbs
- Gothic arch rollers with sealed double row bearings
- Ideal for material transfer in unattended kiosks & applications requiring precise linear motion within a confined area.

Material: Aluminum alloy rail with steel or stainless steel raceways



## Commercial Rail M

- Cost-effective solution for automation or sliding door applications
- Speeds up to 1.5 m/s
- Three (3) rail sizes 20, 30 and 45 mm
- Rails are zinc-plated steel
- Aluminum alloy slider with optional chrome or stainless with rollers of either 52100 steel or 44C stainless
- Rollers lubricated for life & sealed against contamination
- Left or right hand mountable



## Heavy-Rail M

Heavy-duty linear bearing system that is cost effective for medium to low precision applications. High radial and axial load capacities ensure a long and productive life. Idea for telescoping applications.

- Handles loads up to 60 tons
- Fixed or adjustable bearings

### Rail

- Lengths up to 6 m
- U or I channel design
- Sandblasted or lightly oiled

### Flange Plate

- Available pre-welded to bearing

### Adjustable Clamp Flange

- Eliminates welding and straightening

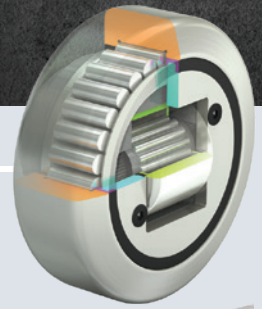

## V-Guide I M

Ideal for high speed requirements, accuracy, and repeatability

### V-Guide Wheels

- Precision ground dual row bearing
- Permanently internally lubricated

### Wheel Bushings

- Mount into V-Guide wheels for fixed or adjustable applications

### V-Rails

- Simple mounting and alignment
- Rails available in (4) sizes
- Induction hardened polished rail

Material: Stainless steel or carbon steel



## Hardened Crown Rollers, Rails and Brackets

- Simple solution for point-to-point applications
- Rolling element bearing with 9/16" hex head
- Rollers, angle brackets, and end stops sold separately
- Rails available up to 10' bare steel or black powder coated



# Lead Screw

PBC Linear Lead Screws are designed to work perfectly with the Constant Force™ Anti-Backlash nut.

Through years of testing and process improvements, PBC Linear is proud to offer the most accurate standard lead accuracy on the market.

- CNC Roll Threading allows for standard accuracies of .003"/ft. (2-3 times better than the competition). Precision lead accuracy of .001"/ft is available upon request.
- Proprietary process has resulted in less pitting and flanking, which results in longer life.
- 300 series stainless steel with PTFE coating
- Screw diameters of 6, 10, 12, and 16 mm and  $\frac{3}{16}$ ,  $\frac{1}{4}$ ,  $\frac{3}{8}$ ,  $\frac{7}{16}$ , and  $\frac{1}{2}$  inch
- Various Leads of 1, 2, 4, 5, 6, 8, 10, 12, 16, 25 mm and 0.05, 0.2, 0.25, 0.333, 0.5, 1.00 inches

## Innovative Anti-Backlash Nuts

- Patented Constant Force Lead Screw line applies uniform pressure to the nut at all stages of the motion profile.
- Superior Performance, 2-4x less backlash over the life of the device, as validated by leading lab automation customer testing
- All nut styles are self-lubricating for the life of the nut
- Custom solutions available

## World Class Motors Optimized for Linear Motion

- NEMA 8, 11, 14, 17, and 23 motor sizes
- 30% more torque available
- Laser welded screw and motor providing more accurate alignment
- Larger bearings provide increased thrust capacity and longer life

- Hollow shaft concentricity ensures minimum screw runout
- Preload on bearings eliminates axial play
- Standard mounting provisions for encoder feedback

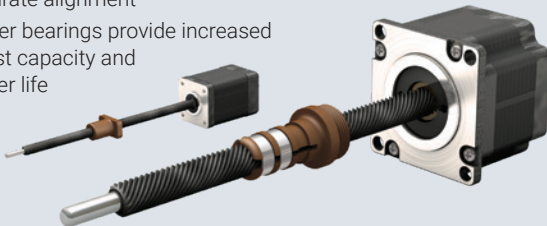
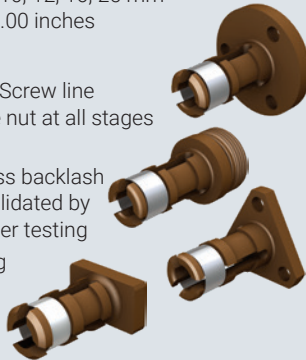
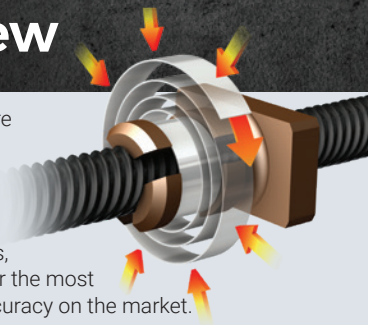

# Compact Series

Smooth. Accurate. Repeatable. Compact Series boasts a low profile of 23 mm providing reliable linear motion in tight spaces.

With 300 series stainless steel lead screw with PTFE coating, this system is able to adjust to many different applications with configurable options.

- Plain bearing or ball bearing
- Lead screw diameter and lead options
- Constant Force Technology nuts or standard fixed nuts
- Motor options: Integrated motor or motor mount setup

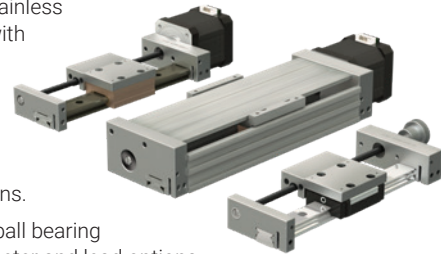

## Gliding Surface Technology Rail

6 mm Dia. Lead Screw  
Maximum rail length of 510 mm

- Smooth and quiet operation
- Shock resistant
- Cover option not available
- Utilizes the bonded FrelonGOLD® self-lubricating and maintenance free bearing surfaces

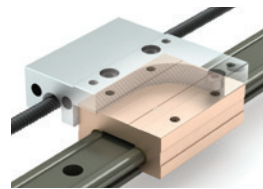

## Profile Rail Technology Rail

8 mm Dia. Ball Screw  
6 mm & 10 mm Dia. Lead Screw  
Maximum rail length of 1000 mm

- High precision, rigidity, and speeds
- Supports cantilevered loads
- Low coefficient of friction
- Increased stiffness and preloaded bearing performance
- Non-covered, low profile covered, or tall profile covered

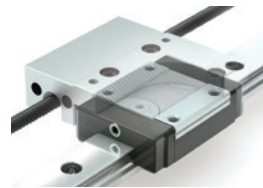

# ML Series

- 10 mm Dia. Lead Screw with multi-dovetail guided polymer nut design
- Compact profile 28 x 32 mm
- Long travel lengths, up to 650 mm
- **SIMO** precision machined surfaces
- Available with single or dual rail blocks for increased load and moment load capacities
- High speed precision and precise repeatability
- Designed to excel in biotech, medical and small-scale automation that requires compact space and precise motion



# SIMO®

PBC Linear has revolutionized traditional machining with the patent pending **SIMO** (Simultaneous Integral Milling Operation) process. The **SIMO** process uses synchronized cutters, eliminating built-in extrusion variances by machining all critical edges concurrently in one pass. This ensures tight tolerances, limited variance and a remarkably straight and repeatable surface at negligible additional cost!

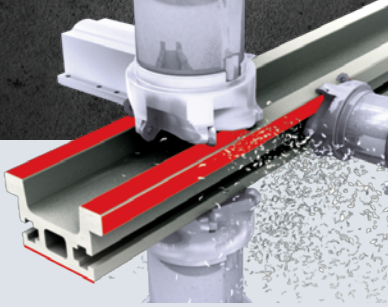

## Belt Drive

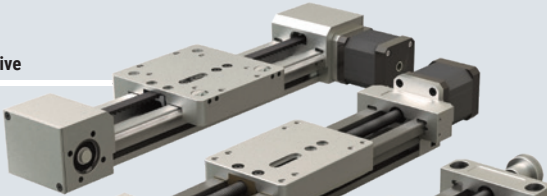

## Lead Screw





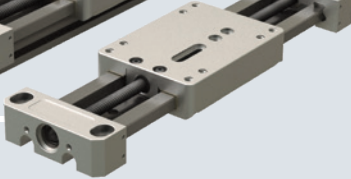



## Low Profile

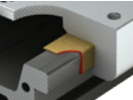

**SIMO** Series Actuators are versatile, flexible, and affordable.

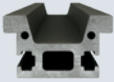
**SIMO** actuators are built on either a low profile or tall base rail with configurable bearing and drive options that can be tailored to exceed performance requirements.

## Configuration Options

Rail Height	Bearing Type	Drive Type	Motor Size
 <p>24 mm with carriage</p>	 <p>Plain Bearing</p>	 <p>Lead Screw</p>	 <p>NEMA 17</p>
 <p>40 mm with carriage</p>	 <p>V-Guide Bearings</p>	 <p>Belt</p>	 <p>NEMA 23</p>

Uniform dimensioning gives the engineer great design flexibility, while the interchangeability offers a wide range of features and benefits, all within one platform.

# MTB

A lightweight and fast system with long travel and a multitude of options.



- Belt Driven
- Long travel lengths
- Fully enclosed aluminum housing
- High acceleration, speeds and rigidity
- Male and female drive shaft configurations
- Strong yet lightweight and corrosion-resistant
- **SIMO** precision machined surfaces

# PLA Series

Ideal for medium load applications where the precision of screw drives are needed.

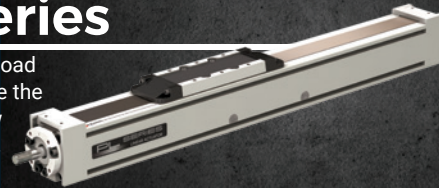

- Ball or Lead Screw Driven
- Sealed against contamination
- **SIMO** precision machined surfaces
- High speed cam roller design creates smooth precision guidance
- Enclosed aluminum housing with Integral-V™ raceway

# MUK Series

The most heavy duty actuator PBC Linear offers, providing precision and rigidity.



- Incorporates two 20 mm recirculating ball profile rail guideways
- Load capabilities up to 11200 N
- Single or dual carriage options available
- Class 7 (52 μm/300 mm) travel accuracy ball screw is standard, consult factory for other options
- Compact aluminum profile incorporates t-slots for easy sensor mounting