



Catalogue

IN THE FIELD OF
"ADHESIVE BONDING TECHNOLOGY"
**SUPPLIER OF
THE YEAR 2021**



www.weicon.com

V 1.22



Management System
ISO 9001:2015
ISO 14001:2015
www.tuv.com
ID 9108636595



WEICON®

Simply find solutions.

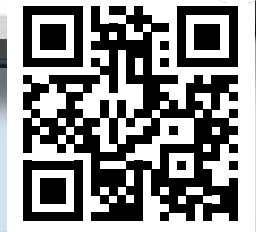
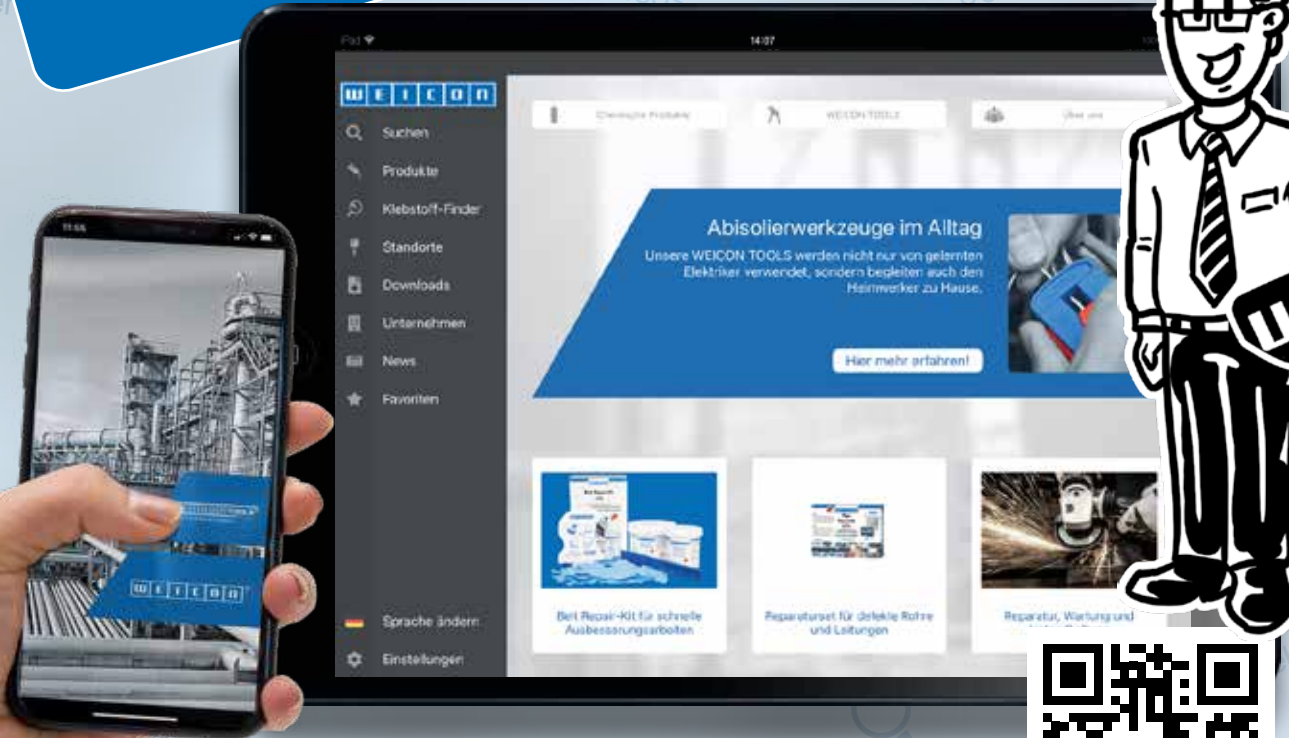

weicon.com/app



You 



www.weicon.com

Dear customers, business partners and friends,

welcome to the WEICON world - or rather to the world of specialty products for various industries and skilled trades! We are happy that you are interested in our company and our wide range of products. More precisely this means that we offer you more than 150 adhesives, numerous technical sprays and many application solutions. All of which are presented in this catalogue.

New products

Every year, we add new high-quality products to our range. You, our customers, are our greatest inspiration for these. Your applications and requirements from various industries motivate us every day to create the best possible solutions.

This year, the new products include, for example, a permanently elastic sealant with fire resistance, a casting compound with crystal-clear curing, or a stainless steel care spray with NSF certification.



Always there for you

And which one is the right solution for you? Don't worry. We'll be right by your side when it comes to choosing the right product! Our medium-sized family business has been well-known in the world of adhesives for its various services and expertise for more than 70 years.

Whether in person, by phone, video conference or WhatsApp chat - we are always there for you, anywhere and anytime!

Supplier of the Year

The professional association of technical retailers 'VTH Verband Technischer Handel e. V.' is also convinced of our exceptional range of services. The association and its members of the technical retail awarded us the title "Supplier of the Year" in the product group of adhesives for a good reason. It is always nice to see that the effort we put into creating a good and lasting cooperation is appreciated.

Because we at WEICON believe in close connections.

Ann-Katrin Weidling

Ann-Katrin Weidling
Managing Director

Ralph Weidling

Ralph Weidling
CEO



Management System
ISO 9001:2015
ISO 14001:2015

www.tuv.com
ID 9108636595



Content	Page
We are WEICON	6-17
2-Component Adhesives and Sealants	18
Epoxy Resin Systems	20
- Plastic Metal	20-31
- Pipe Repair-Kit	32
- Belt Repair-Kit	33
- Emergency Repair Kits	34-35
- Repair Sticks	36-40
- Repair Tapes	41
- Epoxy Adhesives	42-45
Polyurethane Systems	46-49
Structural Acrylic Adhesives	50-57
1-Component Adhesives and Sealants	58
Anaerobic Adhesives and Sealants - WEICONLOCK®	60-79
Gasket Maker	80
Permanently Plastic Universal Sealant - Plast-o-Seal®	81
Thread Sealing Cord DF 175	82
Threadlocking Varnish	83
Cyanoacrylate Adhesives - Contact	84-91
O-Ring Bonding Set	92
Elastic Adhesives and Sealants	96
MS-Polymers - Flex 310 M®	99-107
Polyurethanes	108
Silicones	110-111
Mounting Tapes	118-119
Contact Adhesive - GMK 2410/2510	120-121



Catalogue Content

Content	Page
Technical Sprays	122
Surface and Anti-Corrosion Coatings	124-131
Cleaners and Degreasers	132-137
Protection and Care	138-139
Solvents and Release Agents	140-143
Lubricating and Multifunctional Oils	144-147
Adhesive Lubricants and Grease Sprays	148-149
Assembly Sprays	150
Adhesive Sprays	151
Leak Detection Sprays	152
Crack Testing Agent	153
Special Sprays	154-155
Technical Sprays for Sensitive Areas	156-157
Technical Liquids	160
Surface and Anti-Corrosion Coatings	162-163
Cleaners and Degreasers	164-167
Protection and Care	168-169
Solvents and Release Agents	170-171
Lubricating and Multifunctional Oils	172-175
Special Liquids	176
Accessories	177
Assembly Pastes	180
Anti-Seize	180-185
Lubricants	186
Allround Lubricant	186-191
WEICON TOOLS®	192
Cable Strippers	196-197
Wire Strippers	198-201
Stripping Tools	202-205
Multi-Purpose Strippers	206-209
Special Tools	210-213
Tool Sets	214-215
Spare Parts and Sales Aids	216-217

Other	218
Ancillary Products and Accessories	218-219
Application Areas	220
Product Presentation	222-225
References and Certificates	226-227
WEICON Off Shore - Transport of an Oilrig	228-229
Bike Care Set	230



Note: Any product specifications and recommendations given herein must not be seen as guaranteed product characteristics. They are based on our laboratory tests and on practical experience. Since individual application conditions are beyond our knowledge, control and responsibility, this information is provided without any obligation. We do warrant the continuously high quality of our products being free from defects in accordance with and subject to our General Sales Conditions. However, own adequate laboratory and practical tests to find out if the product in question meets the requested properties are recommended. A claim cannot be derived from them. The user bears the only responsibility for non-appropriate or other than specified applications.

Technical changes reserved.

© Re-printing, duplication, also partly, only after prior written agreement of company WEICON GmbH & Co. KG. • WEICON Catalogue Version 1.22



Fast and individual service

- reaction time guaranteed (24h)
- trained specialists
- laboratory service
- individual solutions
- your personal contact person

Strong sales support

- visits to customers of the trading partners
- bonding tests and selection of adhesives
- individual product trainings
- label service
- application videos

Process-oriented organization

- certificate according to DIN EN ISO 9001:2015
- large range of products
- high product availability
- next day delivery
- online support
- certificates and safety data sheets

Worldwide sales network

- diversity of languages 30 languages worldwide
- nine branches
- over 1.200 trade partners worldwide
- over 40 exhibitions worldwide
- you find us and our products in 120 countries

**FAST.
COMPETENT.
RELIABLE.**



At any location!



We Are WEICON



Family-owned since 1947

1947
Foundation of
P.W. Weidling & Sohn

1950
Move to Engelstraße,
Münster

1957
Gerd Weidling joins
the company

The company changes
to a limited partnership

1958
First participation in the
Mining Exhibition in
the German city of Essen

1959
First participation in the
Hanover Exhibition

1960
Relocation of the company
to Schleibrüggenkamp
in Münster

1964
Gerd Weidling takes
over the company management

1967
Introduction of the new
product line Stripping Tools

1969
New building of the company
headquarters at An der
Kleimannbrücke in Münster

1987
Ralph Weidling joins
the company

Introduction of WEICONLOCK®
Anaerobic Adhesives

1947
-
1987

1993
New building of the company
headquarters at Königsberger
Straße 255 in Münster

1997
Start of the cooperation
with company Willteco B.V.

First off-shore project: Securing of
the transport of an oilrig in Portugal

2000
German Federal Award for Duo-
Crimp No.300 as an outstanding
innovative achievement

Ralph Weidling takes over
the company management

2002
Change of name from
P.W. Weidling & Sohn to WEICON

2004
Start of the cooperation with the
German Fraunhofer
Institute (IFAM)

2005
Foundation of WEICON Middle
East LLC in Dubai, U.A.E.

Innovation Award of the German
Industry for WEICON Plastic
Metal RFC

2006
Patent for the
Pen-Systems

Extension of the
headquarters at
Königsberger Straße in
Münster

1988
-
2006

2008
Foundation of WEICON Inc.
in Kitchener, Canada

2009
WEICON becomes member
of the German Adhesives
Association (IVK)

2010
Enlargement of the company
premises by acquisition
of a new 15,200 m² lot

2011
Foundation of WEICON
Kimya Sanayi in Istanbul, Turkey

Set-up of the
WEICON Online-Shop

2012
Foundation of WEICON Romania
in Targu Mures, Romania

WEICON participates in 45
exhibitions all over the world

2013
Foundation of WEICON SA,
Muizenberg, South Africa

2014
WEICON Adhesive Finder
WEICON Catalogue

2015
WEICON App
Foundation of WEICON South
East Asia in Singapore
1st WEICON International
Meeting in Dubai

2007
-
2015

2016
10 year WEICON Pen-System

Foundation of WEICON
Czech Republic

Beginning the expansion of the
headquarters in Münster

2017
ISO certification

Foundation of WEICON Ibérica S.L

2018
Foundation of WEICON Italia S.r.l.
in Genoa, Italy

Completing the expansion of the
headquarters in Münster

2019
WEICON has been exhibiting at
Hannover Messer for 60 years

First place top employer among
medium-sized companies 2019

2020
Expansion of the
headquarters in Münster

Expansion of our
training laboratory

Reddot winner

Ann-Katrin Weidling joins the
company management

2021
Acquisition of the company Jeln GmbH
Schwalmtal as of January 1st, 2022

Expansion of the adhesive range
with focus on epoxy resins

Award "Supplier of the Year 2021" in the
field of Adhesive Bonding Technology

2016
-
2021



since 2005

WEICON Middle East

On March 1st 2005, our first branch office, WEICON Middle East LLC, was founded in Dubai in the United Arab Emirates.

Meanwhile, more than 750 customers are supplied and supported by the WEICON Middle East team. Adhesive specialists, trained at the Fraunhofer Institute in Bremen (Germany), flexibility and extremely short delivery times are just a few of the many strengths of our team in the United Arab Emirates. Even at summer temperatures of up to +45°C, over 1.000.000 different WEICON products have been sold and shipped to our customers in the region.

The following countries are currently supported by the WEICON team in Dubai: United Arab Emirates, Saudi Arabia, Bahrain, Kuwait, Oman, India, and eleven countries in East Africa. The branch office has an area of approx. 1.100 sqm. Up to 150 pallets with WEICON products can be stored in Dubai. This enables us to guarantee that our customers are supplied locally, quickly and reliably with our products.

Thorsten Lutz and his team are responsible for the distribution of WEICON products and the technical support of our customers in the entire Gulf region. The team at WEICON Middle East consists of twelve employees, six of whom work as field sales representatives.



WE ARE WEICON

SIMPLY FIND SOLUTIONS.

WEICON Middle East L.L.C.
 Jebel Ali Ind Area 1 · P.O. Box 118 216 · Dubai · United Arab Emirates
 phone +971 4 880 25 05
 info@weicon.ae
 www.weicon.ae

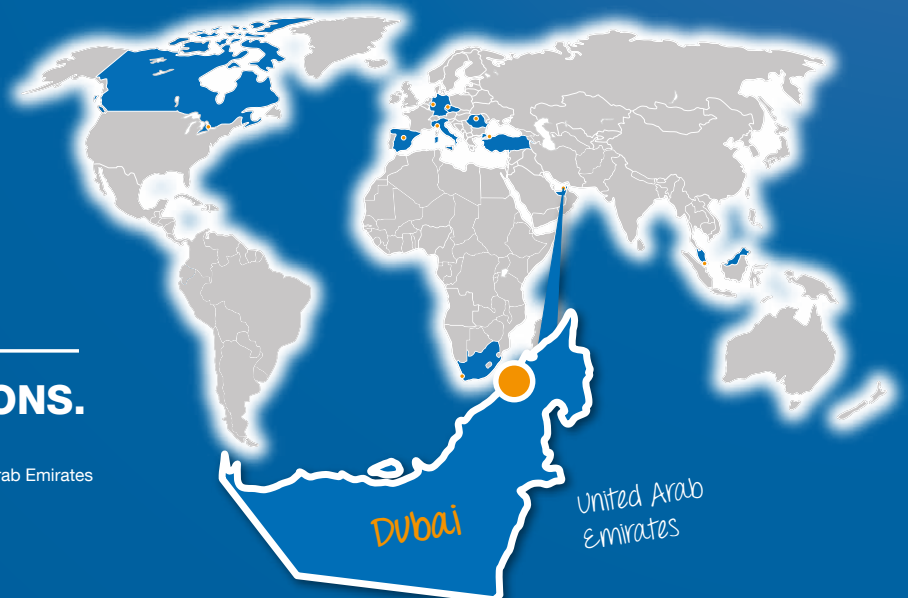

Since 2008



WEICON Inc.

Since September 1st 2008, WEICON is represented in North America by WEICON Inc. in Kitchener, Ontario, Canada.

We supply customers in the most important branches of industry of the Canadian economy, e.g. production and manufacturing, mining and the oil and natural gas industry, with our products.

WEICON Inc. has office and storage space of approximately 320 sqm. More than 30.000 WEICON articles intended for our customers in North America are stored here at 50 pallet stations and on additional shelf space.



WE ARE WEICON

SIMPLY FIND SOLUTIONS.

WEICON Inc.
 20 Steckle Place · Unit 20 · Kitchener · Ontario N2E 2C3 · Canada
 phone +1 877 620 8889
 info@weicon.ca
 www.weicon.ca



WEICON®

Since 2011

WEICON Türkiye

Since April 2011, WEICON has been operating a branch office in Istanbul, Turkey. WEICON Kimya Sanayi Tic. Ltd.Şti. provides support for our customers on the Bosphorus.

With its millions of inhabitants between Europe and Asia, Istanbul is the ideal location for our branch office in Turkey. Our customers and partners in neighbouring countries are supplied with WEICON products from there as well.

The branch office has a large storage area. This assures that our products are available and enables us to guarantee that customers always receive our products quickly.

The team of the branch office under the leadership of Tolga Aksöz is responsible for providing our customers in the region with service and support.



BİZ WEICON'UZ

KOLAY ÇÖZÜM

WEICON Kimya Sanayi Tic. Ltd. Şti.
Orhan Gazi Mahallesi 16. Yol Sokak No: 6
34517 Hladimköy-Esenyurt · İstanbul · Türkiye
phone +90 212 465 33 65
info@weicon.com.tr



Since 2012

WEICON Romania

Our branch office in Romania was founded in March 2012. In 2013, it has been relocated to a new building.

The registered office of WEICON Romania has been located near Targu Mures in the heart of Romania since November 2013. Our employees in Targu Mures currently support numerous customers throughout Romania.

The warehouse stocks the whole Weicon product range, which ensures that customers are supplied quickly and flexibly with our products.



**SUNTEM
WEICON**

PUR ȘI SIMPLU SOLUȚII

WEICON Romania SRL
Str. Podului Nr. 1 · 547176 Budiu Mic (Targu Mures) · Romania
phone +40 (0) 3 65 730 763
office@weicon.com

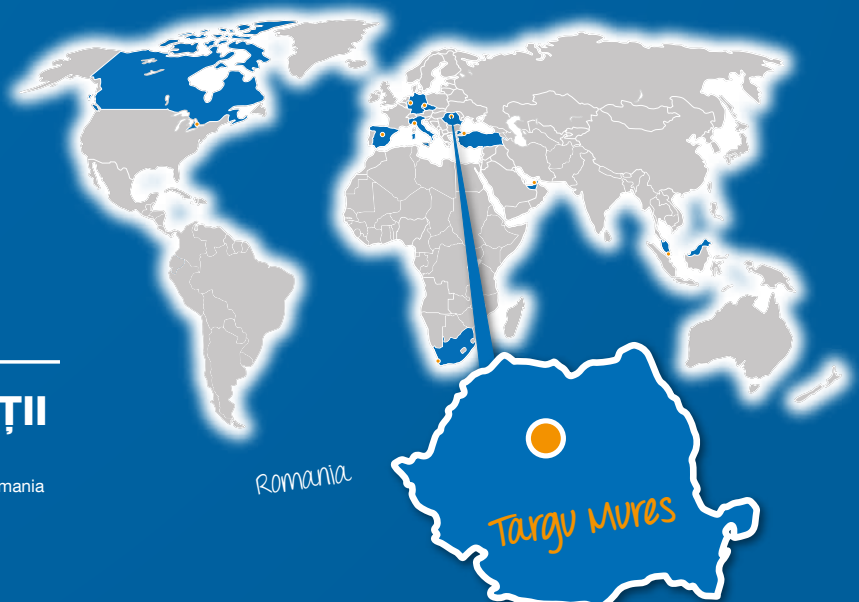

WEICON SA

In November 2013, we founded our African subsidiary WEICON SA Pty Ltd. in Muizenberg near Cape Town

Branch Manager, Peter Leibbrandt, oversees a team of ten well-trained employees including sales representatives in Johannesburg, Durban, Port Elizabeth and Cape Town.

This way, we can ensure that our customers receive the best and direct service from our team.

In addition to South Africa, our office in Cape Town also serves the neighbouring countries of Botswana, Zimbabwe, Zambia and Namibia.

Our flexibility and a very short delivery time are our strengths and distinguish us from other competitors on the market.

Our branch has an area of approx. 220 sqm. The warehouse in Muizenberg has space for up to 45 pallets of WEICON products. This enables us to guarantee that our customers are supplied with products quickly and reliably by the WEICON team on site.

WE ARE WEICON

SIMPLY FIND SOLUTIONS.

WEICON SA (Pty) Ltd
 Unit No. D1 · Enterprise Village · Capricorn Drive · Capricorn Park
 Muizenberg 7945 (Cape Town) · South Africa
 phone +27 (0) 21 709 0088
 info@weicon.co.za



since 2013 

WEICON South East Asia

since 2015

WEICON South East Asia Pte. Ltd. – our branch in Singapore.

At the end of 2015, we opened our international branch in Singapore. The team of our branch office is responsible for the support of our customers in South East Asia.

Our location enables us to quickly react to growing demands and to support the interesting and challenging projects in this region.

Thanks to our team, our on-site warehouse and our network of local distributors, we can ensure fast delivery and personal service.



**WE ARE
WEICON**

SIMPLY FIND SOLUTIONS.

WEICON South East Asia Pte Ltd
7 Soon Lee Street · #01-11 iSpace · Singapore 627608
phone (+65) 6710 7671
info@weicon.com.sg





since 2016



WEICON

Czech Republic

In March 2016, we founded our 7th international branch in Teplice in the north of the Czech Republic.

The Czech Republic is a very interesting market with great economic potential. The country has been member of the European Union since May 2004. Now, 13 years later, it is one of the most developed industrial nations in Central and Eastern Europe. The Czech economy is strongly oriented towards the industry, in particular the automotive industry, metalwork and engineering, the chemical industry and the food and beverage industry. This provides a strong market for our products.

WEICON Czech Republic s.r.o. is the name of our branch. Its headquarters are located in Teplice, in the north of the Czech Republic close to the Czech-German border. The branch is managed by the local manager Vladimír Dufek. Since 1993, German entrepreneurs have invested almost 20 billion euros in the Czech Republic. Germany is the most important trading partner of the country, almost a third of the foreign trade are business deals with Germany. Ahead of Russia, the Czech Republic holds the 12th place of Germany's trading partners (source: Federal Statistical Office). With the positive development of recent years, the strong economic position within Europe and the third lowest unemployment rate in the EU, the Czech Republic was able to convince us of its local advantages.



**MY JSME
WEICON**

JEDNODUŠE NAJDĚTE ŘEŠENÍ

WEICON Czech Republic s.r.o.
Teplická 305 · CZ-417 61 Teplice-Bystřany · Česká republika
phone +42 (0) 417 533 013
info@weicon.cz
www.weicon.cz



since 2017

WEICON Ibérica S.L.

In early 2017, we founded our 8th international branch in Madrid, the capital of Spain.

The head of our branch, Alejandro González Cámara, and his team are responsible for customer services as well as customer acquisition in the Iberian Peninsula.

Spain is one of the most important European industrial nations and it is very important for us to be present there. Significant economic branches within the state are the foodstuffs, automotive and mechanical engineering industry. These areas are continuously expanding and indicate good growth figures. We benefit from this development through our new branch in Spain.



SOMOS WEICON

ENCONTRAR FÁCILMENTE SOLUCIONES

Weicon Ibérica Soluciones Industriales S.L.

Av. de Somosierra 18, Nave 6 · San Sebastián de los Reyes · 28703 Madrid
phone +34 91 47 99 734
info@weicon.es





since 2018

WEICON Italia S.r.L.

In October 2018, we founded our 9th international branch in Italy.

Weicon Italia s.r.l., which is the name of the new branch, is situated in the Italian port city Genoa on the country's northwest coast. The branch is run by the local managing director Davide Merlo. "We have been collaborating with Davide very successfully since 2014. During this time, he worked as a field sales representative in Italy for us. By founding our new international branch, we will consolidate and further establish our position in the Italian market. We are looking forward to a very promising future in Italy," says Ralph Weidling.

"Italy is a very interesting market for us, which we have been involved in for quite some time now. The country is one of the biggest industrial nations in the world and it is extremely important for us to be present there. Italy's most important economic sectors are the machine, aircraft and vehicle construction industries, the shipbuilding industry as well as the chemical and textile industry, and the manufacturing of electronic products.

Therefore, Italy is a big market for our products. With our new branch in Northern Italy, we want to take advantage of this positive situation," Weidling further explains.



NOI SIAMO WEICON

TROVARE LA SOLUZIONE IN MODO SEMPLICE

WEICON Italia S.r.L.
Via Capitano del Popolo, 20 · 16156 Genova · Italy
phone +39 (0) 329 235 9592
info@weicon.it



International WEICON Partners



 **Weikang (Shanghai) Chemical Tech. Co.,Ltd.**
 B63 F4, Building 5, No.2278
 Zhaochong Gonglu, Qingpu District
 Chonggu Town, Shanghai

Room 2045 Floor 20,Jingxin Building
 Dongsanhuan North Road 2A, Chaoyang District, Beijing

0086 10 8449 3113
 0086 400 762 7688
www.weiconchina.com



 **ALTIS Slovakia s.r.o.**
 Záturčianska 66, 036 01 Martin
 phone: +421 -(0)43-4220 258
www.weicon-sk.sk

 **CJSC UNIT MARK PRO**
 34, build.10, Marksistskaya ul.
 109147 Moscow
 phone: 007 495 748 0907
www.umpgroup.ru



 **Qatari Industrial Equipment W.L.L.**
 Barwa Commercial Avenue, Sayer 15-C 204,
 2nd Floor, Doha-Qatar, P.O.BOX 9377
 phone: +974 44600044 / +974 40350350
www.qatari-industrial.com





Plastic Metal

Product	Page
WEICON A	21
WEICON B	21
WEICON C	21
WEICON BR	22
WEICON F	22
WEICON F2	22
WEICON HB 300	22
WEICON Ceramic BL	23
WEICON GL	23
WEICON GL-S	23
WEICON Ceramic HC 220	23
WEICON SF	24
WEICON TI	24
WEICON Ceramic W	24
WEICON WP	24
WEICON UW	25
WEICON HP	25
WEICON Casting Resin MS 1000	26
WEICON Casting Resin Plus 90	26
WEICON ST	26
WEICON WR	26
WEICON WR2	26
Epoxy Resin Putty	27
WEICON CBC - Chocking Backing Compound	30

Repair Kits

Pipe Repair-Kit	32
Belt Repair-Kit	33
Emergency Repair Kits	34-35

Repair Sticks

Repair Stick Steel	36
Repair Stick Aqua	36
Repair Stick Titanium	37
Repair Stick Stainless Steel	37
Repair Stick Multi-Purpose	38
Repair Stick Plastic	38
Repair Stick Wood	38
Repair Stick Copper	39
Repair Stick Aluminium	39
Repair Stick Concrete	39

WEICON Repair Tapes	41
---------------------	----

Epoxy Adhesives

Product	Page
Epoxy Minute Adhesive	42
Epoxy Minute Adhesive Set	42
Aluminium Minute Adhesive	42
Aluminium Minute Adhesive Set	42
Fast-Metal Minute Adhesive	42
Fast-Metal Minute Adhesive Set	42
Easy-Mix S 50	43
Easy-Mix S 50 gelb	43
Easy-Mix Metal	43
Easy-Mix N 5000	43
Easy-Mix N 50	43
Easy-Mix HT 180	43
Easy-Mix HT 250	43
Easy-Mix Mixing and Dosing System	43

Polyurethane Systems

Surface Pre-treatment and Accessories	46
Urethane 45	47
Urethane 60	47
Urethane 80	47
Urethane 85	47
Urethane 90 SF	47
Belt Repair-Kit	47
Easy-Mix PU-90	48
Easy-Mix PU-240	48
Easy-Mix PU Crystal	48

Structural Acrylic Adhesives

RK-1300	51
RK-1500	51
Easy-Mix RK-7300	52
Easy-Mix RK-7000	53
Easy-Mix RK-7100	53
Easy-Mix RK-7100 black	53
Easy-Mix RK-7200	53
Plastic-Bond	53
Plastic-Bond Set	53
Easy-Mix PE-PP 50	54
Easy-Mix PE-PP 45	55

Adhesives / Sealants

Technical Sprays

Technical Liquids

Assembly Pastes

Lubricants

WEICON TOOLS®

Other

2-Component Adhesives and Sealants



möglichst sorgfältig
gut und blasenfrei
(max. 500 U/min.)
Schichtung +/- 2%).
The fillers in the
past 4 minutes
Get a uniform

WEICON
Plastik-Stahl
Plastik-Plastik
WEICON

Adhesives / Sealants

Technical Sprays

Technical Liquids

Assembly Pastes

Lubricants

WEICON TOOLS®

Other

Two-component epoxy resin systems

Add the hardener



Mix resin and hardener thoroughly and bubble-free



Apply mixed components



- ▶ providing fast and durable repairs
- ▶ bondings
- ▶ coatings

Applications

For workshops and maintenance departments in all industries, WEICON Plastic Metal is the ideal product for:

- ▶ repairs on aluminium and light alloy
- ▶ reconditioning and repairing castings, pipes and tanks
- ▶ filling blowholes and microporosities
- ▶ working over shafts, sliding bearings, pumps and housings
- ▶ welding without preheating (wherever welding is problematic or impossible)

In industrial design and manufacturing, WEICON Plastic Metal is used for making moulds and models, in particular:

- ▶ as an aid for making moulds for rubber and injection moulded parts
- ▶ making dies
- ▶ templates and models for pre-production testing
- ▶ lining of cutting tool guides
- ▶ making fixing devices



Now included in every package

Contour Spatula Flexy

Versatile use, e.g. for coating and processing 2C-adhesives. The spatula is perfect for applying adhesives on large or small surfaces. It is made of wear-resistant polyamide.

10953020



Adhesives / Sealants

Technical Sprays

Technical Liquids

Assembly Pastes

Lubricants

WEICON TOOLS®

Other

Epoxy Resin Systems

Plastic Metal

WEICON A



Pasty | steel-filled | certified by DNV

WEICON A has a DNV certificate and is particularly suitable for repair and maintenance work in the maritime industry. The epoxy resin system is highly filled with steel pigments, magnetic and its pasty texture allows application even on vertical surfaces.

It can be used to remove corrosion damage and pitting or to repair holes and blowholes. For example, it can be used to reproduce heavy steel components showing severe damage by corrosion and pitting. In this case, WEICON A provides a real alternative to welding, as the application of the epoxy resin does not cause thermal distortion as in welding. The 2-component system can be used for repairs on tanks and pipes as well as for repairing cracks in engine or pump housings and machine parts. It is ideal for use in sewer systems where pipes and pipelines are exposed to strong media influences.

Other applications include the manufacture of models, moulds, tools and clamping devices. WEICON A can be used in mechanical engineering, in toolmaking, in the cement industry, in power plants, in model and mould making, and in many other industrial sectors.

▶ 0,2 kg ▶ 0,5 kg ▶ 2,0 kg
10000002 10000005 10000020

WEICON B

Pasty | steel-filled | long pot life

The epoxy resin system WEICON B is particularly suitable for detailed reproductions in model and mould making, for the production of tools, templates, gauges and clamping devices, and for filling blowholes and microporosities on castings and steel parts as well as for general repair works where a steel-filled casting compound is advantageous.

The reconstructing of severely damaged steel components with WEICON B causes no thermal distortion of the components and thus no impairment of the metal structure, as for example during weld overlay. Due to the long pot life and curing time, larger quantities can be applied per working step. It can be used in mechanical engineering, toolmaking, model and mould making as well as many other areas.

▶ 0,2 kg ▶ 0,5 kg ▶ 2,0 kg
10050002 10050005 10050020

WEICON C

Flowable | aluminium-filled |
temperature-resistant up to 220°C (428°F)

WEICON C is a temperature-resistant and flowable epoxy resin system especially for industrial use. The adhesive is non-corrosive, anti-magnetic and cures practically without shrinkage.

WEICON C is particularly suitable as an adhesive for large-surface applications, for the casting of moulds, and for the production of fixing devices and tools (e.g. injection moulds). It can be used in tool and mould making as well as in many other industrial areas, which are exposed to high thermal stress.

▶ 0,2 kg ▶ 0,5 kg ▶ 2,0 kg
10100002 10100005 10100020

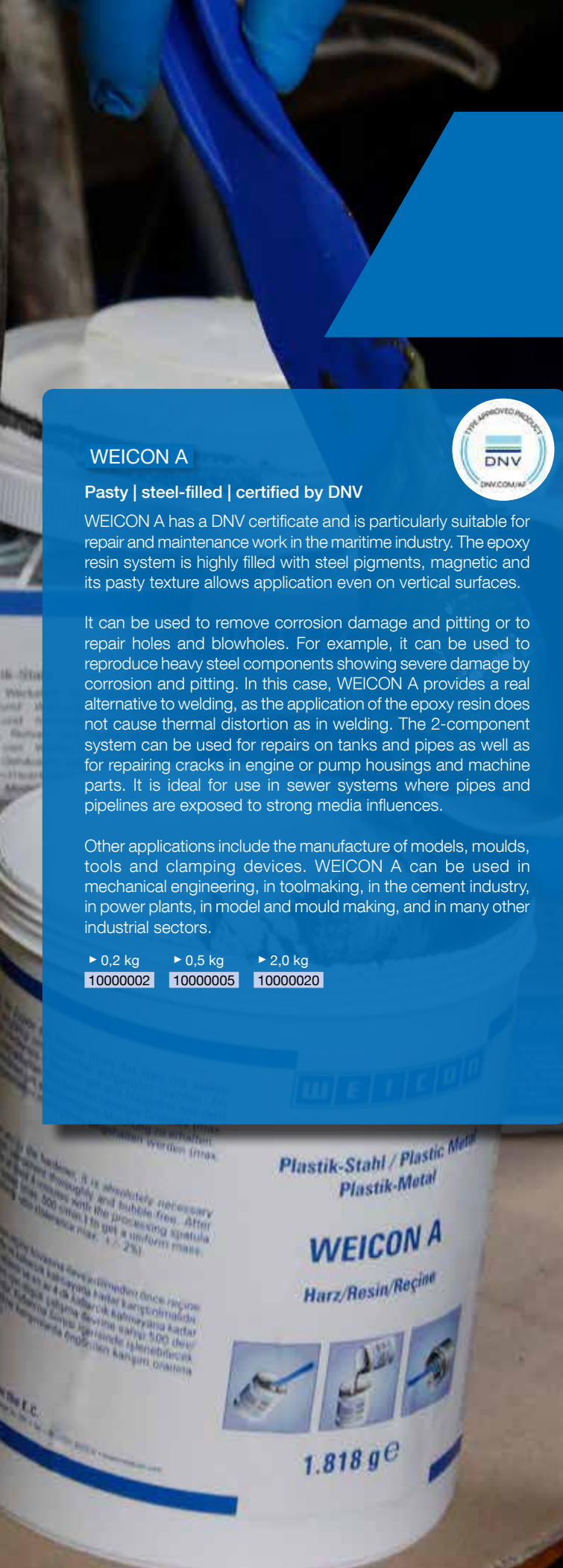



VIDEO



WEICON BR

Pasty | bronze-filled | non-corrosive

The epoxy resin system WEICON BR is particularly suitable for filling blowholes and for repairing and reconditioning bronze parts and bronze castings.

It can be used in the entire marine and shipping industry as well as in many other industrial sectors. For example, it can be used to reproduce bronze components that show severe damage. Thereby, WEICON BR offers a real alternative to costly brazing.

- ▶ 0,2 kg ▶ 0,5 kg ▶ 1,6 kg
- 10420002 10420005 10420020

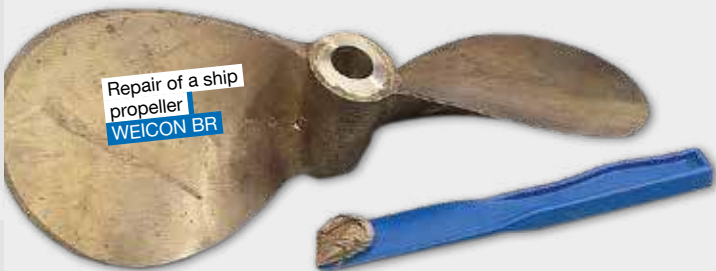

WEICON F

Pasty | aluminium-filled | non-corrosive

WEICON F is especially suitable for applications on parts made of aluminium, its alloys, magnesium, and other light metals.

WEICON F can be used for cost-effective repairs of all kinds, for filling shrinkage defects in light metal castings, and for the reconstruction of components. The epoxy resin system can be used in tool making, model and mould making, and in many other industrial sectors.

- ▶ 0,2 kg ▶ 0,5 kg ▶ 2,0 kg
- 10150002 10150005 10150020

WEICON F2

Flowable | aluminium-filled | non-corrosive

The epoxy resin system WEICON F2 is suitable for the casting of models, moulds and templates, for the repair of porous and damaged castings, for the production of prototypes and holding devices, and for the casting of dies to verify accuracy.

It can be used in toolmaking, model and mould making and many other areas of industry.

- ▶ 0,2 kg ▶ 0,5 kg ▶ 2,0 kg
- 10200002 10200005 10200020



WEICON HB 300

VIDEO



Pasty | steel-filled | high-temperature-resistant up to 280°C (536°F) for short periods of time

WEICON HB 300 is pasty, steel-filled and resistant to high temperatures up to 200°C (392°F) (for short periods up to 280°C/536°F) and is processed in a mixing ratio of 1:1.

The epoxy resin system is also suitable for applications on vertical surfaces and can be used for repairs and adhesive bonding of castings and metal parts, for filling blowholes, for repairing damages on containers, car bodies and machine parts, and for sealing pumps and pipes. The product can be used in mechanical and industrial engineering, in equipment engineering, and in many other areas of industry.

- ▶ 0,2 kg ▶ 0,5 kg ▶ 1,0 kg
- 10450002 10450005 10450010

Adhesives / Sealants
 Technical Sprays
 Technical Liquids
 Assembly Pastes
 Lubricants
 WEICON TOOLS®
 Other

Epoxy Resin Systems

Plastic Metal

WEICON Ceramic BL



Flowable | mineral-filled | extremely wear-resistant | temperature-resistant up to +180 °C (+356 °F)

WEICON Ceramic BL is filled with silicium carbide and zirconium silicate, resistant to chemicals and offers extreme wear protection as well as high abrasion resistance.

The epoxy resin system is particularly suitable for lining heavily stressed pump casings, as wear protection for slide bearings, chutes, funnels and pipes, and for the repair of castings, valves and fan blades. The product can be used in mechanical and plant engineering, apparatus engineering and many other areas of industry. Wear-resistant top coating for all plastic metal types.

WEICON Ceramic BL is also well suited for creating a system structure in combination with WEICON GL. Due to the different colours of the two wear protection systems, the degree of wear can be easily determined during visual inspections.

▶ 0,2 kg 10400002 ▶ 0,5 kg 10400005 ▶ 2,0 kg 10400020

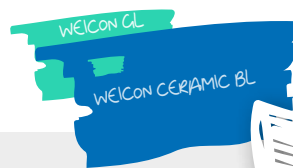

WEICON GL

Sprayable | mineral-filled | short processing time | extremely wear-resistant | temperature-resistant up to +180 °C (+356 °F)

The epoxy resin system WEICON GL provides high abrasion resistance and serves as wear protection for heavily used surfaces. It is flowable, has a high initial strength, is mineral-filled, and resistant to chemicals.

It is particularly suitable for lining heavily stressed pump casings, as wear protection for slide bearings, chutes, funnels and pipes and for the repair of castings, valves and fan blades.

The product can be used in mechanical and plant engineering, in equipment engineering, and in many other areas of industry. WEICON GL is also well-suited for creating a system structure in combination with WEICON Ceramic BL. Due to the different colours of the two wear protection systems, the degree of wear can be easily determined during visual inspections.

▶ 0,2 kg 10700002 ▶ 0,5 kg 10700005 ▶ 1,0 kg 10700010

WEICON GL-S NEW



Flowable | mineral-filled | wear protection | control layer | temperature-resistant up to +180 °C (+356 °F)

The epoxy resin system WEICON GL-S provides high abrasion resistance and serves as wear protection for heavily used surfaces. It is flowable, spreadable (can be applied with a paint brush), has a high initial strength, is mineral-filled, and resistant to chemicals. WEICON GL-S is also well-suited for creating a system structure in combination with WEICON Ceramic BL.

Due to its long recoat time of five hours, GL-S is especially suitable for applications at higher ambient temperatures or for larger surfaces. The different colours of Ceramic BL (blue) and GL-S (dark green) make it easy to determine the degree of wear during visual inspections. It is particularly suitable for lining heavily stressed pump casings, as wear protection for slide bearings, chutes, funnels and pipes, and for the repair of castings, valves and fan blades.

The product can be used in mechanical and plant engineering, in equipment engineering, and in many other areas of industry.

▶ 0,2 kg 10705002 ▶ 0,5 kg 10705005 ▶ 2,0 kg 10705020



WEICON Ceramic HC 220 NEW

Flowable | ceramic-filled | wear protection | surface coating | temperature-resistant up to +220 °C

The epoxy resin system WEICON Ceramic HC 220 provides high abrasion resistance and serves as wear protection for heavily used surfaces. It is temperature-resistant up to +220 °C, flowable, ceramic-filled, resistant to chemicals and has a high adhesive strength. Ceramic HC 220 can be easily processed with a paint brush and applied to large surfaces.

The epoxy resin systems is non-corrosive, anti-magnetic and cures practically without shrinkage. The product can be used in mechanical and plant engineering, in equipment engineering, and in many other areas of industry where high temperature loads are part of daily work.

▶ 0,2 kg 10120002 ▶ 0,5 kg 10120005 ▶ 2,0 kg 10120020

IN COMBINATION WITH WEICON CERAMIC BL
PERFECT AS CONTROL LAYER

SPRAYABLE

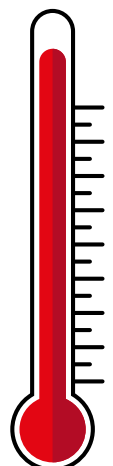



Maintenance of a vibrating plate in mining
WEICON WP

WEICON SF



Pasty | steel-filled | certified by DNV

WEICON SF has a DNV certificate and is particularly suitable for quick repairs and repair work on leaking pipes, housings and gears, for anchoring and for the production of clamping devices.

The epoxy resin system can be used in mechanical engineering, tool production, model and mould making, the maritime industry and many other areas.

- ▶ 0,2 kg ▶ 0,5 kg ▶ 2,0 kg
- 10250002 10250005 10250020

WEICON WP

Pasty | high strength | ceramic-filled | extremely high resistance against abrasion and wear | residual elasticity and impact-resistant

WEICON WP serves as protection for surfaces subject to heavy wear. A coating with the epoxy resin system offers high resistance to wear and abrasion and is extremely resistant to chemicals.

WEICON WP prevents metal loss and, depending on the application, replaces previously used wear-resistant alloys, ceramic tiles or rubber lining as well as welded metal coatings. It can be used both for the reconditioning of worn metal surfaces and as a wear-resistant coating. A particularly high level of protection is achieved when wear is caused by laterally impacting particles.

- ▶ 0,2 kg ▶ 2,0 kg ▶ 10,0 kg
- 10490002 10490020 10490100

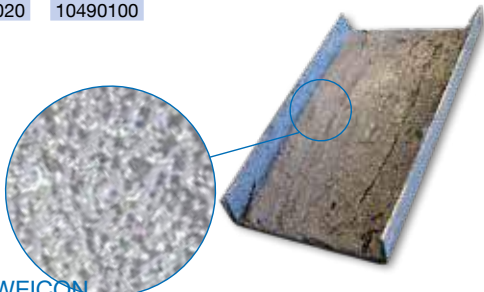

WEICON TI

Pasty | titanium-filled | temperature-resistant up to +200°C (+392°F) (briefly up to +260°C/+500°F)

WEICON TI has high pressure resistance and very good chemical resistance. It is particularly suitable for repairs of pumps, valves, wear plates, ball bearing seats, shafts and propellers, and for lining pump housings and slide bearings.

The epoxy resin system can be used in mechanical and industrial engineering, in equipment engineering, and in many other areas of industry.

- ▶ 0,2 kg ▶ 0,5 kg ▶ 2,0 kg
- 10430002 10430005 10430020

WEICON Ceramic W

Pasty | mineral-filled | wear-resistant

The epoxy resin system WEICON Ceramic W offers high wear protection and high abrasion resistance. It is resistant to chemicals and has a high temperature resistance up to 200°C (392°F); for short periods of time even up to 260°C (500°F).

Ceramic W is non-drip, can be processed with a spatula, and applied on vertical surfaces or even overhead. It is suitable for adhesive bonding or lining aluminium oxide bricks in mill construction, for lining heavily stressed pump housings, as wear protection for slide bearings, slides and pipes, and wherever the use of dark products is not desired for visual reasons. It can be used in mechanical and industrial engineering, in mill construction, equipment engineering, and many other areas of industry.

- ▶ 0,2 kg ▶ 0,5 kg ▶ 2,0 kg
- 10460002 10460005 10460020



Epoxy Resin Systems

Plastic Metal

WEICON UW

Pasty | mineral-filled | adheres to wet and moist surfaces

WEICON UW is a 2-component epoxy resin system with fast curing. It is particularly suitable for repairs and repair works, for example on pipes, pumps, tanks, and containers.

Due to its special formulation, WEICON UW also offers very good adhesion when bonded under water. Therefore, it can be used in the entire marine and shipping sector, in sewage plants, and wherever moisture and wetness may cause problems with the adhesion.

- ▶ 0,2 kg ▶ 0,5 kg ▶ 2,0 kg
- 10440002 10440005 10440020



WEICON HP

Pasty | mineral-filled | shock-resistant | adheres to wet and moist surfaces

WEICON HP is a 2-component epoxy resin system with high adhesive strength, enormous impact strength as well as high residual elasticity and abrasion resistance.

Due to its high elongation at break and the pasty texture of the epoxy resin, WEICON HP can be used for adhesive bonding, repairs, and for lining heavily used equipment. Particularly on wet and moist surfaces, the adhesive is able to build up a very good adhesion to various materials.

- ▶ 0,2 kg ▶ 0,5 kg ▶ 2,0 kg
- 10390002 10390005 10390020



Characteristics		Plastic Metal UW
Pot life		30 min.
Handling strength		16 h
Complete curing		48 h
Bond	Use	Plastic Metal UW
above water	above water	23,8 N/mm ²
above water	under water	20,5 N/mm ²
under water	under water	15,3 N/mm ²

Adhesive bonding following the DIN 1465 standard on V2A steel, sand-blasted, after storage for 7 days at 20°C.

Ideal water temperature for processing
WEICON UW: +20°C to +40°C



Adhesives / Sealants

Technical Sprays

Technical Liquids

Assembly Pastes

Lubricants

WEICON TOOLS®

Other



WEICON Casting Resin MS 1000

Liquid | unfilled | low viscosity

WEICON Casting Resin MS 1000 is a transparent and very flowable epoxy resin system with high mechanical strength. It is suitable for a wide range of applications.

MS 1000 adheres well to metal, wood, rigid foam and many plastics. It can be used for large-surface adhesive bonding or for laminating composite threaded bushes and screws. Due to its low viscosity, the epoxy resin system is also suitable for the casting of electric components.

It can be used for the production of fibre composites, in tool and mould making, in the electrical industry, in machine construction, and in many other industrial fields. MS 1000 shows good wetting and penetration results of glass fabric and is therefore well-suited for laminating glass, aramid and carbon fibre for the production of fibre-reinforced components. It can also be easily combined with different fillers (powdery, fibrous, fabric).

- ▶ 0,2 kg ▶ 0,5 kg ▶ 1,0 kg
- 10520002 10520005 10520010



VIDEO

WEICON WR

Liquid | steel-filled | wear-resistant

WEICON WR is suitable for areas where metal parts are subject to heavy wear due to friction. For example, the epoxy resin system can be used for repairs and for casting around shafts, for casting bearings, cutting and punching tools, for the production of castings, copy milling models and moulds, for underpouring machines and foundations, and as a wear-resistant base layer before the final coating with WEICON Ceramic BL.

It can be used in mechanical engineering, toolmaking, model and mould making, and in many other industrial sectors.

- ▶ 0,2 kg ▶ 0,5 kg ▶ 2,0 kg
- 10300002 10300005 10300020

WEICON Casting Resin Plus 90 NEW

Casting compound | crystal clear | low viscosity | up to 90 mm layer thickness

The epoxy resin system WEICON Casting Resin Plus 90 is a casting compound which cures crystal clear. Its special formulation allows high layer thicknesses up to 90 mm. The compound can also be used to coat sensitive surfaces and protects against damages. The casting resin has a low viscosity, high mechanical stability, is impact-resistant, has a high moisture resistance and a good UV resistance. It can be processed very well manually and mechanically - whether by grinding, filing or drilling.

Casting Resin Plus 90 is particularly suitable for applications with high visual requirements. Whether in the production of design objects, furniture construction, trade fair construction, yacht and boat building, wood processing, arts and crafts, or gardening and landscaping - the casting resin is suitable for a wide range of applications.

- ▶ 0,2 kg ▶ 0,5 kg ▶ 1,0 kg
- 10523002 10523005 10523010

WEICON WR2

Pasty | mineral-filled | wear-resistant | high abrasion resistance

WEICON WR2 is a pasty wear protection and is particularly suitable for areas where the application of casting compounds is not possible, such as repairs of conveyor systems, guide rails and slideways. The epoxy resin system can also be used to prevent wear on metal surfaces which are exposed to high abrasion and erosion. It serves as a wear-resistant base layer before the subsequent coating with WEICON Ceramic BL.

WR2 can be used in mechanical and industrial engineering, in equipment engineering, and in many other industrial sectors.

- ▶ 0,2 kg ▶ 0,5 kg ▶ 2,0 kg
- 10350002 10350005 10350020

WEICON ST

Thixotropic | can be applied with a spatula | metal-filled | non-corrosive

WEICON ST is suitable for versatile repairs and repair works on machine parts and workpieces made of stainless steel, such as tanks, pipes, containers, funnels, and flanges.

The epoxy resin system can be used in the chemical industry, in the entire marine and shipping sector, in sewage plants, in the paper industry, and in many other areas.

- ▶ 0,2 kg ▶ 0,5 kg ▶ 2,0 kg
- 10410002 10410005 10410020



Repair of a water boiler
WEICON WR

Epoxy Resin Systems

Plastic Metal

Applications Plastic Metal



Reconditioning of a bearing seat for a cement combustion chamber / cement kiln, weight approx. 500 t
WEICON HB 300



Repair of a hairline crack on a pump housing
WEICON WR 2



Dedusting filter cartridges for air filtration at workplaces
WEICON C



Roller in a paper factory. Repair of unevennesses and voids created through wear
WEICON C

Epoxy Resin Putty

high-strength | versatile | temperature-resistant up to 200 °C

WEICON Epoxy Resin Putty is a metal-free, kneadable 2-component compound. The product can be used for various purposes. It is suitable for the reconditioning and repair of castings, the rebuilding of shafts, slide bearings, pumps and housings, the renewal of defective threads, the production of templates and models, and for repair works on aluminium, light metal and injection moulded parts. The compound can be used to seal pipes and tanks and to fix screws and hooks. It can be used to remove corrosion damage and pitting or to repair holes and blowholes.

Epoxy Resin Putty adheres particularly well to all metals and also to ceramics, glass, stone, concrete, wood, rubber and many plastics. When cured, WEICON Epoxy Resin Putty is machinable, paintable and resistant to petrol, oil, esters, salt water and most acids and alkalis. It has a high-temperature-resistance up to +200°C (+392°F), is non-magnetic and non-corrosive. Due to the simple mixing ratio of 1:1 by weight and volume, resin and hardener can be portioned very easily in the desired quantity. WEICON Epoxy Resin Putty can be used in machine construction, tool construction, model and mould making, and in many other industrial applications.

- ▶ 0,1 kg ▶ 0,4 kg ▶ 0,8 kg
- 10500100 10500400 10500800



Basis	epoxy resin
Filler	mineral-filled
Pot life at +20°C (+68°F) (25 g material)	20 min.
Density of the mixture	2,0 g/cm ³
Processing temperature	+15 to +40°C (+59 to +104°F)
Curing temperature	+6 to +40°C (+43 to +104°F)
Colour after curing	green
Gap covering power to max.	20 mm
Capable of bearing mechanical loads (80% strength/+20°C/+68°F) after	2 h
Final strength (100% at +20°C/+68°F) after	5 h
Pressure (DIN EN ISO 604)	80 MPa (11.600 psi)
Shore hardness D (DIN ISO 7619)	85±3
Tensile shear strength (DIN EN ISO 527-2)	19 MPa (2.760 psi)
Temperature resistance	-35 to +200°C (-31 to +392°F)

Technical Data

WEICON Plastic Metal in non-cured condition

	Filler	Texture	Colour	Mixing ratio (Weight %)		Viscosity of the mixture mPa.s	Density of the mixture g/cm³	Max. layer thickness per application mm	Pot life at +20°C (+68°F) (500 g preparation)	Curing time in h	
				Resin	Hardener					Mechanical loads	Final hardness
WEICON A	steel	pasty	dark grey	100	10	1.000.000	3,40	30	60 min.	7	24
WEICON B	steel	flowable	dark grey	100	10	200.000	2,50	30	60 min.	13	24
WEICON BR	bronze	pasty	bronze metallic	100	100	750.000	1,80	12	60 min.	6	12
WEICON C	aluminium	flowable	grey	100	11	35.000	1,60	10	60 min.	6	12*
WEICON F	aluminium	pasty	aluminium metallic	100	20	880.000	1,40	30	60 min.	12	36
WEICON F2	aluminium	flowable	aluminium metallic	100	14	200.000	1,60	10	60 min.	26	72
WEICON HB 300	steel	pasty	dark grey	100	100	1.700.000	2,50	20	30 min.	10	24*
WEICON Ceramic BL	silicium carbide, zirconium silicate	flowable	blue	100	8	23.000	1,80	10	55 min.	8	12
WEICON Ceramic HC 220	silicium carbide, zirconium silicate	flowable	dark grey	100	10	30.000	1,70	10	45 min.	6	10
WEICON GL	mineral-filled	flowable	green	100	20	13.000	1,30	10	30 min.	6	8
WEICON GL-S	silicium carbide, zirconium silicate	flowable	green	100	8	23.000	1,80	10	55 min.	8	12
WEICON Ceramic W	mineral-filled	pasty	white	100	33	600.000	1,60	10	120 min.	9	24*
WEICON SF	steel	pasty	dark grey	100	33	800.000	1,80	10	5 min.	1	6
WEICON ST	stainless steel	pasty	light grey	100	50	550.000	1,70	10	60 min.	9	12
WEICON HP	mineral-filled	pasty	white	100	83	550.000	1,50	10	30 min.	12	36
WEICON TI	titan	pasty	grey	100	33	550.000	1,60	10	120 min.	9	16*
WEICON UW	mineral-filled	pasty	white	100	83	550.000	1,50	10	30 min.	12	36
WEICON WP	ceramic	pasty	grey	100	100	900.000	2,20	20	30 min.	12	36
WEICON WR	steel	liquid	black	100	15	4.000-5.000	2,40	10	40 min.	7	16
WEICON WR2	mineral-filled	pasty	anthracite	100	33	560.000	1,70	20	30 min.	5	12
WEICON Casting Resin MS 1000	unfilled	liquid	transparent, slight inherent colour	100	20	1.200	1,20	10	80 min.	14	24
WEICON Casting Resin Plus 90	unfilled	liquid	crystal clear	100	47	180-230	1,10	90	30-35 h	4 days	14 days

ABRASION RESISTANCES ABRASION MEASUREMENT ACCORDING TO TABER

	Density (g/cm³)	Abrasion volume (cm³)
Steel STW 22	7,9	0,10
WEICON Ceramic BL	1,8	0,17
WEICON WP	2,2	0,21
WEICON Ceramic W	1,6	0,50
WEICON WR	2,4	0,53
WEICON WR2	1,7	0,63
WEICON F	1,7	0,83

The Taber abrasion test according to DIN ISO 9351 is used to determine the abrasion resistance of various material types. For this, two friction wheels grind over the surface of a rotating material sample. To intensify the test, the H18 friction rollers are pressed onto the surface of the material with an additional weight of 1kg. After 1000 rotations, the amount of material ground off is determined.

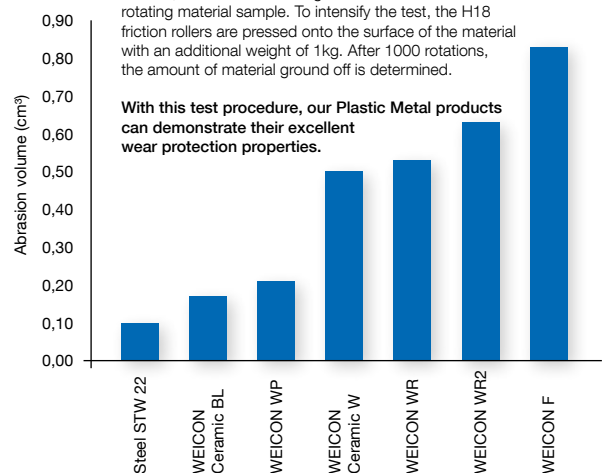

With this test procedure, our Plastic Metal products can demonstrate their excellent wear protection properties.

Epoxy Resin Systems

Plastic Metal

Technical Data

WEICON Plastic Metal in cured condition

	Tensile MPa (psi)	E-Module (Tensile) MPa (KSI)	Compressive MPa (psi)	Flexural MPa (psi)	Shore hardness D	Shrinkage %	Temperature resistance °C (°F)	Thermo forming resistance °C (°F) DIN EN ISO 75-2 (B)	Glass transition temperature (DSC)	
	DIN EN ISO 527-2	DIN EN ISO 604	DIN EN ISO 178	DIN ISO 7619	T _g after curing at room temperature				T _g after tempering at 120 °C	
WEICON A	40 (5.800)	7900 - 8100 (1.150 - 1.170)	80 (11.600)	34 (4.930)	80 ±3	0,010	-35 to +120 (-31 to +248)	+65 °C (+149)	approx. +60°C	+78 °C
WEICON B	43 (6.250)	4100 - 4600 (600 - 670)	106 (15.380)	52 (7.540)	84 ±3	0,10	-35 to +120 (-31 to +248)	+67 °C (+153)	approx. +57°C	+66 °C
WEICON BR	55 (7.980)	7.000 - 7.200 (1.020 - 1.040)	91 (13.200)	35 (5.100)	87 ±3	0,280	-35 to +120 (-31 to +248)	+50 °C (+122)	approx. +47 °C	+48 °C
WEICON C	50 (7.250)	6.400 - 7.500 (930 - 1.090)	174 (25.240)	178 (25.820)	89 ±3	0,07	-35 to +220* (-31 to +428)	+60 °C/+120 °C* (+140/+248)	approx. +58°C	+120 °C
WEICON F	31 (4.500)	4.400 - 5.000 (640 - 725)	66 (9.570)	53 (7.690)	85 ±3	0,12	-35 to +120 (-31 to +248)	+51 °C (+124)	approx. +52 °C	+59 °C
WEICON F2	31 (4.500)	3.200 - 3.400 (465 - 495)	39 (5.660)	26 (3.770)	77 ±3	0,160	-35 to +120 (-31 to +248)	+55 °C (+131)	approx. +52 °C	+53 °C
WEICON HB 300	50 (7.250)	7.000 - 7.200 (1.020 - 1.040)	100 (14.500)	42 (6.100)	85 ±3	0,150	-35 to +200 briefly to +280 (-31 to +392 briefly to +536)	+100 °C* (+212)	approx. +57 °C	+92 °C
WEICON Ceramic BL	59 (8.560)	7.100 - 7.300 (1.030 - 1.060)	116 (16.800)	80 (11.600)	90 ±3	0,130	-35 to +180 (-31 to +356)	+55 °C (+131)	approx. +52 °C	+69 °C
WEICON Ceramic HC 220	51 (7.400)	5.300 - 7.000 (770 - 1.020)	160 (23.210)	83 (12.040)	85 ±3	0,140	-35 to +220 (-31 to +428)	+130 °C (+266)	approx. +50 °C	+130°C
WEICON GL	59 (8.560)	3.300 - 3.700 (480 - 535)	99 (14.360)	29 (4.200)	81 ±3	0,190	-35 to +180 (-31 to +356)	+125 °C (+257)	approx. +62 °C	+130 °C
WEICON GL-S	59 (8.560)	7.100 - 7.300 (1.030 - 1.060)	116 (16.800)	80 (11.600)	90 ±3	0,130	-35 to +180 (-31 to +356)	+55 °C (+131)	approx. +52 °C	+69 °C
WEICON Ceramic W	65 (9.430)	8.000 - 8.400 (1.160 - 1.220)	89 (12.900)	10 (1.450)	87 ±3	0,120	-35 to +200 briefly to +260* (-31 to +392 briefly to +500)	+150 °C* (+302)	approx. +60 °C	+144 °C*2
WEICON SF	37 (5.350)	3.500 - 4.500 (510 - 650)	52 (7.540)	41 (5.950)	82 ±3	0,820	-35 to +90 (-31 to +194)	+40 °C (104)	approx. +41 °C	-
WEICON ST	48 (6.960)	7.300 - 7.900 (1.060 - 1.150)	96 (13.900)	38 (5.500)	85 ±3	0,140	-35 to +120 (-31 to +248)	+50 °C (+122)	approx. +48 °C	+94 °C
WEICON HP	31 (4.500)	1.800 - 2.000 (260 - 290)	65 (9.430)	50 (7.250)	75 ±3	0,120	-35 to +160 (-31 to +320)	+65 °C (+149)	approx. +64 °C	+87 °C
WEICON TI	53 (7.690)	6.200 - 6.800 (900 - 990)	66 (9.570)	10 (1.450)	83 ±3	0,090	-35 to +200 briefly to +260* (-31 to +392 briefly to +500)	+150 °C* (+302)	approx. +52 °C	+148 °C*2
WEICON UW	31 (4.500)	1.800 - 2.000 (260 - 290)	65 (9.430)	50 (7.250)	75 ±3	0,120	-35 to +160 (-31 to +320)	+65 °C (+149)	approx. +64 °C	+87 °C
WEICON WP	23 (3.340)	2.500 - 2.900 (360 - 420)	51 (7.400)	35 (5.100)	75 ±3	0,110	-35 to +120 (-31 to +248)	+65 °C (+149)	approx. +64 °C	+87 °C
WEICON WR	46 (6.670)	4.900 - 5.300 (710 - 770)	100 (14.500)	85 (12.350)	83 ±3	0,060	-35 to +120 (-31 to +248)	+55 °C (+131)	approx. +54 °C	+70 °C
WEICON WR2	63 (9.140)	8.000 - 8.500 (1.160 - 1.230)	115 (16.680)	39 (5.660)	87 ±3	0,040	-35 to +120 (-31 to +248)	+55 °C (+131)	approx. +54 °C	+59 °C
WEICON Casting Resin MS 1000	56 (8.120)	2.500 - 2.600 (360 - 380)	92 (13.340)	90 (13.050)	81 ±3	0,010	-35 to +120 (-31 to +248)	+52 °C (+126)	approx. +43 °C	+62 °C
WEICON Casting Resin Plus 90	33 (4.800)	1.097 (150)	30 (4.300)	10 (1.450)	73 ±3	0,350	-35 to +120 (-31 to +248)	+41 °C (+105,8)	approx. +35 °C	+35 °C

* after tempering (for more information, see technical datasheet)
 *2 tempered at +150 °C

WEICON PLASTIC METAL CONSUMPTION

	WEICON A	WEICON B	WEICON BR	WEICON C	WEICON F	WEICON F2	WEICON HB 300	WEICON Ceramic BL	WEICON Ceramic HC 220	WEICON GL	WEICON GL-S	WEICON Ceramic W	WEICON SF	WEICON ST	WEICON HP	WEICON TI	WEICON UW	WEICON WP	WEICON WR	WEICON WR2	WEICON Epoxy Resin Putty	WEICON Casting Resin MS 1000	WEICON Casting Resin Plus 90	WEICON CBC
Consumption (Kilogram per m ²) 1,0 mm application thickness	3,40	2,50	1,80	1,60	1,40	1,60	2,50	1,80	1,70	1,30	1,80	1,60	1,80	1,70	1,50	1,60	1,50	2,20	2,40	1,70	2,00	1,20	1,10	1,50

WEICON CBC Chocking Backing Compound

Certified by ABS | vibration-resistant | impact-resistant

WEICON CBC is suitable for the shimming and backfilling of systems difficult to align in the industrial and maritime sector. The "ABS Product Design Assessment" certified system serves as a replacement for fittings and worn metal sheets, like steel or other materials, and ensures the direct contact to foundation plates.

The special epoxy resin system has a low viscosity, is very flowable and self-levelling. It has a pot life of 30 minutes and cures nearly shrink-free. It provides a permanent high-static stability and has a high resistance to ageing. The epoxy resin system adheres particularly well to steel and concrete. It has a good compressive strength and is resistant to oils, fuels and many chemicals. It is vibration-resistant as well as temperature-resistant.

Due to almost no cure shrinkage, machines and systems keep their specific alignment after the casting of WEICON CBC.

- ▶ 3,0 kg (2.0 l) ▶ 10,0 kg (6.6 l)
- 10110030 10110110**



WEICON®

European Exhibition Award
for creativity and innovation



Epoxy Resin Systems

WEICON CBC



Technical Data

Basis:	epoxy	
Filler:	aluminium	
Texture:	flowable	
Specific properties:	liquid, impact-resistant	
Mixing ratio by weight % (Resin/Hardener):	100 : 30	
Pot Life at +20°C, 10 kg preparation:	30 min.	
Density of the mixture:	1,5 g/cm ³	
Viscosity of the mixture at +25°C:	45.000 mPa.s	
Processing temperature:	+15°C to +40°C	
Can be exposed to mechanical stresses (80% strength) after:	10 h	
Final strength (100% strength) after:	24 h	
Mean compressive strength (DIN EN ISO 604):	70 MPa	
Strength-E-Module (DIN EN ISO 527):	3800-4500 MPa	
Elongation at break (DIN EN ISO 527):	1,8 %	
Impact strength (ISO 179-1/1eU):	3,7 kJ/m ²	
Shore D (DIN ISO 7619):	80 Shore D	
Shrinkage:	0,06 %	
Colour after curing:	grey	
Temperature resistance:	-40°C to +160°C	
Glass transition temperature	T _g after curing at room temperature	approx. +52 °C
	T _g after tempering at 120 °C	+77 °C

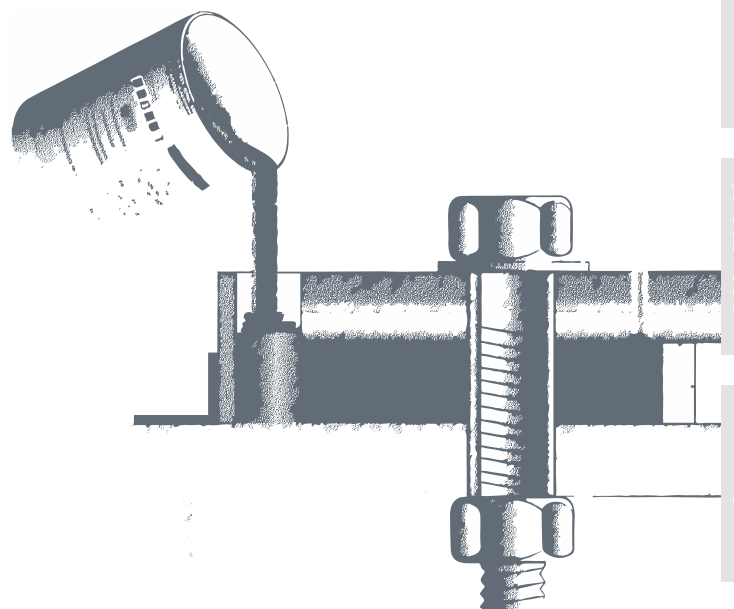

Adhesives / Sealants

Technical Sprays

Technical Liquids

Assembly Pastes

Lubricants

WEICON TOOLS®

Other



Applications

- ▶ pipe repairs
- ▶ structural reinforcement
- ▶ repairs in spaces difficult to access

VIDEO



WEICON Pipe Repair-Kit

The set is designed for the emergency repair of defective and damaged pipes and pipelines. It comprises one WEICON Repair Stick Steel, a special repair tape made of fibreglass-reinforced plastic, assembly instructions and a pair of protective gloves. The repair tape is impregnated with a special resin and activated by contact with water.

The Pipe Repair-Kit can be processed without any additional tools and is used for the reliable and permanent sealing of cracks and leaks. It is very easy and quick to use and shows excellent adhesive properties, high pressure and chemical resistance as well as temperature resistance up to 150°C.

The Repair-Kit can be used in various areas of industry for the quick and easy repair of chemical, steam, process and water pipes.

Within 30 minutes, the tape is fully cured and hard-wearing. Due to the fabric properties of the tape, the resulting high flexibility and the simple processing, the repair kit is particularly suitable for sealing leaks in bends, T-pieces or in spaces difficult to access.

It can be used on many different surfaces such as stainless steel, aluminium, copper, PVC, many plastics, fibreglass, concrete, ceramics and rubber.

5/15 ▶ 5 cm x 1,5 m 10710001	5/35 ▶ 5 cm x 3,5 m 10710002	10/35 ▶ 10 cm x 3,5 m 10710003	12/100 ▶ 12 cm x 10 m 10710004
---	---	---	---

The set includes

- Repair Stick Steel
- fibreglass-reinforced plastic repair tape
- assembly instructions
- protective gloves



Adhesives / Sealants

Technical Sprays

Technical Liquids

Assembly Pastes

Lubricants

WEICON TOOLS®

Other



Pipe / Belt Repair-Kit



VIDEO



WEICON Belt Repair-Kit

WEICON Belt Repair-Kit is a 2-component polyurethane system for the fast repair and coating of rubber surfaces.

It has a high curing speed, high elasticity and wear resistance, is impact-resistant and abrasion-resistant, and has a particularly high tear resistance.

Thanks to its high mechanical strength, it is suitable especially for repairs on rubber and metal components, which are exposed to impacts, abrasion or vibrations.

The Belt Repair-Kit offers fast and easy processability. After just 30 minutes, the treated surface can already be sanded and smoothed. The system is suitable for various applications, such as the repair and coating of conveyor belts, the repair of rubber coatings, for use as flexible wear protection, and for the fast repair of worn-out rubber surfaces.

In addition to the polyurethane system, the set comprises a primer for surface pre-treatment, and a spatula to spread the compound evenly.

In order to cover a broader application range, in addition to the classic 500 g working package, which needs to be mixed by hand, the product is also available as easy-to-use 540 g double cartridge.

Belt Repair-Kit 550
 ▶ 500 g + Primer G 50 g
 10851005

Belt Repair-Kit 590
 ▶ 540 g + Primer G 50 g
 10851015

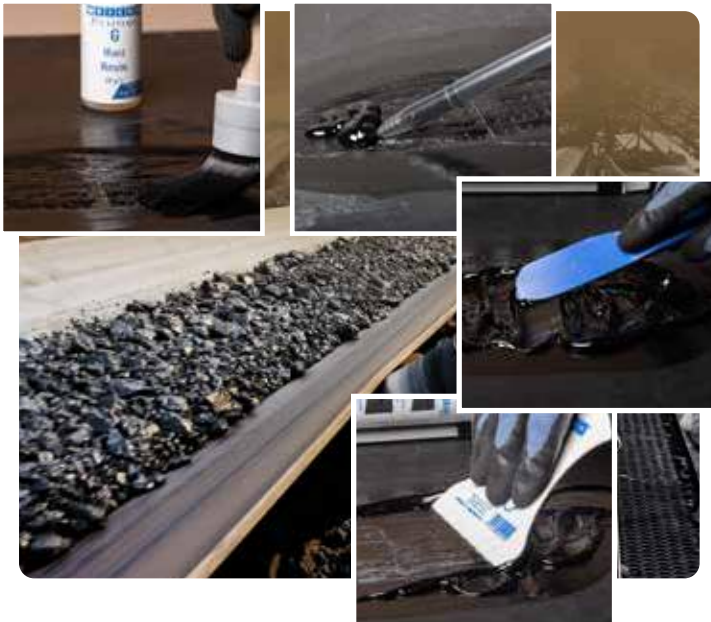

Dispenser 2C 10:1

Recommended for the 2-component 540g cartridge.

10653491

Mixing Nozzle MFHX

Suitable for Urethane 85 (540g cartridge)

10650027

Primer G

Special bonding agent for urethanes for the pre-treatment of rubber and metal surfaces.

10809050



Marine Emergency Repair Kits

For emergency repairs and maintenance works on board of ships, we developed three different Repair Kits. WEICON Marine Emergency Repair Kits are equipped with many different products that support you in various cases. The kits cover most cases of offshore emergency repairs and maintenance works during long passages. The Repair Kits differ in the range of included products. Repair Kit 1 covers the most common emergency and maintenance cases. Kit 3 covers many different applications on board. The Repair Kits are suitable for all ships, where repairs and maintenance have to be carried out frequently.



As a service for our customers, WEICON provides the Marine Emergency Repair Kits with all necessary dangerous goods declarations.



+ incl. transport documents (ATA, IMO, ADR)

Kit 2

- ▶ WEICON ▶ IMPA ▶ ISSA
- 10851002 81 29 08 84.025.02

		WEICON	IMPA	ISSA	Quantity						
WEICON A	▶ 0,5 kg	10000005	81 29 01	75.509.01	2	•					•
WEICON HB 300	▶ 1,0 kg	10450010	81 29 51	75.509.21	1						•
WEICON SF	▶ 0,5 kg	10250005	81 29 31	75.509.13	2	•					•
WEICON UW	▶ 0,5 kg	10440005	81 29 35	75.509.24	2						
Repair Stick Aqua	▶ 115 g	10531115	81 29 24	75.530.03	3						•
Repair Stick Steel	▶ 115 g	10533115	81 29 26	75.530.01	3						•
Pipe Repair-Kit 5/15	▶ ---	10710001	---	84.025.17	2						•
AN 302-43	▶ 50 ml	30243150	81 29 13	75.628.04	1		•	•			
AN 302-60	▶ 50 ml	30260150	81 52 05	75.628.32	1						
VA 8312	▶ 30 g	12200030	81 52 42	75.629.05	1					•	
VM 120	▶ 30 g	12350030	---	---	1						
GMK 2410	▶ 700 g	16100700	81 52 38	84.025.09	1						
Black-Seal	▶ 200 ml	13051200	81 52 85	75.634.25	1						
Cleaner Spray S	▶ 500 ml	11202500	45 08 01	53.402.01	2						
W 44 T	▶ 400 ml	11251400	45 08 21	53.402.11	1						
Rust Shock	▶ 400 ml	11151400	45 08 22	53.402.10	1						
Starter Spray	▶ 400 ml	11660400	---	---	1						
Contact Spray	▶ 400 ml	11152400	45 08 43	53.402.28	1						
Processing Kit	▶ ---	10851010	81 29 88	---	1						
Repair-Tape 5/35	▶ ---	10710536-L	---	---	1						
Repair-Tape 10/35	▶ ---	10711036-L	---	---	1						

Adhesives / Sealants

Technical Sprays

Technical Liquids

Assembly Pastes

Lubricants

WEICON TOOLS®

Other

Emergency Repair Kits

Kit 1

▶ WEICON ▶ IMPA ▶ ISSA
 10851001 81 29 07 84.025.01

		WEICON	IMPA	ISSA	Quantity		
WEICON A	▶ 0,5 kg	10000005	81 29 01	75.509.01	2	•	•
WEICON SF	▶ 0,5 kg	10250005	81 29 31	75.509.13	2	•	•
WEICON UW	▶ 0,5 kg	10440005	81 29 35	75.509.24	2		
Repair Stick Aqua	▶ 115 g	10531115	81 29 24	75.530.03	2		•
Repair Stick Steel	▶ 115 g	10533115	81 29 26	75.530.01	2	•	•
Pipe Repair-Kit 5/15	▶ ---	10710001	---	84.025.17	1	•	
Processing Kit	▶ ---	10851010	81 29 88	---	1		
Repair-Tape 5/35	▶ ---	10710536-L	---	---	1		
Repair-Tape 10/35	▶ ---	10711036-L	---	---	1		

Processing Kit

▶ WEICON ▶ IMPA
 10851010 81 29 88



Glass Fibre Cloth Tape, Processing Spatula, Processing Can, Gloves, Wire Mesh, Butyl Tape, Brush, Cutter

Kit 3

▶ WEICON ▶ IMPA ▶ ISSA
 10851003 81 29 09 84.025.03

		WEICON	IMPA	ISSA	Quantity						
WEICON A	▶ 0,5 kg	10000005	81 29 01	75.509.01	2	•					•
WEICON BR	▶ 0,5 kg	10420005	81 29 10	75.509.05	1						•
WEICON HB 300	▶ 1,0 kg	10450010	81 29 51	75.509.21	1						•
WEICON Ceramic BL	▶ 0,5 kg	10400005	81 29 37	75.509.19	1	•					•
WEICON SF	▶ 0,5 kg	10250005	81 29 31	75.509.13	2	•					•
WEICON UW	▶ 0,5 kg	10440005	81 29 35	75.509.24	2						•
WEICON WR	▶ 0,5 kg	10300005	81 29 47	75.509.15	1						•
Repair Stick Aqua	▶ 115 g	10531115	81 29 24	75.530.03	4						•
Repair Stick Steel	▶ 115 g	10533115	81 29 26	75.530.01	4						•
Pipe Repair-Kit 5/15	▶ ---	10710001	---	84.025.17	3						•
Urethane 80	▶ 0,5 kg	10518005	81 29 63	75.509.42	1						•
AN 302-43	▶ 50 ml	30243150	81 29 13	75.628.04	1	•	•				
AN 302-60	▶ 50 ml	30260150	81 52 05	75.628.32	1						
AN 305-77	▶ 50 ml	30577150	81 52 14	75.628.13	1	•	•	•	•	•	•*
AN 306-38	▶ 50 ml	30638150	81 52 23	75.628.19	1	•					
Thread Sealing Cord DF 175	▶ ---	30010175	---	75.628.40	1		•			•	•
Plast-o-Seal	▶ 90 g	30000090	81 52 31	75.628.41	1						•
VA 8312	▶ 30 g	12200030	81 52 42	75.629.05	1		•				
VM 120	▶ 30 g	12350030	---	---	1						
GMK 2410	▶ 700 g	16100700	81 52 38	84.025.09	1						
Black-Seal	▶ 200 ml	13051200	81 52 85	75.634.25	1						
Cleaner Spray S	▶ 500 ml	11202500	45 08 01	53.402.01	2						
Sealant and Adhesive Remover	▶ 400 ml	11202400	45 08 02	53.402.02	1						
W 44 T®	▶ 400 ml	11251400	45 08 21	53.402.11	1						
Rust-Shock	▶ 400 ml	11151400	45 08 22	53.402.10	1						
Mould Release Agent	▶ 400 ml	11450400	---	---	1						
Starter Spray	▶ 400 ml	11660400	---	---	1						
Contact Spray	▶ 400 ml	11152400	45 08 43	53.402.28	1						
AS 500	▶ 500 g	26000050	45 08 46	---	1						
Processing Kit	▶ ---	10851010	81 29 88	---	1						
Repair-Tape 5/35	▶ ---	10710536-L	---	---	1						
Repair-Tape 10/35	▶ ---	10711036-L	---	---	1						

*BAM tested and safety-related evaluated- see also leaflet M 034e "Oxygen" (DGV information 213-074) of BG RCI.



The easy solution for all repair and maintenance work.

Adhesives / Sealants

Technical Sprays

Technical Liquids

Assembly Pastes

Lubricants

WEICON TOOLS®

Other

Cut

Knead

Use

- ▶ even for small repairs
- ▶ the cured product can be machined (drilled, filed, tapped)

Repair Stick Steel



Fast cure | steel-filled | drinking water approval

It is particularly suited for the fast and high strength repair and bonding of metal parts and for the patching and sealing of cracks, holes, and leaks in machine parts, tanks and pipelines, containers, pumps and housings, balcony railings, banisters, and torn-out threads. The WEICON Repair Stick Steel can be used in machine and system construction, in tank construction and apparatus engineering, in the foods, cosmetic and pharmaceutical industries and many other applications.

- ▶ 57 g
10533057
- ▶ 115 g
10533115

Repair Stick Aqua

For underwater applications | ceramic-filled

Ideal for quick repairs on damp and wet surfaces and for underwater applications.

For the repair and sealing of cracks, holes, and leaks in petrol and water tanks, radiators, electrical switchboards, sanitary installations and swimming pools. The WEICON Repair Stick Aqua can be used in sanitary and heating system construction, electrical equipment, the maritime sector and many additional industrial applications.

- ▶ 57 g
10531057
- ▶ 115 g
10531115



Epoxy Resin Systems

Repair Sticks

Repair Stick Titanium

Wear-resistant | titanium-filled | high-temperature-resistant up to +280°C (+536°F) (briefly up to +300°C/+572°F)

It is suited for the permanent and wear-resistant repair and bonding of metal parts such as tanks and pipelines, aluminium, light metal and injection moulded parts, shafts and slide bearings, pumps and housings and torn-out threads.

The WEICON Repair Stick Titanium can be used in machine and system construction, tank construction and apparatus engineering, and many other industrial applications.

► 57 g ► 115 g
10535057 10535115



Repair Stick Stainless Steel



Non-corrosive | fast-curing | stainless steel-filled | drinking water approval

For non-corrosive repair and reconditioning of stainless steel and other rustproof metals, such as those in tanks and containers, filling and packing machines, pipes, lines, pumps and housings.

Due to the quick mechanical loading capacity of the mended parts (approx. 60 minutes), expensive and longer downtimes are avoided. The WEICON Repair Stick Stainless Steel can be used in tank construction and apparatus engineering, in the foods, cosmetic and pharmaceutical industries and many other applications.

► 57 g ► 115 g
10538057 10538115



Repair of a pump
Repair Stick Steel

Pipe sealing on a water tank
Repair Stick Multi-Purpose

Repair Stick Wood

Residual elasticity | mineral-filled

For permanent repairs of wooden parts with residual elasticity and without shrinkage. For the repair of cracks and bore holes, broken out or broken off wooden parts and for the sealing of joints on windows and door frames, veneers, boards and planks, models and wooden toys.

WEICON Repair Stick Wood can be used in the wood and furniture industry, in model building and many other applications.

- ▶ 28 g ▶ 56 g
- 10532057 10532115



WEICON Repair Stick Wood

A special item in the product range is the Repair Stick Wood. It was developed for carrying out repairs on furniture, shelving, etc. To enable a "seamless" repair, it has the same density as wood.

After curing, it can be processed like wood, e.g. sanded and painted. In the test shown below, the WEICON Repair Stick floats on the surface like wood, while competitive products sink to the bottom due to their high density.



Repair Stick Plastic

Plastic-filled | drinking water approval



Especially for the permanent repair of plastic components and composite materials with residual elasticity such as window and door frames, panelling and bumper bars.

For the bonding of metal parts such as pipes and pipe bends, fittings and flanges, water tanks, pumps and housings.

- ▶ 57 g ▶ 115 g
- 10536057 10536115

Repair Stick Multi-Purpose



Fast-curing | mineral-filled | drinking water approval

The all-round product for quick, elastic and non-shrink repairs and touch-ups on nearly all surfaces. Repair Stick Multi fills and seals cracks, holes, damages and leaks. It can be used on metal, wood, stone, ceramics, plastic and many other materials.

Due to its versatile use, WEICON Repair Stick Multi is suitable for industrial applications as well as for skilled trades or DIY projects.

- ▶ 57 g ▶ 115 g
- 10539057 10539115



Sealing of a copper tube
Repair Stick Copper



Adhesives / Sealants
Technical Sprays
Technical Liquids
Assembly Pastes
Lubricants
WEICON TOOLS®
Other

Repair Sticks

Repair Stick Copper



Extremely fast-curing | copper-filled | drinking water approval

The WEICON Repair Stick Copper is suited for the very quick repair (processing time: 3 min.) of cracks and leaks even on damp and wet surfaces such as pipes, pipe bends, fittings, flanges, copper gutters, sheets, water heaters, water tanks, hot, cold water lines, freezer and air conditioning systems.

The WEICON Repair Stick Copper can be used in tank construction and apparatus engineering, in the foods, cosmetic and pharmaceutical industries and many other applications.

- ▶ 57 g ▶ 115 g
- 10530057 10530115

Repair Stick Concrete

Fast-curing | ceramic-filled

Especially for quick repair and reconditioning of all concrete, stone and ceramic surfaces.

Fills and seals cracks and defects on masonry, stone, concrete and ceramic tiles and on bricks, borders, kerbstones, statues, tombstones and ornaments. It can also be used for the reinforcement of pegs, screws and anchors in outdoor and indoor areas. The WEICON Repair Stick Concrete can be used in the construction industry, in gardening and landscaping, and many other applications.

- ▶ 57 g ▶ 115 g
- 10537057 10537115

Repair Stick Aluminium

Non-rusting | fast-curing | aluminium-filled

For the quick and non-rusting repair and bonding of metal parts. For the repair of cracks, holes and leaks in car bodies, gearboxes and tanks, window frames and profiles, and boats and models.

The WEICON Repair Stick Aluminium can be used in machine and system construction, in the automotive industry, in gear construction, window construction, model building and many other applications.

- ▶ 57 g ▶ 115 g
- 10534057 10534115

Type selection table

	Aluminium	Aqua	Concrete	Stainless Steel	Wood	Plastic	Copper	Steel	Titanium	Multi-Purpose
Metals (e.g. aluminium, cast iron, brass, stainless steel)	++	++	+	++	+	+	++	++	++	++
Hard plastics* (e.g. epoxy resin, rigid PVC)	+	++	+	+	+	++	+	+	+	++
Fibre-reinforced materials (e.g. GFRP, CFRP, fibreglass)	+	+	+	+	+	++	+	+	+	+
Wood (e.g. oak, beech, spruce, balsa)	+	+	+	+	++	+	+	+	+	+
Derived timber products (e.g. plywood, MDF)	+	+	+	+	++	+	+	+	+	+
Glass, ceramics	+	++	+	+	+	+	+	+	+	++
Stone (e.g. marble, granite, brick, concrete)	+	++	++	+	+	+	+	+	+	++
Rubber / elastomers	-	-	-	-	-	-	-	-	-	-

Highly suitable (++)

Suitable (+)

Not suitable (-)

*Except for plastics such as polyethylene, polypropylene, polyacetal, polytetrafluoroethylene and other fluorinated hydrocarbons with naturally adhesive-rejecting surfaces. When following the recommendations above, bonding of dissimilar material pairs such as metals and plastics is also possible.





Technical Data

		WEICON Repair-Sticks in non-cured condition									
		Aluminium	Aqua	Concrete	Stainless steel	Wood	Plastic	Copper	Steel	Titanium	Multi-Purpose
NSF <small>Certified to NSF/ANSI 61</small>					✓		✓	✓	✓		✓
Basis:		Epoxy resin aluminium fillers	Epoxy resin ceramic fillers	Epoxy resin ceramic fillers	Epoxy resin stainless steel fillers	Epoxy resin mineral fillers	Epoxy resin plastic fillers	Epoxy resin copper fillers	Epoxy resin metal fillers	Epoxy resin titanium fillers	Epoxy resin mineral fillers
Consistency:		modelling compound	modelling compound	modelling compound	modelling compound	modelling compound	modelling compound	modelling compound	modelling compound	modelling compound	modelling compound
Supplied in:		Stick	Stick	Stick	Stick	Stick	Stick	Stick	Stick	Stick	Stick
Contents:		57 g / 115 g	57 g / 115 g	57 g / 115 g	57 g / 115 g	28 g / 56 g	57 g / 115 g	57 g / 115 g	57 g / 115 g	57 g / 115 g	57 g / 115 g
Mixing proportion by volume resin / hardener (automatically):		1 : 1	1 : 1	1 : 1	1 : 1	1 : 1	1 : 1	1 : 1	1 : 1	1 : 1	1 : 1
Pot life with 10 g material and at +20°C (+68°F) (in minutes):		6	25	5	5	15	15	3-4	5	30	4
Density of the mixture (g/cm ³):		1,9	1,9	1,9	2,2	0,9	1,6	1,9	2,2	1,9	1,9
Temperature °C (°F)	Processing: ^{*1}	+15 to +40 (+59 to +104)	+15 to +40 (+59 to +104)	+15 to +40 (+59 to +104)	+15 to +40 (+59 to +104)	+15 to +40 (+59 to +104)	+15 to +40 (+59 to +104)	+15 to +40 (+59 to +104)	+15 to +40 (+59 to +104)	+15 to +40 (+59 to +104)	+15 to +40 (+59 to +104)
	Curing:	+6 to +40 (+43 to +104)	+6 to +40 (+43 to +104)	+6 to +40 (+43 to +104)	+6 to +40 (+43 to +104)	+6 to +40 (+43 to +104)	+6 to +40 (+43 to +104)	+6 to +40 (+43 to +104)	+6 to +40 (+43 to +104)	+6 to +65 (+43 to +149)	+6 to +40 (+43 to +104)
Colour after curing:		aluminium-grey	white	concrete-grey	dark-grey	beige	white-blue	copper	dark-grey	brown	white
Gap covering power to max.: ^{*2}		15 mm	15 mm	15 mm	15 mm	15 mm	15 mm	15 mm	15 mm	15 mm	15 mm
Curing time at +20°C (+68°F)	Handling strength (35% strength) after:	10 min.	30 min.	15 min.	10 min.	45 min.	40 min.	10 min.	10 min.	1 h	15 min.
	Capable of bearing mechanical loads (80% strength) after:	60 min.	60 min.	60 min.	60 min.	60 min.	3 h	60 min.	60 min.	4 h	60 min.
	Final strength (100% strength) after:	24 h	24 h	24 h	24 h	24 h	24 h	24 h	24 h	48 h (24 h at +65°C/+149°F)	24 h

		WEICON Repair Sticks in cured condition									
Pressure (DIN EN ISO 604) MPa (psi):		55 (7.980)	55 (7.980)	55 (7.980)	55 (7.980)	55 (7.980)	55 (7.980)	55 (7.980)	55 (7.980)	80 (11.600)	55 (7.980)
Shore hardness D:		80±3	70±3	80±3	80±3	70±3	65±3	82±3	80±3	80±3	80±3
Average tensile shear strength after 7 days at +20°C (+68°F) in accordance with DIN EN 1465 MPa (psi):		Aluminium sandblasted 4,2 (609)	Steel sandblasted 6,2 (899)	Concrete 4,8 (696)	Stainless steel sandblasted 3,9 (566)	Beech sanded 6,2 (899)	PVC sanded 2,4 (348)	Copper sandblasted 4,8 (696)	Steel sandblasted 4,1 (595)	Steel sandblasted 7,5 (1.080)	Steel sandblasted 6,5 (943)
Temperature resistance °C (°F):		-50 to +120, briefly +150 (-58 to +248, briefly +302)	-50 to +120, briefly +150 (-58 to +248, briefly +302)	-50 to +120, briefly +150 (-58 to +248, briefly +302)	-50 to +120, briefly +150 (-58 to +248, briefly +302)	-50 to +120, briefly +150 (-58 to +248, briefly +302)	-50 to +120, briefly +150 (-58 to +248, briefly +302)	-50 to +120, briefly +150 (-58 to +248, briefly +302)	-50 to +120, briefly +150 (-58 to +248, briefly +302)	-50 to +230, briefly to +260 (-58 to +446, briefly to +500)	-50 to +120, briefly to +150 (-58 to +248, briefly to +302)
Thermal conductivity (DIN EN ISO 22007-4):		0,65 W/m·K	0,50 W/m·K	0,50 W/m·K	0,60 W/m·K	0,30 W/m·K	0,40 W/m·K	0,70 W/m·K	0,60 W/m·K	0,50 W/m·K	0,40 W/m·K
Linear shrinkage:		< 1%	< 1%	< 1%	< 1%	< 1%	< 1%	< 1%	< 1%	< 1%	< 1%
Electrical resistance (DIN IEC93)		5 · 10 ¹¹ Ω·cm	5 · 10 ¹¹ Ω·cm	5 · 10 ¹¹ Ω·cm	5 · 10 ¹¹ Ω·cm	5 · 10 ¹¹ Ω·cm	5 · 10 ¹¹ Ω·cm	5 · 10 ¹¹ Ω·cm	5 · 10 ¹¹ Ω·cm	5 · 10 ¹¹ Ω·cm	5 · 10 ¹¹ Ω·cm
Dielectric strength (ASTM D 149):		3,0 kV/mm	3,0 kV/mm	3,0 kV/mm	3,0 kV/mm	3,0 kV/mm	3,0 kV/mm	3,0 kV/mm	3,0 kV/mm	3,0 kV/mm	3,0 kV/mm
Thermal expansion coefficient (ISO 11359):		30-40 · 10 ⁻⁶ 1/m·K	30-40 · 10 ⁻⁶ 1/m·K	30-40 · 10 ⁻⁶ 1/m·K	30-40 · 10 ⁻⁶ 1/m·K	30-40 · 10 ⁻⁶ 1/m·K	30-40 · 10 ⁻⁶ 1/m·K	30-40 · 10 ⁻⁶ 1/m·K	30-40 · 10 ⁻⁶ 1/m·K	30-40 · 10 ⁻⁶ 1/m·K	30-40 · 10 ⁻⁶ 1/m·K

*1 For easier workability when ambient temperatures are low, the sticks should be warmed up to room temperature (20°C/+68°F) before application.
*2 Max. 15 mm per procedure

Test Results

We have conducted a series of laboratory tests to compare sticks from various countries. Some of the test results are summarised in the tables shown below.

Adhesive strength of Repair Stick Aqua

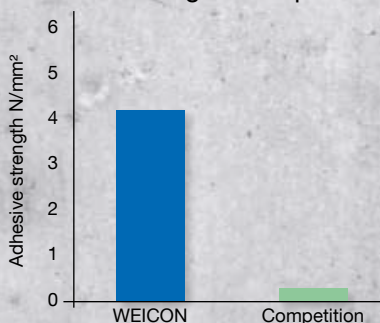

Shore hardness D Repair Stick Plastic after completely hardening

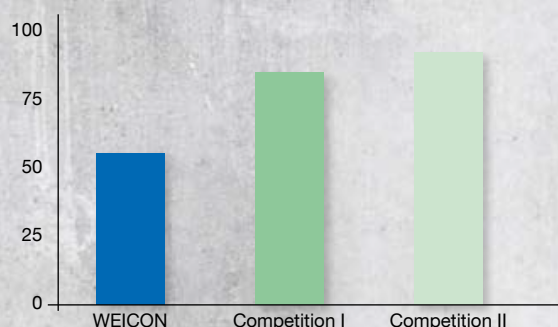

Repair-Tape

Repair-Tapes

Flexible, durable and **self-fusing** repair tape made of fibreglass-reinforced plastic for fast emergency repairs in indoor or outdoor areas. The Repair-Tape is soaked with a special resin and is activated by contact with water.

It enables a very easy and fast application as well as very high adhesive strength on nearly all surfaces. After just 30 minutes, the tape is fully cured and hard-wearing. After curing, the tape can be sanded and painted.

The tape can be applied without additional tools and is used for reliable and durable repairs in industrial applications, skilled trades, around the house, and in the camping and DIY sector.



▶ 5 cm x 1,5 m
10710515

▶ 5 cm x 3,5 m
10710536

▶ 10 cm x 3,5 m
10711036

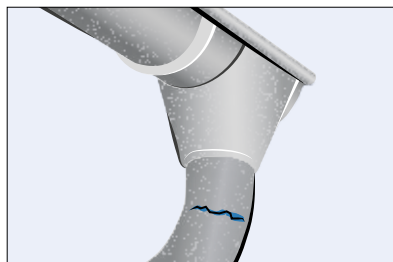
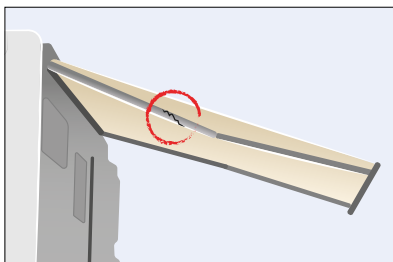
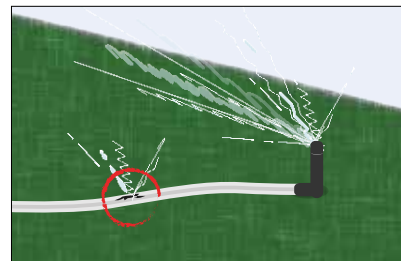
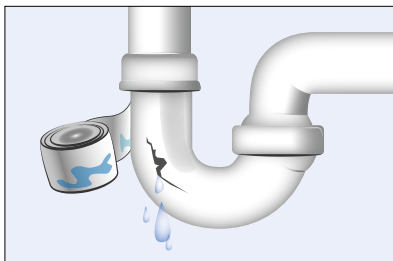

Tensile shear strength on steel

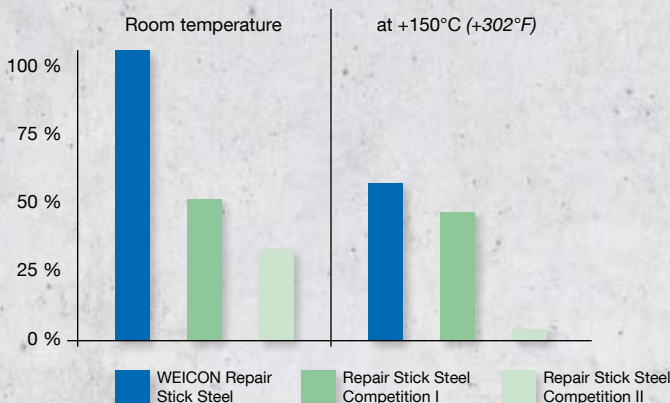

Adhesive strength of Repair Stick Steel

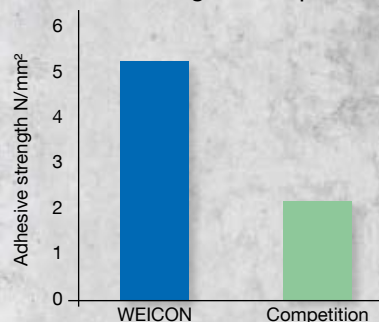

WEICON Epoxy Adhesives are cold-curing, solvent-free two-component systems with extremely strong bonding properties. They enable material bonds with high tensile and impact strength and are thus ideal for assembly, repairs and production.

In particular in cases of innovative constructions and bonds between different materials such as

- ▶ metals
- ▶ hard plastics
- ▶ fibre-reinforced materials (GFK, CFK, fibreglass etc.)
- ▶ ceramics
- ▶ glass, stone
- ▶ wood etc.

Today's requirements are ever more demanding (e.g. visually appealing joints along with very high strength). These materials are also often combined with each other, which leads to additional demands.

Epoxy casting compound for **electronic components**

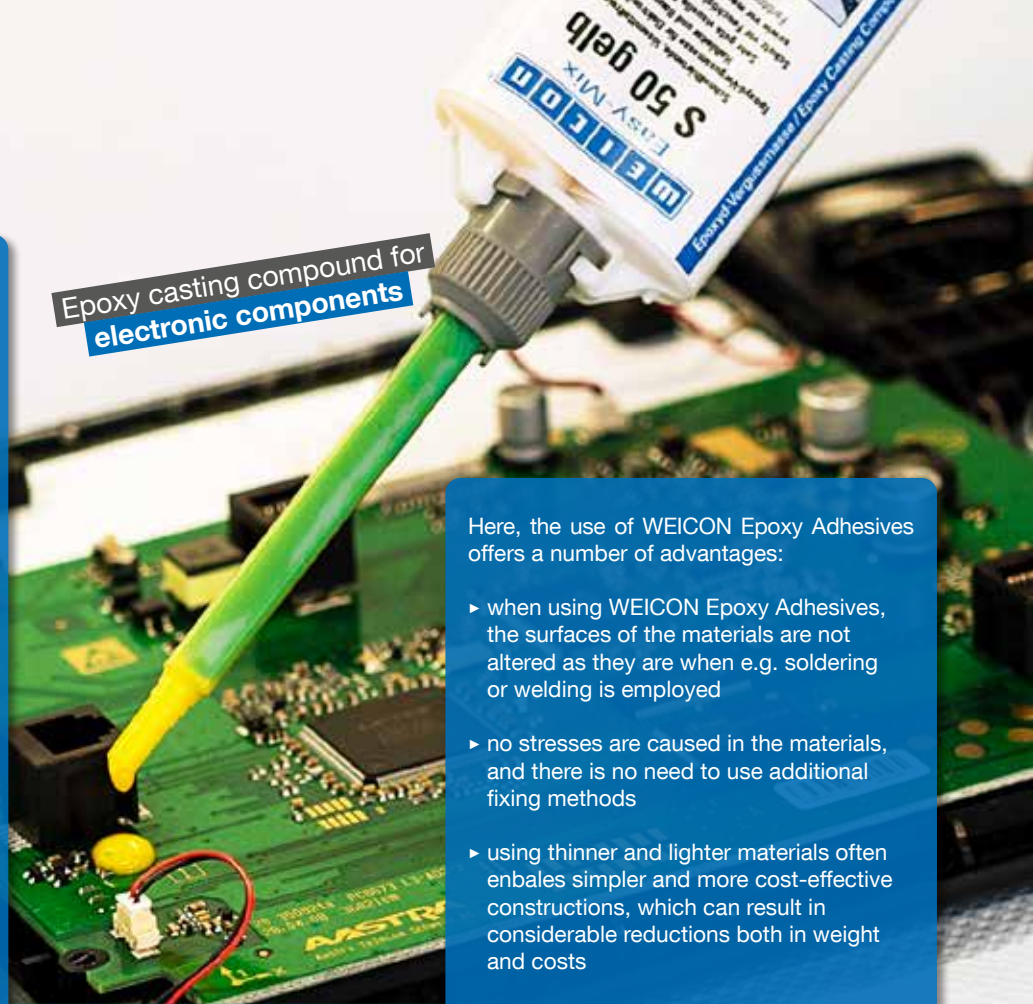

Here, the use of WEICON Epoxy Adhesives offers a number of advantages:

- ▶ when using WEICON Epoxy Adhesives, the surfaces of the materials are not altered as they are when e.g. soldering or welding is employed
- ▶ no stresses are caused in the materials, and there is no need to use additional fixing methods
- ▶ using thinner and lighter materials often enables simpler and more cost-effective constructions, which can result in considerable reductions both in weight and costs



Epoxy Minute Adhesive

Viscous | self-levelling | fast-curing | very short pot life | transparent

▶ 24 ml
10550024

Can alternatively be processed with Quadro Mixing Nozzle (Art.-Nr. 10650005)



Fast-Metal Minute Adhesive

Highly filled | pasty | gap-filling | very short pot life | fast-curing

▶ 24 ml
10551024



Aluminium Minute Adhesive

Aluminium-filled | gap-filling | fast-curing | high peel and impact strength

▶ 24 ml
10552024

Epoxy Minute Adhesive Set NEW

Comprising: Epoxy Minute Adhesive, Wooden Spatula small, Mixing Nozzle Quadro, PE gloves

▶ Set
10550025

Fast-Metal Minute Adhesive Set NEW

Comprising: Fast-Metal Minute Adhesive, 2 x Wooden Spatula small, PE gloves

▶ Set
10551025

Aluminium Minute Adhesive Set NEW

Comprising: Aluminium Minute Adhesive, Wooden Spatula small, Mixing Nozzle Quadro, PE gloves

▶ Set
10552025



Adhesives / Sealants
Technical Sprays
Technical Liquids
Assembly Pastes
Lubricants
WEICON TOOLS®
Other

Epoxy Adhesives

WEICON Easy-Mix Mixing and Dosing System

Thanks to the modern mixing and dosing system, all types can be cleanly and accurately dosed, mixed and applied automatically in just one step.

That way, a uniform quality and process safety is guaranteed in a production series. Product advantages:

- ▶ ready for use
- ▶ dosing, mixing and application in just one working step
- ▶ tedious mixing by hand is no longer necessary, so no mixing and dosing mistakes are possible
- ▶ speedy in application
- ▶ faster cycle times in series production possible
- ▶ economical in use, as minimal material wastage



Hand Dispenser D50

Robust, fracture-resistant construction of fibreglass-reinforced plastic (polyamide) with a metal trigger.

10653050

Quadro Mixing Nozzle

For all Easy-Mix types (except „Metal“, HT 180 and HT 250)

10650005

Helix Mixing Nozzle

For Easy-Mix Metal, HT 180 and HT 250

10650006

Easy-Mix S 50

Viscous | self-levelling | fast-curing | very short pot life | extremely high adhesive strength

- ▶ 50 ml
- 10650050

Easy-Mix S 50 yellow

Visual casting compound | solvent-free | fast-curing | shock-resistant | impact-resistant | high adhesive strength

- ▶ 50 ml
- 10651050



Easy-Mix HT 250 **NEW**

UL-TESTED

Very high temperature resistance up to +200 °C (+392 °F), briefly up to +250 °C (+482 °F) | high adhesion to metals | high thermal conductivity and high resistance to aggressive media and powder coatings

- ▶ 50 ml
- 10650855

Easy-Mix N 50

High adhesive strength | highly viscous | self-levelling | long pot life

- ▶ 50 ml
- 10650150

Easy-Mix N 5000

Almost colourless/transparent | liquid | self-levelling | short pot life

- ▶ 50 ml
- 10650250

The ideal adhesives for **POWDERCOATING**
HT 180 and HT 250

Easy-Mix HT 180

UL-TESTED

High temperature resistance | steady | shock- and impact resistant

- ▶ 50 ml
- 10650850

Easy-Mix Metal

UL-TESTED

Ideal for bonding metal parts | highly viscous | fast-curing

- ▶ 50 ml
- 10652050



Technical Data

WEICON Epoxy Adhesives in liquid condition											
	Easy-Mix S 50	Easy-Mix S 50 yellow	Easy-Mix N 50	Easy-Mix N 5000	Easy-Mix Metal	Easy-Mix HT 180	Easy-Mix HT 250	Epoxy Minute Adhesive	Aluminium Minute Adhesive	Fast Metal Minute Adhesive	
Basis:	Epoxy resin unfilled	Epoxy resin unfilled	Epoxy resin unfilled	Epoxy resin unfilled	Epoxy resin	Epoxy resin mineral-filled	Epoxy resin	Epoxy resin unfilled	Epoxy resin aluminium-filled	Epoxy resin high-filled	
Consistency:	viscous	viscous	viscous	fluid	viscous	pasty, gap-filling	viscous	viscous	pasty, gap-filling	crack-filler	
Supplied in:	double cartridge	double cartridge	double cartridge	double cartridge	double cartridge	double cartridge	double cartridge	double syringe	double syringe	double syringe	
Content:	50 ml	50 ml	50 ml	50 ml	50 ml	50 ml	50 ml	24 ml	24 ml	24 ml	
Mixing proportion by volume resin / hardener (automatically):	1 : 1	1 : 1	1 : 1	1 : 1	1 : 1	2 : 1	2 : 1	1 : 1	1 : 1	1 : 1	
Pot life with 10 ml material at +20°C (+68°F)	4 - 5	4 - 5	45	20	4 - 5	60	150	3 - 4	4 - 5	3 - 4	
Density of the mixture (g/cm ³):	1,15	1,20	1,07	1,07	1,80	1,10	2,10	1,15	1,23	1,80	
Viscosity of the mixture at +20°C (+68°F):	8.500 mPa's (cP)	8.500 mPa's (cP)	7.500 mPa's (cP)	5.000 mPa's (cP)	300.000 mPa's (cP)	pasty	38.000 mPa's (cP)	8.500 mPa's (cP)	125.000 mPa's (cP)	300.000 mPa's (cP)	
Temperature	Processing*1:	+10°C to +30°C (+50°F to +86°F)	+10°C to +30°C (+50°F to +86°F)	+10°C to +40°C (+50°F to +104°F)	+10°C to +35°C (+50°F to +95°F)	+10°C to +30°C (+50°F to +86°F)	+10°C to +40°C (+50°F to +104°F)	+10°C to +40°C (+50°F to +104°F)	+10°C to +30°C (+50°F to +86°F)	+10°C to +30°C (+50°F to +86°F)	
	Cure:	+6°C to +40°C (+43°F to +104°F)	+6°C to +40°C (+43°F to +104°F)	+10°C to +40°C (+50°F to +104°F)	+6°C to +40°C (+43°F to +104°F)	+6°C to +40°C (+43°F to +104°F)	+10°C to +50°C (+50°F to +122°F)	+10°C to +50°C (+50°F to +122°F)	+6°C to +40°C (+43°F to +104°F)	+6°C to +40°C (+43°F to +104°F)	
Colour:	transparent	yellow	slightly yellowish, clear	almost colourless, glass clear	grey	black	grey	transparent	aluminium	grey	
Gap covering power to max.*2:	2 mm	2 mm	2 mm	2 mm	4 mm	4 mm	4 mm	2 mm	4 mm	4 mm	
Cure time at +20°C (+68°F)	Handling strength (35%) after:	30 minutes	30 minutes	120 minutes	60 minutes	40 minutes	120 minutes	8 hours	30 minutes	25 minutes	40 minutes
	Capable of bearing mechanical loads (50% strength) after:	1 hour	1 hour	24 hours	3 hours	2 hours	4 hours	14 hours	1 hour	2 hours	2 hours
	Final strength (100%) after:	24 h	24 h	72 h	48 h	24 h	24 h	24 h	24 h	24 h	24 h
WEICON Epoxy Adhesives in fully-cured condition											
Pressure MPa (psi) (DIN EN ISO 604):	9 (1.300)	9 (1.300)	2 (300)	10 (1.500)	10 (1.500)	52 (7.540)	60 (8.700)	9 (1.300)	8 (1.200)	10 (1.500)	
Tensile MPa (psi) (DIN EN ISO 527-2):	40 (5.800)	40 (5.800)	35 (5.100)	40 (5.800)	24 (3.500)	27 (3.910)	50 (7.200)	40 (5.800)	34 (5.000)	24 (3.500)	
Torsion DIN EN ISO 527-2 MPa (KSI)	2.000 - 2.500 (300 - 400)	2.000 - 2.500 (300 - 400)	2.000 - 2.500 (300 - 400)	1.700 - 2.000 (200 - 300)	4.000 - 4.500 (600 - 700)	2.300 - 2.700 (330 - 390)	4.000 - 5.000 (600 - 730)	2.000 - 2.500 (300 - 400)	4.000 - 4.500 (600 - 700)	4.000 - 4.500 (600 - 700)	
Biege MPa (psi) (DIN EN ISO 178):	58 (8.400)	58 (8.400)	50 (7.300)	50 (7.300)	58 (8.400)	46 (6.670)	40 (5.800)	58 (8.400)	58 (8.400)	58 (8.400)	
Shore hardness D (DIN ISO 7619):	65	65	55	65	70	80	90	65	45	70	
Average tensile shear strength as per DIN EN 1465 or:	Steel, sand-blasted N/mm ² (psi):	20 (2.900)	20 (2.900)	17 (2.500)	21 (3.000)	20 (2.900)	23 (3.330)	13 (1.900)	20 (2.900)	20 (2.900)	20 (2.900)
	Aluminium, sand-blasted N/mm ² (psi):	19 (2.800)	19 (2.800)	16 (2.300)	19 (2.800)	19 (2.800)	13 (1.880)	9 (1.300)	19 (2.800)	19 (2.800)	19 (2.800)
	Rigid PVC, roughened N/mm ² (psi):	13 (1.900)	13 (1.900)	11 (1.600)	14 (2.000)	11 (1.600)	11 (1.600)	11 (1.600)	13 (1.900)	11 (1.600)	11 (1.600)
Temperature resistance:	-50°C to +80°C (-58°F to +176°F)	-50°C to +80°C (-58°F to +176°F)	-50°C to +100°C (-58°F to +212°F)	-50°C to +100°C (-58°F to +212°F)	-50°C to +145°C ³ (-58°F to +293°F) ³	-50°C to +180°C (-58°F to +356°F) briefly to +230°C (+446°F)	-50°C to +200°C (-58°F to +392°F) briefly to +250°C (+482°F)	-50°C to +80°C (-58°F to +176°F)	-50°C to +120°C (-58°F to +248°F) briefly to +150°C (+302°F)	-50°C to +145°C ³ (-58°F to +293°F) ³	
Linear shrinkage*4:	20 mm/m approx. 2,0 %	20 mm/m approx. 2,0 %	20 mm/m approx. 2,0 %	20 mm/m approx. 2,0 %	3 mm/m approx. 0,3 %	3 mm/m approx. 0,3 %	7 mm/m approx. 0,7 %	20 mm/m approx. 2,0 %	3 mm/m approx. 0,3 %	3 mm/m approx. 0,3 %	
Glass transition temperature	T _g after curing at room temperature	44,7°C	---	48,6°C	52,4°C	44,3°C	54,4°C	---	44,7°C	---	
	T _g after tempering at 80 °C	---	---	---	---	---	---	65°C	---	---	
	T _g after tempering at 90 °C	46,1°C	---	---	---	32,5°C	---	---	46,1°C	---	
	T _g after tempering at 120 °C	---	---	49,8°C	54,2°C	---	44,7°C	---	---	---	

*1 For easier workability when ambient temperatures are low, the double cartridges should be warmed up to room temperature (20°C/+68°F) before application.

*2 These specifications depend on the type and condition of the bonding materials and are only relevant for adhesive bondings. When casting e.g. electronic components, a layer thickness of 10 mm should not be exceeded.

*3 After 20 hours at room temperature (+20°C/+68°F), temper for approx. 14 hours at +100°C (+212°F).

*4 Measured by a 900 mm x 75 mm x 10 mm mould after storage for 7 days at +20°C (+68°F).

Adhesives / Sealants
 Technical Sprays
 Technical Liquids
 Assembly Pastes
 Lubricants
 WEICON TOOLS®
 Other

Epoxy Adhesives

Type selection table

	Easy-Mix S 50	Easy-Mix S 50 yellow	Easy-Mix N 50	Easy-Mix N 5000	Easy-Mix Metal	Easy-Mix HT 180	Easy-Mix HT 250	Epoxy Minute Adhesive	Aluminium Minute Adhesive	Fast Metal Minute Adhesive
Metals (e.g. aluminium, cast iron, brass, stainless steel)	++	++	+	++	++	++	++	+	++	++
Hard plastics* (e.g. rigid PVC)	++	++	++	++	+	+	-	+	+	+
Fibre-reinforced materials (e.g. GFRP, CFRP, fibreglass)	++	++	+	++	++	++	+	+	+	+
Wood (hardwood and softwood)	+	+	+	++	+	+	+	+	+	+
Balsa wood	++	++	++	+	+	+	+	++	+	+
Timber products (e.g. plywood)	+	+	+	+	+	+	+	+	+	+
Glass ceramics	+	+	+	+	+	+	+	+	+	+
Stone (e.g. marble, granite, brick, concrete)	++	++	++	++	++	+	++	++	+	+
Rubber / elastomers	-	-	-	-	-	-	-	-	-	-

Highly suitable (++) Suitable (+) Not suitable (-)

*Except for plastics such as polyethylene, polypropylene, polyacetat, polytetrafluoroethylene and other fluorinated hydrocarbons with naturally adhesive-rejecting surfaces. When following the recommendations above, bonding of dissimilar material pairs such as metals and plastics is also possible.

Chemical resistance of Epoxy Resin Systems after curing*

Medium	Resistance	Medium	Resistance
Acetone	o	Machine oil	+
Ammoniac fumes	+	Methanol Ethanol	+
Petrol	+	Lactic acid	-
Butyl acetate	+	Motor oil	+
Butyl alcohol	+	Naphthalene	-
Calcium hydroxide	+	Sodium chloride	+
Calcium sulphate	+	Sodium carbonate	+
Chlorine gas, liquid and dry	+	Sodium hydroxide	+
Chlorinated water	+	Petroleum	+
Chromic acid	+	Phosphoric acid (0-5%)	+
Diesel fuel oil	+	Phosphoric acid (5-10%)	o
Crude oil and crude oil products	+	Hydrochloric acid	o
Ethylcellulose	+	Nitric acid	-
Formaldehyde	o	Sulphur dioxide	+
Glycerine	+	Carbon disulphide	+
Glycol	o	Sulphuric acid%	-
Caustic potash solution	+	Toluene	-
Potassium carbonate	+	Xylene	-
Kerosene (Jetfuel JP 4)	+	Citric acid	+
Sodium chloride solution	+		
Carbon dioxide	+		
Aliphatic hydrocarbons	+		
Aromatic hydrocarbons	-		
Lactose	+		

+ = resistant o = resistant for a limited time - = not resistant

The a.m. resistances are a short excerpt. Further chemical resistances are available upon request. *The storage of all WEICON Epoxy Adhesives was carried out at +20° C chemical temperature .





Adhesives / Sealants

Technical Sprays

Technical Liquids

Assembly Pastes

Lubricants

WEICON TOOLS®

Other

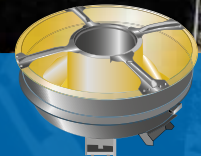
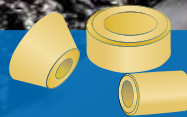
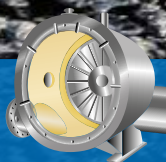
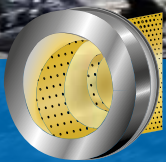

For making:

- ▶ vibration dampers
- ▶ assembling jigs
- ▶ flexible seals
- ▶ rubber-like prototypes
- ▶ foundry patterns and forms

For repairs on:

- ▶ conveyor belts
- ▶ solid rubber tyres
- ▶ conveyor rollers

For coatings on:

- ▶ rollers
- ▶ centrifuges
- ▶ polishing drums
- ▶ bulk containers
- ▶ chutes and funnels
- ▶ dry and wet mixers
- ▶ pumps
- ▶ housings
- ▶ centrifuges
- ▶ tanks
- ▶ loading areas

i In addition, WEICON Urethanes are perfectly suitable as vibration or insulation protection of machines.

Pre-treatment of the surface and accessories



Primer M 100

For non-absorbent materials like aluminium, steel, stainless steel, brass, zinc, tinplate, plastics like PA 6.6, GRP, PUR, lacquered surfaces, enamel, ceramic and coated glass

- ▶ 25 ml **13550102**
- ▶ 250 ml **13550125**

Primer S 300

For porous and absorbent materials like wood, concrete, stone, etc.

- ▶ 25 ml **13550302**
- ▶ 250 ml **13550325**

Primer G

Special bonding agent for urethanes for the pre-treatment of rubber and metal surfaces.

- ▶ 50 g **10809050**

Urethane Colour Paste

Special colour paste on the basis of finely dispersed pigments

- ▶ 250 ml **10519250**

Primer Applicator

For application of WEICON Primer

- 13955050**

Polyurethane Systems

Urethanes

Belt Repair-Kit

Fast-curing 2-component polyurethane system | highly elastic | wear-resistant | impact- and abrasion-resistant | high tear resistance



- ▶ Belt Repair-Kit 550
10851005
- ▶ Belt Repair-Kit 590
10851015

Urethane 45

Shore hardness: A 45

- ▶ 500 g
10514005

Urethane 60

Shore hardness: A 60

- ▶ 500 g
10516005

Urethane 80

Shore hardness: A 80

- ▶ 500 g
10518005

Urethane 85

Shore hardness: A 85

- ▶ 500 g
10800005 package
- ▶ 540 g
10800540 cartridge

Urethane 90 SF

Shore hardness: D 90

- ▶ 550 g
10519005

VIDEO



Technical Data:

	WEICON Urethanes in non-cured condition					
	Urethane 45	Urethane 60	Urethane 80	Urethane 85	Urethane 90 SF	
Basis:	Polyurea	Polyurea	Polyurea	Polyurea	Polyurethane	
Complete packaging sizes:	500 g	500 g	500 g	500 g, 540 g	550 g	
Mixing ratio (weight %): Resin/Hardener	100 : 180	100 : 150	100 : 80	10 : 100	100 : 23	
Pot life at +20°C (68°F) min.:	25	25	25	20	8	
Density of the mixture (g/cm ³):	1,04	1,04	1,00	1,10	1,60	
Viscosity at +25°C (77°F) Resin/Hardener (mPa.s):	5.000 / 500	5.000 / 520	5.000 / 190	500 / 14.000	5.500 / 200	
Mixture viscosity at +25°C (77°F) (mPa.s):	1.500	1.500	2.000	17.000	3.000	
Cure times at +20°C (68°F)	High mechanical load capacity / detachable after	12 - 20 h	12 - 20 h	12 - 20 h	6 - 8 h	2 - 3 h
	Final strength (100%) after:	approx. 48** h	approx. 48** h	approx. 48** h	approx. 24** h	approx. 24** h
	WEICON Urethanes in cured condition					
Tensile strength according to DIN EN ISO 527-2 MPa (psi):	3,5 (600)	5,0 (800)	8,0 (1.200)	7,8 (1.100)	-	
Elongation at break according to DIN EN ISO 527-2 (%):	1.450	1.250	600	470	1	
Resistance to further tearing (DIN ISO 34-1) (kN/m):	7,5	10	15	31	-	
Shore hardness (DIN ISO 7619):	A 45	A 60	A 80	A 85	D 90	
Colour after curing:	light-beige	light-beige	light-beige	black	brown	
Temperature resistance:	-60°C to +90°C (-76 to +194°F)	-60°C to +90°C (-76 to +194°F)	-60°C to +90°C (-76 to +194°F)	wet: -60°C to +80°C (-76 to +176°F) dry: -60°C to +100°C (-76 to +212°F)	-60°C to +90°C (-76 to +194°F)	

** or after 24 hours at room temperature + 4 hours +70°C

	Material	Recommended pre-treatment	
Aluminium	ABS	Surface Cleaner	
	blank	Surface Cleaner + roughening + Primer M 100	
	chromated	Surface Cleaner	
	anodized	Surface Cleaner + Primer M 100	
	powder-coated	Surface Cleaner + Primer M 100	
	base-coated	Surface Cleaner	
EPDM	lacquered	Primer M 100	
	EPDM	poor adhesion, even with the use of a primer	
	smooth/rough side	Primer M 100	
GFK	in strips	Primer M 100	
	hand laminate	Primer M 100	
Glass	untreated, clear	Primer M 100**	
	ceramic-coated	Primer M 100*	
Wood	phenol-coated (serigraphy plate)	Surface Cleaner + roughening + Primer M 100	
	untreated	cleaning with a moist cloth + Primer S 300	
Polywood	PA (polyamide)	Primer M 100*	
	PIR Rigid foam (polyisocyanurat)	Surface Cleaner	
	PMMA (acrylic glass)	Primer M 100*	
	Polywood	roughening + Surface Cleaner	
	PS	rigid foam	Surface Cleaner
		plates	not recommended for Urethane applications
	PUR Rigid foam	Surface Cleaner	
	PUR Elastomer	Surface Cleaner + Primer M 100	
	PVC	plates	Surface Cleaner
		rigid foam	Plastic Cleaner
Steel	blank	Surface Cleaner + Primer M 100	
	chromated	Surface Cleaner	
	foil-coated	not recommended for Urethane applications	
	base-coted	Surface Cleaner + Primer M 100	
	lacquered	Surface Cleaner + Primer M 100	
	powder-coated	Surface Cleaner + Primer M 100	
	VA (stainless steel)	Surface Cleaner + roughening + Primer M 100	
galvanized	Surface Cleaner + roughening + Primer M 100		

* preliminary tests required

** protect from UV-light

Consumption

Layer thickness (mm):	0,20*	0,50	1,00	1,50	2,00	2,50	3,00	3,50	4,00
Consumption per m ² (kg)									
Urethane 45, 60, 80, 85	0,21	0,53	1,05	1,60	2,10	2,65	3,20	3,70	4,20
Urethane 90 SF	0,32	0,80	1,60	2,40	3,20	4,00	4,80	5,60	6,40

*Min. layer thickness



Fast Reliable Strong adhesion

High-strength, fast-curing 2-component structural adhesives based on polyurethane with excellent adhesion to a broad range of materials. The high-viscosity formulation enables application even on vertical surfaces. The 2-component system also provides fast and controlled curing. This makes the adhesive bonding process virtually independent of layer thickness, humidity and ambient temperature.

The following materials can be bonded among themselves or to each other with a high tensile, shearing and impact strength:

- ▶ fibre composite materials (e.g. EP-GRP, UP-GRP, CFC, SMC and fibreglass)
- ▶ plastics (e.g. PVC, ABS, PMMA, PC and phenol)
- ▶ polyurethane, epoxies and polyester
- ▶ steel, aluminium and stainless steel
- ▶ wood, ceramic, etc.

WEICON Easy-Mix PU-90 / PU-240 / PU Crystal adhesives are characterised by the following properties:

- ▶ fast initial strength
- ▶ immediate adhesion even to vertical surfaces, no dripping, can be modelled
- ▶ high tensile, shear and impact strengths
- ▶ permanently elastic/impact resistant, low shrinkage
- ▶ for indoor and outdoor use
- ▶ resistant to weathering and chemicals
- ▶ can be sanded and painted after approx. 30 minutes
- ▶ neutral to materials
- ▶ temperature-resistant from -55°C to +125°C (-67 to +257°F)



Easy-Mix PU-90

High strength | extremely fast-curing | highly viscous | pot life of 90 seconds

▶ 50 ml
10751050

Easy-Mix PU-240

High strength | extremely fast-curing | highly viscous | pot life of 240 seconds

▶ 50 ml
10753050

Easy-Mix PU Crystal

high-strength | fast-curing | UV-resistant | for transparent and visually appealing adhesive bonds | pot life approx. 120 - 240 seconds

▶ 50 ml
10758050

Hand Dispenser D50

10653050

Quadro Mixing Nozzle

10650005

Adhesives / Sealants

Technical Sprays

Technical Liquids

Assembly Pastes

Lubricants

WEICON TOOLS®

Other

Polyurethane Systems

PU-90 PU-240



Chemical resistance of WEICON Polyurethane Systems after curing

Acetone	-	Methyl ethyl ketone	-
Alcohol	0	Mineral and synthetic motor oil	+
Formic acid (concentrated)	-	20% Sodium hydroxide solution	-
10% Ammonia	0	5% Phosphoric acid	+
Petrol (92 to 100 octane)	-	Phosphoric acid (concentrated)	-
Diesel/heating oil	-	2-Propanol	-
Glycol ether	-	5% Nitric acid	-
> 5% Acetic acid	-	5% Hydrochloric acid	+
Ethanol	-	Salt water/seawater	+
Freon	-	5% Sulphuric acid	o
Antifreeze	+	Silicone oil (concentrated)	-
Gear oil	-	Edible oil/vegetable oil	-
Glycerine (glycol)	+	Toluene	+
Hydraulic oil	0	Naphtha	+
20% Caustic potash solution	+	Water	+
Ketones	-	Water, +90°C	o
Cooling lubricant, water-dilutable	+	W3% Hydrogen peroxide	+
Thinner	-	Paraffin oil	+
Lyes, thinned	+	Xylene	+
Methanol	-	10% Citric acid	+

+ = resistant 0 = resistant for a limited time - = not resistant

Technical Data

	Easy-Mix PU-90	Easy-Mix PU-240	Easy-Mix PU Crsytal	
Basis	Polyurethane	Polyurethane	Polyurethane	
Mixing ratio resin/hardener	1 : 1	1 : 1	1 : 1	
Colour after curing	black	black	crystal-clear	
Density of the mixture	1,30 - 1,35 g/cm ³	1,30 - 1,35 g/cm ³	1,13 g/cm ³	
Pot life at +20°C (+68°F)	90 sec.	240 sec.	2 - 4 min.	
Handling strength (35%) after	5 min.	10 min.	30 min.	
Mechanical loads (50% strength) after	10 min.	30 min.	60 min.	
Final strength (100%) after	12 h	12 h	12 h	
Adhesive gap bridging	0,1 - 4,0 mm	0,1 - 4,0 mm	0,1 - 4,0 mm	
On Aluminium (0,26 mm)	13 N/mm ² (1.900 psi)	14 N/mm ² (2.000 psi)	11 N/mm ² (1.600 psi)	
On Steel bright (0,26 mm)	19 N/mm ² (2.800 psi)	23 N/mm ² (3.300 psi)	17 N/mm ² (2.500 psi)	
On Stainless steel (0,26 mm)	17 N/mm ² (2.500 psi)	18 N/mm ² (2.600 psi)	17 N/mm ² (2.500 psi)	
Average E-module +20°C (+68°F)	650 - 750 N/mm ² (90 - 110 ksi)	450 - 550 N/mm ² (70 - 80 ksi)	240 - 280 N/mm ² (35 - 40 ksi)	
Shore hardness D (DIN ISO 7619)	66	68	73	
Tensile strength DIN EN ISO 527-2	21 N/mm ² (3.000 psi)	20 N/mm ² (2.900 psi)	12 N/mm ² (1.750 psi)	
Tensile Extension DIN EN ISO 527-2	35%	31%	20%	
Temperature resistance	-55 to +125°C (-67 to +257°F)	-55 to +125°C (-67 to +257°F)	-55 to +100°C (-67 to +212°F)	
Thermoforming resistance	+65°C (+149°F)	+65°C (+149°F)	+50°C (+122°F)	
TGA decomposition temperature (onset-temp.)	+330°C (+626°F)	+336°C (+637°F)	-	
Glass transition temperature	T _g after curing at room temperature	45,6°C	30,9°C	48,0°C
	T _g after tempering at 120 °C	31,1°C	27,0°C	-

VIDEO



Adhesives / Sealants

Technical Sprays

Technical Liquids

Assembly Pastes

Lubricants

WEICON TOOLS®

Other

WEICON RK-1300/1500 are 2-component systems based on methacrylate, which cure fast at room temperature. Both systems are processed in the “no-mix” procedure, i.e. a mix of both components (adhesive and activator) is not necessary.

Polymerization starts as soon as the adhesive- and activator-wetted components are joined together.



Activator

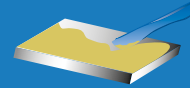

Adhesive



Join together

High strength | impact-resistant



RK-1300/1500 allow high-strength bonding of different materials:

- ▶ **metals (also coated), such as steel, aluminium, copper, zinc, alloys, as well as ferrites (ferromagnetic material)**
- ▶ **plastics*, such as ABS, polystyrene, hard PVC, polycarbonate, polyphenylene oxide, polyester moulding compounds**
- ▶ **fibre composite materials (GRP, CRP, fibreglass etc.)**
- ▶ **wood and cellulose materials (e.g. MDF)**
- ▶ **glass, ceramics and stone**

*Polyamide, Teflon® and polyolefin etc. only after special surface treatment, for example using fluoridation, low-pressure plasma, corona, flame impingement etc.

WEICON RK-1300/1500 feature special product-specific characteristics:

- ▶ **processing in the “no-mix” procedure**
- ▶ **quick and high initial bonding strength**
- ▶ **residual elasticity and impact resistance**
- ▶ **applicable at a large range of temperatures**
- ▶ **ageing-resistant**

As a result, there are numerous areas of application, in particular during assembly and in industrial processing.

Due to the “no-mix” procedure and the quick, high initial bonding strength, WEICON RK Construction Adhesives are especially suited for manufacturing processes with staggered assembly and positioning processes and high cycle times during serial production.

Structural Acrylic Adhesives

RK-1300
RK-1500



RK-1300

Pasty | strong | fast-curing

- ▶ 60 g¹
10560060
- ▶ 330 g²
10560330
- ▶ 1,0 kg¹
10560800
- ▶ 6,0 kg²
10561906

¹complete package consisting of adhesive and activator
²without activator

RK-1500

Liquid | strong | fast-curing

- ▶ 60 g¹
10563860
- ▶ 310 g²
10563330
- ▶ 1,0 kg¹
10563800
- ▶ 6,0 kg²
10563906

¹complete package consisting of adhesive and activator
²without activator



Bonding of plastic plates (PU)
RK-1500



Illumination bonding (aluminium / glass)
RK-1300



RK-Activator

- ▶ 100 ml
10562100
- ▶ 1 L
10562901



Adhesives / Sealants

Technical Sprays

Technical Liquids

Assembly Pastes

Lubricants

WEICON TOOLS®

Other

The ideal adhesive for **low energy plastics**

High strength Residual elasticity Process-safe



Easy-Mix RK-7300

Excellent adhesion to plastics and EPDM | high strength | highly viscous | impact-resistant

▶ 50 g
10569050



Quadro Mixing Nozzle

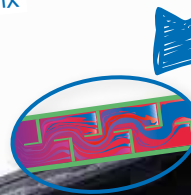

High-strength, fast-curing structural adhesives on the basis of MMA (methyl methacrylate) with excellent adhesion to e.g. fibre composite materials, many plastics, metals and many other materials.

Due to its high viscosity the adhesive can also be applied on vertical surfaces.

The following materials can be bonded with high tensile, shear and peel strength:

- ▶ plastics (e.g. PVC, ABS, PMMA, fibre glass, phenol)
- ▶ polyurethane, epoxies
- ▶ steel, aluminium, stainless steel
- ▶ wood, ceramics and many others

WEICON Easy-Mix Structural Adhesives feature special product characteristics:

- ▶ high tensile, shear and impact strengths
- ▶ rapid strength build-up
- ▶ for indoor and outdoor use
- ▶ resistant to weather conditions and many chemicals
- ▶ sandable and paintable
- ▶ temperature-resistant from -55°C to +125°C (-67 to +257°F)

WEICON Easy-Mix Structural Adhesives can be applied universally and are well-suited for the following areas of application:

- ▶ plastics engineering
- ▶ machine building
- ▶ model and mould construction
- ▶ metal construction
- ▶ electrical engineering
- ▶ car body and vehicle construction
- ▶ trade fair and exhibition



Adhesives / Sealants
Technical Sprays
Technical Liquids
Assembly Pastes
Lubricants
WEICON TOOLS®
Other

Structural Acrylic Adhesives

RK-Structural Adhesives and Plastic Bond



Easy-Mix RK-7000

Slow-curing | high strength | impact-resistant | residual elasticity

► 50 g
10565050

VIDEO



Easy-Mix RK-7100

Fast-curing | high strength | impact-resistant | residual elasticity

► 50 g 10566050
► 50 g 10566150
black



Easy-Mix RK-7200

Transparent | high strength | impact-resistant | residual elasticity

► 50 g
10564050

Plastic-Bond

Excellent adhesion to plastics | high strength | shock- and impact-resistant

► 24 ml
10565024

Can alternatively be processed with Quadro Mixing Nozzle (Art.-No. 10650005).

Plastic-Bond Set **NEW**

Comprising:

Plastic-Bond, Wooden Spatula small, Mixing Nozzle Quadro, PE gloves

► Set
10565025



Our DIY TIP

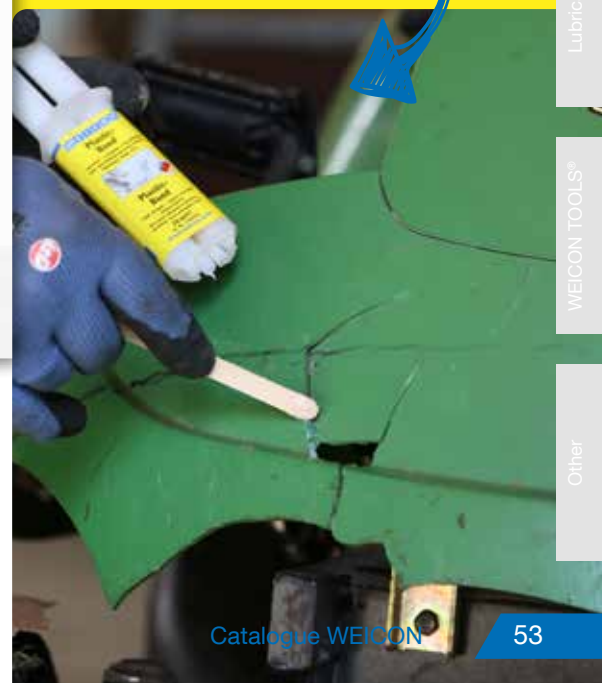

Adhesives / Sealants

Technical Sprays

Technical Liquids

Assembly Pastes

Lubricants

WEICON TOOLS®

Other

Fast High strength Process-safe

Plastics such as PE and PP are used increasingly in nearly all industrial sectors today due to their specific properties such as mouldability, elasticity, break resistance, temperature and heat resistance. For the adhesive bonding of these plastics, until now, the surfaces needed to be extensively pretreated, for example:

- ▶ mechanically (grinding, blasting, etc.)
- ▶ chemically (fluorination)
- ▶ physically (flame treatment, corona, plasma)

With the adhesives WEICON Easy-Mix PE-PP 45 and PE-PP 50, these pretreatments are no longer necessary. The "integrated primer" in the adhesive activates the surfaces and makes high-strength bonds possible.

WEICON Easy-Mix PE-PP 45 and PE-PP 50 are 2-component construction adhesives based on methyl acrylate. They are particularly suitable for structural, high-strength bondings of low surface-energy plastics like PE, PP and TPE.

In addition, WEICON Easy-Mix PE-PP 45 can be used as "universal adhesive" for plastics like:

- ▶ rigid PVC (polyvinyl chloride)
- ▶ PC (polycarbonate)
- ▶ ABS (acrylonitrile-butadiene styrene)
- ▶ fibre-reinforced materials (GRP, CRP, fibre glass etc.) and many others.

Characteristics:

- ▶ no pre-treatment of the parts to be bonded ("integrated primer")
- ▶ short pot life and processing time
- ▶ fast development of strength
- ▶ high final strength
- ▶ curing with residual elasticity
- ▶ ageing-resistant
- ▶ chemical-resistant
- ▶ pasty, non-drip

Graphical representation of a bonding gap with WEICON Easy-Mix PE-PP

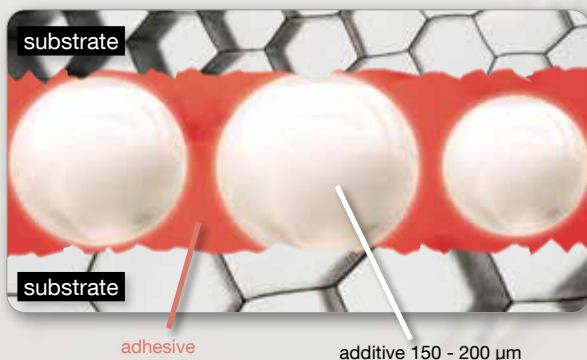

Easy-Mix

Easy-Mix PE-PP 50 NEW

▶ 50 ml
10665050
transparent

Hand Dispenser D50
10653050

Quadro Mixing Nozzle
10650005

Due to its transparent curing, WEICON Easy-Mix PE-PP 50 is especially suitable for creating visually appealing adhesive bonds. Thanks to its special formula, the adhesive is suitable for 0-gap bonds and for connecting surfaces with extremely small bonding gaps of less than 0,2 mm.

- ▶ pot life 6 minutes
- ▶ bonding gap bridging from 0 to 1 mm
- ▶ handling strength after 12 minutes



Structural Acrylic Adhesives

PE-PP 45
PE-PP 50



Easy-Mix PE-PP 45

▶ 45 ml
10660045
nearly colourless, translucent

Hand Dispenser PE-PP

10663045

Mixing Nozzles PE-PP

10660002

Special Piston

10663110

For retooling the Hand Dispenser Easy-Mix D 50 to Easy-Mix PE-PP 45



Due to its slightly higher viscosity, WEICON Easy-Mix PE-PP 45 compensates bonding gaps of up to 1 mm and, thanks to the fillers (glass beads) contained in the adhesive, guarantees adhesive joint of at least 0,20 mm.

- ▶ pot life 2-3 minutes
- ▶ bonding gap bridging min. 0,15 - 0,20 mm
- ▶ handling strength after 120 - 180 minutes

Ageing resistance of PE adhesive bonds

Ageing resistance of PP adhesive bonds

after storage in various media
(14 days at room temperature)

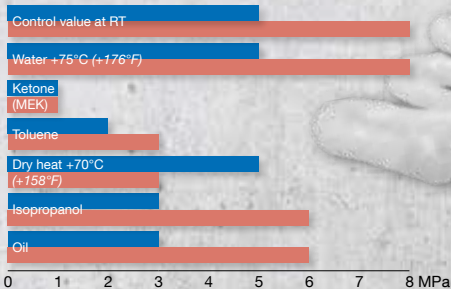

Specification of the test specimen:
Standard: DIN EN 1465 Curing: 7 days at room temperature
Adhesive surface: 12,5 mm x 25 mm Testing speed: 10 mm/min
Adhesive thickness: 0,2 mm

Tensile shear strength of WEICON Easy-Mix PE-PP 45 compliant with DIN EN 1465 in temperature curve

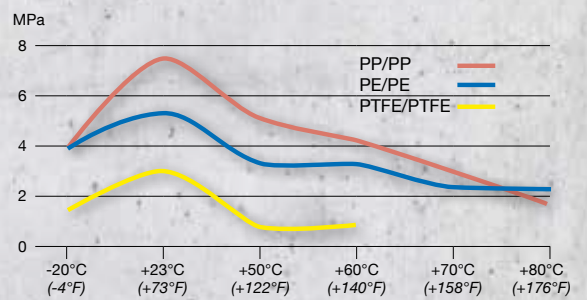

Strength development of WEICON Easy-Mix PE-PP 45 on tensile shear test samples compliant with DIN EN 1465

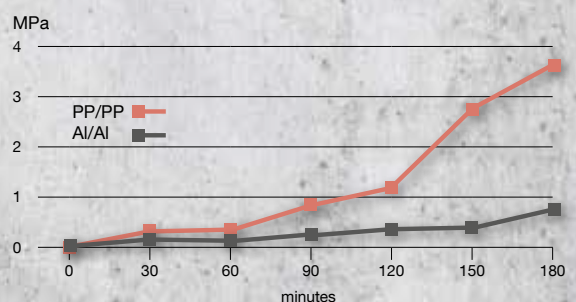

Adhesives / Sealants

Technical Sprays

Technical Liquids

Assembly Pastes

Lubricants

WEICON TOOLS®

Other

Technical Data

	RK-1300	RK-1500	RK-7000	RK-7100	RK-7100 black	RK-7200	RK-7300	PE-PP 45	PE-PP 50	Plastic-Bond
Basis	Methyl methacrylate	Methyl methacrylate	Methyl methacrylate	Methyl methacrylate	Methyl methacrylate	Methyl methacrylate	Methyl methacrylate	Methyl methacrylate	Methyl methacrylate	Methyl methacrylate
Mixing ratio resin / hardener	1 : 1	1 : 1	1 : 1	1 : 1	1 : 1	1 : 1	1 : 1	10 : 1	1 : 1	1 : 1
Colour after curing	beige, opaque	yellowish, transparent	cream white, milky	cream white, milky	black	transparent	translucent/creamy white	nearly colourless, translucent	transparent	cream white, milky
Density of the mixture	-	-	0,98 - 1,02 g/cm ³	0,98 - 1,02 g/cm ³	0,98 - 1,02 g/cm ³	1,1 g/cm ³	1,00 g/cm ³	1,07 g/cm ³	1,00 g/cm ³	0,98 - 1,02 g/cm ³
Pot life at +20°C (+68°F)	-	-	approx. 15 min.	approx. 5 min.	approx. 5 Min.	approx. 1 - 2 min.	approx. 8 min.	approx. 2 - 3 min.	approx. 6 min.	approx. 15 min.
Viscosity of the mixture (mPa.s)	21.000 (Adhesive)	4.500 (Adhesive)	40.000 - 60.000	40.000 - 60.000	40.000 - 60.000	5.000 - 6.000	170.000 - 200.000	45.000	20.000	40.000 - 60.000
Adhesive gap bridging	max. 0,40 mm (Activator application on one side**)		0,1 - 5,0 mm	0,1 - 5,0 mm	0,1 - 5,0 mm	0,1 - 2,0 mm	0,25 - 1,0 mm	0,25 - 1,0 mm	0 - 1,0 mm	0,1 - 5,0 mm
	max. 0,80 mm (Activator application on both sides**)									
Temperature resistance	-50°C to +130°C (-58 to +266°F), briefly (30 minutes) to +180°C (+356°F)		-55 to +125°C (-67 to +257°F)	-55 to +125°C (-67 to +257°F)	-55 to +125°C (-67 to +257°F)	-40 to +120°C (-40 to +248°F)	-55 to +100°C (-67 to +212°F)	-50 to +80°C (-58 to +176°F)	-50 to +80°C (-58 to +176°F) briefly to +100°C (+212°F)	-55 to +125°C (-67 to +257°F)
Handling strength (35%) after	approx. 6 min.	approx. 5 min.	approx. 40 min.	approx. 25 min.	approx. 25 min.	3 - 5 min.	approx. 1 h	2 - 3 h (PP-PP) 6 h (Alu-Alu)	approx. 12 min.	approx. 40 min.
Mechaniapprox. loads (50% strength) after	approx. 9 min.	approx. 8 min.	approx. 60 min.	approx. 60 min.	approx. 60 min.	approx. 120 min.	approx. 8 h	3 - 4 h (PP-PP) 24 h (Alu-Alu)	approx. 12 h	approx. 60 min.
Final strength (100%) after	approx. 24 h	approx. 24 h	approx. 12 h	approx. 12 h	approx. 12 h	approx. 6 h	approx. 24 h	24 h (PP-PP) 72 h (Alu-Alu)	approx. 24 h	approx. 12 h
Shore hardness D DIN ISO 7619	-	-	70	75	75	45 - 55	40 - 50 D	55	55	70
Tensile strength DIN EN 1465:										
- Aluminium	20 N/mm ² (2.900 psi)	20 N/mm ² (2.900 psi)	20 N/mm ² (2.900 psi)	20 N/mm ² (2.900 psi)	20 N/mm ² (2.900 psi)	19 N/mm ² (2.760 psi)	5 N/mm ² (730 psi)	14 N/mm ² (2.030 psi)	12 N/mm ² (1.740 psi)	20 N/mm ² (2.900 psi)
- Steel	25 N/mm ² (3.600 psi)	25 N/mm ² (3.600 psi)	23 N/mm ² (3.300 psi)	23 N/mm ² (3.300 psi)	23 N/mm ² (3.300 psi)	22 N/mm ² (3.190 psi)	5 N/mm ² (730 psi)	17 N/mm ² (2.470 psi)	12 N/mm ² (1.740 psi)	23 N/mm ² (3.300 psi)
- Stainless Steel	25 N/mm ² (3.600 psi)	30 N/mm ² (4.350 psi)	22 N/mm ² (3.190 psi)	22 N/mm ² (3.190 psi)	22 N/mm ² (3.190 psi)	27 N/mm ² (3.900 psi)	4 N/mm ² (580 psi)	16 N/mm ² (2.320 psi)	11 N/mm ² (1.600 psi)	22 N/mm ² (3.190 psi)
- PC (polycarbonate)	10 N/mm ² (1.450 psi)	10 N/mm ² (1.450 psi)	11 N/mm ² (1.600 psi)	12 N/mm ² (1.740 psi)	12 N/mm ² (1.740 psi)	7 N/mm ² (1.020 psi)	6 N/mm ² (870 psi)	6 N/mm ² (870 psi)	6 N/mm ² (870 psi)	11 N/mm ² (1.600 psi)
- PMMA	9 N/mm ² (1.310 psi)	8 N/mm ² (1.160 psi)	9 N/mm ² (1.310 psi)	9 N/mm ² (1.310 psi)	9 N/mm ² (1.310 psi)	4 N/mm ² (580 psi)	6 N/mm ² (870 psi)	7 N/mm ² (1.000 psi)	8 N/mm ² (1.160 psi)	9 N/mm ² (1.310 psi)
- ABS	6 N/mm ² (900 psi)	6 N/mm ² (900 psi)	7 N/mm ² (1.000 psi)	7 N/mm ² (1.000 psi)	7 N/mm ² (1.000 psi)	7 N/mm ² (1.000 psi)	8 N/mm ² (1.160 psi)	11 N/mm ² (1.600 psi)	3 N/mm ² (440 psi)	7 N/mm ² (1.000 psi)
- rigid PVC	7 N/mm ² (1.000 psi)	11 N/mm ² (1.600 psi)	12 N/mm ² (1.740 psi)	12 N/mm ² (1.740 psi)	12 N/mm ² (1.740 psi)	8 N/mm ² (1.160 psi)	11 N/mm ² (1.600 psi)	14 N/mm ² (2.030 psi)	12 N/mm ² (1.740 psi)	12 N/mm ² (1.740 psi)
- GFK	16 N/mm ² (2.300 psi)	20 N/mm ² (2.900 psi)	21 N/mm ² (3.000 psi)	21 N/mm ² (3.000 psi)	21 N/mm ² (3.000 psi)	9 N/mm ² (1.310 psi)	7 N/mm ² (1.000 psi)	17 N/mm ² (2.470 psi)	15 N/mm ² (2.200 psi)	21 N/mm ² (3.000 psi)
- CFK	24 N/mm ² (3.500 psi)	27 N/mm ² (3.920 psi)	22 N/mm ² (3.190 psi)	22 N/mm ² (3.190 psi)	22 N/mm ² (3.190 psi)	12 N/mm ² (1.740 psi)	7 N/mm ² (1.000 psi)	16 N/mm ² (2.320 psi)	12 N/mm ² (1.740 psi)	22 N/mm ² (3.190 psi)
- Polyamide 6.6	2 N/mm ² (300 psi)	3 N/mm ² (400 psi)	1 N/mm ² (150 psi)	1 N/mm ² (150 psi)	1 N/mm ² (150 psi)	2 N/mm ² (290 psi)	3 N/mm ² (440 psi)	6 N/mm ² (870 psi)	2 N/mm ² (290 psi)	1 N/mm ² (150 psi)
- POM (polyoxymethylen)	-	-	-	-	-	-	5 N/mm ² (730 psi)	2 N/mm ² (290 psi)	-	-
- PE-HD	-	-	-	-	-	-	5 N/mm ² (730 psi)	7 N/mm ² (1.000 psi)	-	-
- PP (polypropylene)	-	-	-	-	-	-	6 N/mm ² (870 psi)	8 N/mm ² (1.160 psi)	8 N/mm ² (1.160 psi)	-
- PTFE (polytetrafluorethylene)	-	-	-	-	-	-	2 N/mm ² (290 psi)	-	-	-
- EPDM (Shore A70)	-	-	-	-	-	-	1 N/mm ² (150 psi)	-	-	-
Glass transition temperature										
T _g after curing at room temperature	-	-	-39,8°C	-40,3°C	-40,3°C	-17,5°C	51,5°C	46,3°C	-	-
T _g after tempering at 120 °C	-	-	-39,5°C	-38,5°C	-38,5°C	-17,7°C	52,4°C	44,7°C	-	-

*This information is dependent on the type of materials to be bonded and their respective properties. In case of porous materials or passive surfaces, such as chrome, nickel, etc. the Activator should be applied on both sides. (Bond lines of 0.15 mm to 0.25 mm in width have the highest stability).

Structural Acrylic Adhesives

RK-Structural Adhesives and Plastic Bond

Chemical resistance of WEICON Structural Acrylic Adhesives after curing*

Acetone	+	Isopropyl acetate	+
Acidic vapours	+	Isopropyl alcohol	+
Alcohol	+	Isopropyl ether	+
Aliphatic hydrocarbons, (petroleum derivative)	+	Kerosene	+
Alkaline vapours	+	Ketone	+
Ammonia, ammonium chloride	+	Lubricating oils and grease	+
Ammonium chloride	+	Mercury	+
Aromatic hydrocarbons (benzoyl, methylbenzene, xylene)	0	Methanol (methyl alcohol)	+
Benzoyl	0	Methyl benzoyl	+
Benzoyl acid	+	Methyl chloride	0
Bilge medium (bilge water)	+	Methyl ethyl ketone	+
Brake fluid	+	Methyl isobutyl ketone, isopropyl acetone	+
Bromide solution	0	Methylene dichloride	+
Butyl alcohol (Isobutanol)	+	Mineral oil	+
Calcium chloride (sea salt)	+	Mineral turpentine	+
Calcium sulphate	+	Nitric acid 5%	+
Calcium sulphite	+	Nitric acid, fuming	-
Chlorinated hydrocarbon	+	Oxygen	-
Chlorinated salt water (swimming pool concentrate)	+	Ozone	-
Chlorinated solvent (dichloromethane)	-	Paraffin oil, kerosene	+
Chlorinated water (swimming pool concentration)	+	Perchlormethylmercaptan	+
Chlorine alcohol	+	Persulfuric acid 5%	+
Chlorine bleach	-	Petrol	+
Chlorine gas, liquid and dry	-	Phenol (Carbolic acid)	+
Chlorine sulphuric acid	-	Phenol resin	+
Chlorine, liquid and dry	-	Phosphoric acid 5%	+
Chloroform	+	Phthalic acid (benzene dicarboxylic acid)	+
Chromic acid 5%	+	Polyphosphoric acid 5%	+
Cooling lubricants	+	Potassium carbonate (potash)	+
Corrosive ammonium, ammonium hydroxide	0	Propyl alcohol	+
Cylinder oil	+	Selenium chloride	+
Dichloroethylene ether	+	Silicon oils	+
Epichlorohydrin	+	Sulphur dioxide, wet and dry	+
Freon	0	Sulphur trioxide gas	-
Fuel for jet or turbine engines	+	Sulphuric acid	0
Glycocol, glycine	+	Sulphuric acid, fuming	-
Heating oil, diesel	+	Tannic acid (gallotannic acid)	0
Heptane	+	Toluene (methylbenzene)	0
Hydrochloric acid (muriatic acid)	0	Toluene sulphuric acid	0
Hydrocyanic acid, prussic acid 5%	+	Trichloroethylene	+
Hydrogen bromide 5%	+	Turpentine, Turpentine oil	+
Hydrogen chloride	+	Waste water, excrements	+
Hydrogen fluoride (hydrofluoric acid)	-	Water	+
Hydrogen peroxide	0	Water, boiling	0
Hydrogen sulphide, wet and dry	+	Water, distilled	+
Isobutyl alcohol (isobutene)	+	Xylene (dimethylbenzoyl)	0

+ = resistant 0 = resistant for a limited time - = not resistant *Storage of the test pieces was at +20°C (+68°F) chemical temperature.



WEICONLOCK®

Threadlocking

Product	Page
AN 301-43	62
AN 301-70	62
AN 302-21	62
AN 302-22	62
AN 302-40	62
AN 302-41	63
AN 302-42	63
AN 302-43	63
AN 302-44	63
AN 302-50	64
AN 302-60	64
AN 302-62	64
AN 302-70	64
AN 302-71	64
AN 302-72	65
AN 302-90	65

Pipe and Thread Sealing

AN 301-65	66
AN 301-72	66
AN 302-25	66
AN 302-45	66
AN 302-75	66
AN 302-77	67
AN 302-80	67
SI 303-31	67
AN 305-11	67
AN 305-42	68
AN 305-67	68
AN 305-72	68
AN 305-77	68
AN 305-78	69
AN 305-86	69

Retaining Cylindrical Assemblies

AN 301-38	70
AN 301-48	70
AN 306-00	70
AN 306-01	70
AN 306-03	71
AN 306-10	71
AN 306-20	71
AN 306-30	71
AN 306-38	72
AN 306-40	72
AN 306-41	72
AN 306-48	73
AN 306-60	73

Flange Sealing and Gasketing

AN 301-65	74
AN 301-72	74
AN 305-10	74
AN 305-18	74
AN 305-67	74
AN 305-72	75
AN 305-73	75
AN 305-74	75

Additional products

Product	Page
Gasket Maker	80
Plast-o-Seal®	81
Thread Sealing Cord DF 175	82
Threadlocking Varnish	83

Cyanoacrylate Adhesives - Contact

VA 20	85
VA 8312	85
Contact Filler	85
VA 8406	86
VA 100	86
VA 110	86
VA 1401	87
VA 300	87
VA 1500	87
Contact GEL	87
VA 2500 HT	88
VA 180 HT	88
VA 200 HR	88
VA 30 Black	89
VA 250 Black	89
VA 1408	90
VA 1460	90
VA 1403	90
VM 20	91
VM 120	91
VM 2000	91
O-Ring Bonding Set	92
Accessories for CA	93

1-Component Adhesives and Sealants



Adhesives / Sealants

Technical Sprays

Technical Liquids

Assembly Pastes

Lubricants

WEICON TOOLS®

Other



Adhesives / Sealants

Threadlocking

- ▶ screws and nuts
- ▶ stud bolts

Technical Sprays

Sealing of threaded pipes and fittings

- ▶ threaded connections
- ▶ hydraulic and pneumatic systems
- ▶ cooler and compressed air systems

Technical Liquids

Retaining cylindrical assemblies

- ▶ shaft / hub-connections
- ▶ coupling hubs, pulleys, bearings
- ▶ cylindrical parts;
slip-, press- or shrunk-fitted

Assembly Pastes

Lubricants

Flange sealing, gasketing

- ▶ flanges
- ▶ cases
- ▶ lids

WEICON TOOLS®

Other

WEICONLOCK are one-component anaerobic adhesives and sealants, especially made for metal assembly parts.

For different application areas, our broad range of various strengths and viscosities is available for you.

WEICONLOCK is suitable for all metals and certain plastics. It can be applied either manually or semi / fully automatically. As cost-effective problem solvers, WEICONLOCK products are indispensable in many sectors of industry:

- ▶ automotive industry
- ▶ engine and plant construction
- ▶ manufacture of pumps and pipes
- ▶ hydraulic and pneumatic equipment
- ▶ precision mechanics
- ▶ in electrical engineering and electro-technics and in nearly all fields of repair and maintenance



BAM tested and safety-related evaluated- according to leaflet M 031-1 "List of nonmetallic materials compatible with oxygen" (DGVV information 213-078) of BG RCI

NSF

Certified to NSF/ANSI 61

NSF

Nonfood Compounds Program Listed (Category Code) (Registration #)



Anaerobic Adhesives and Sealants



WEICONLOCK Activator F

Reduction of curing time

The cure time can be reduced considerably by pre-treatment with WEICONLOCK Activator F, which is recommended for all passive surfaces and which is indispensable at low ambient temperatures (+10°C/+50°F and below) and for large gaps. On non-metallic surfaces, WEICONLOCK is made effective by using the activator.

- ▶ 60 ml ▶ 200 ml ▶ 1 L
- 30700060** **30700200** **30700501**
- Pen Spray Aluminium can



Dosing Tip

For exact, economic and point-to-point applications of WEICONLOCK.

- 30955172**
- Dosing tip Type L
- Gr. 1



VIDEO



WEICON Pen-System



- ▶ facilitates the work of your employees thanks to its easy handling and ensures a flawless application
- ▶ comfortable use like a pen, which allows flawless, safe and precise dispensing of the adhesives and sealants
- ▶ resource-saving processing

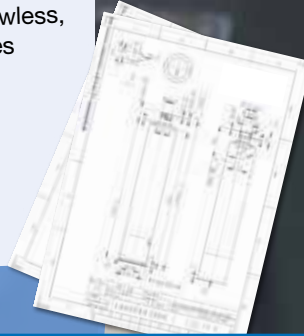

Adhesives / Sealants

Technical Sprays

Technical Liquids

Assembly Pastes

Lubricants

WEICON TOOLS®

Other

AN 301-43



Certified to NSF/ANSI 61



Threadlocking | classified as non-hazardous | drinking water approval and DVGW approval

- ▶ higher viscosity
- ▶ medium strength
- ▶ disassembly with normal tools

▶ 20 ml 30143020 ▶ 50 ml 30143150 ▶ 200 ml 30143200



AN 301-70



Certified to NSF/ANSI 61

Threadlocking | classified as non-hazardous | drinking water approval

- ▶ medium viscosity
- ▶ high strength
- ▶ hard to disassemble

▶ 20 ml 30170020 ▶ 50 ml 30170150 ▶ 200 ml 30170200



AN 302-21

Threadlocking | vibration-proof | classified as non-hazardous

- ▶ low viscosity
- ▶ low strength
- ▶ easy disassembly

▶ 20 ml 30221020 ▶ 50 ml 30221150 ▶ 200 ml 30221200



AN 302-22

Threadlocking | vibration-proof | classified as non-hazardous

- ▶ medium viscosity
- ▶ low strength
- ▶ easy disassembly

▶ 20 ml 30222020 ▶ 50 ml 30222150 ▶ 200 ml 30222200



AN 302-40



Threadlocking | vibration-proof | DVGW approval | classified as non-hazardous

- ▶ medium viscosity
- ▶ medium strength
- ▶ disassembly with normal tools

▶ 20 ml 30240020 ▶ 50 ml 30240150 ▶ 200 ml 30240200



WEICONLOCK® Threadlocking

AN 302-41

Threadlocking | vibration-proof

- ▶ low viscosity
- ▶ medium strength
- ▶ easy disassembly

▶ 20 ml ▶ 50 ml ▶ 200 ml
30241020 30241150 30241200



AN 302-42

Threadlocking | drinking water approval

- ▶ medium viscosity
- ▶ medium strength
- ▶ disassembly with normal tools

▶ 20 ml ▶ 50 ml ▶ 200 ml
30242020 30242150 30242200



AN 302-43

Threadlocking | DVGW and drinking water approval

- ▶ higher viscosity
- ▶ medium strength
- ▶ disassembly with normal tools

▶ 10 ml ▶ 20 ml ▶ 50 ml ▶ 200 ml
30243110 30243020 30243150 30243200



AN 302-44

Threadlocking for passive materials* | DVGW and drinking water approval

- ▶ higher viscosity
- ▶ medium strength
- ▶ disassembly with normal tools

▶ 20 ml ▶ 50 ml ▶ 200 ml
30244020 30244150 30244200



* **Passive materials:**
(slow curing)

- ▶ high-alloyed steel
- ▶ aluminium, nickel, zinc, gold
- ▶ oxid layers
- ▶ chromate layers
- ▶ anodic coatings
- ▶ plastics and ceramics



AN 302-50

Locking of threads and stud bolts

- ▶ medium viscosity
- ▶ high strength
- ▶ hard to disassemble



- ▶ 20 ml 30250020
- ▶ 50 ml 30250150
- ▶ 200 ml 30250200



AN 302-60



Threadlocking for passive materials* | drinking water approval

- ▶ medium viscosity
- ▶ high strength
- ▶ hard to disassemble

- ▶ 20 ml 30260020
- ▶ 50 ml 30260150
- ▶ 200 ml 30260200



AN 302-62

Threadlocking

- ▶ higher viscosity
- ▶ strong
- ▶ hard to disassemble

- ▶ 20 ml 30262020
- ▶ 50 ml 30262150
- ▶ 200 ml 30262200



AN 302-71

Locking of threads and stud bolts

- ▶ medium viscosity
- ▶ high strength
- ▶ hard to disassemble

- ▶ 20 ml 30271020
- ▶ 50 ml 30271150
- ▶ 200 ml 30271200



AN 302-70



Locking of threads and stud bolts | drinking water and DVGW approval

- ▶ medium viscosity
- ▶ high strength
- ▶ hard to disassemble

- ▶ 10 ml 30270110
- ▶ 20 ml 30270020
- ▶ 50 ml 30270150
- ▶ 200 ml 30270200



* **Passive materials:** (slow curing)

- ▶ high-alloyed steel
- ▶ aluminium, nickel, zinc, gold
- ▶ oxid layers
- ▶ chromate layers
- ▶ anodic coatings
- ▶ plastics and ceramics

WEICONLOCK® Threadlocking



Due to its low viscosity and high capillary action, it penetrates the thread interstices, without the connection having to be loosened beforehand. Ideal for pre-assembled screw connections.

AN 302-72



Locking of threads and stud bolts | high-temperature-resistant | DVGW- and drinking water approval

- ▶ higher viscosity
- ▶ high strength
- ▶ hard to disassemble

▶ 20 ml ▶ 50 ml ▶ 200 ml
30272020 30272150 30272200



AN 302-90

Threadlocking | for subsequent locking and sealing of hairline cracks

- ▶ extremely low viscosity | high capillary action
- ▶ high strength
- ▶ hard to disassemble

▶ 20 ml ▶ 50 ml ▶ 200 ml
30290020 30290150 30290200



Technical Data

Type-No.	Colour	For threaded joints up to	Viscosity at +25°C (+77°F) Brookfield	Gap filling capacity max.	Breakaway strength (Thread)	Prevailing strength (Thread)	Shear strength N/mm² (DIN 54452)	Handling strength at room temperature	Final strength at room temperature	Temperature resistance
AN 301-43	blue	M 36	2.000 - 8.000 mPa·s	0,25 mm	18 - 22 Nm	9 - 11 Nm	10 - 13 N/mm² (1.450 - 1.885 psi)	5 - 15 min.	1 - 3 h	-60 to +150°C (-76 to +302°F)
AN 301-70	green	M 25	500 - 900 mPa·s	0,15 mm	25 - 35 Nm	40 - 50 Nm	14 - 20 N/mm² (2.030 - 2.900 psi)	5 - 15 min.	5 - 10 h	-60 to +150°C (-76 to +302°F)
AN 302-21	violet	M 12	125 mPa·s	0,10 mm	7 - 10 Nm	3 - 6 Nm	4 - 7 N/mm² (580 - 1.115 psi)	10 - 20 min.	3 - 6 h	-60 to +150°C (-76 to +302°F)
AN 302-22	purple	M 36	1.000 mPa·s	0,20 mm	4 - 8 Nm	2 - 4 Nm	3 - 5 N/mm² (435 - 725 psi)	10 - 20 min.	3 - 6 h	-60 to +150°C (-76 to +302°F)
AN 302-40	transparent	M 20 R 3/4"	600 mPa·s	0,15 mm	12 - 16 Nm	18 - 24 Nm	8 - 12 N/mm² (1.160 - 1.740 psi)	10 - 20 min.	3 - 6 h	-60 to +150°C (-76 to +302°F)
AN 302-41	blue	M 12	125 mPa·s	0,10 mm	10 - 15 Nm	12 - 16 Nm	8 - 12 N/mm² (1.160 - 1.740 psi)	10 - 20 min.	approx. 3 h	-60 to +150°C (-76 to +302°F)
AN 302-42	blue	M 36	1.000 mPa·s	0,20 mm	14 - 18 Nm	5 - 8 Nm	8 - 12 N/mm² (1.160 - 1.740 psi)	10 - 20 min.	3 - 6 h	-60 to +150°C (-76 to +302°F)
AN 302-43	blue	M 36	2.000 - 7.000 mPa·s	0,25 mm	17 - 22 Nm	8 - 12 Nm	9 - 13 N/mm² (1.305 - 1.885 psi)	10 - 20 min.	1 - 3 h	-60 to +200°C (-76 to +392°F)
AN 302-44	blue	M 36	3.000 - 8.000 mPa·s	0,25 mm	17 - 22 Nm 8 - 12 Nm*	8 - 12 Nm 5 - 8 Nm*	9 - 13 N/mm² (1.305 - 1.885 psi)	10 - 20 min. 20 - 40 min.*	1 - 3 h 4 - 8 h*	-60 to +200°C (-76 to +392°F)
AN 302-50	transparent	M 20 R 3/4"	500 mPa·s	0,15 mm	30 - 35 Nm	55 - 70 Nm	25 - 35 N/mm² (3.625 - 5.075 psi)	2 - 5 min.	2 - 4 h	-60 to +175°C (-76 to +347°F)
AN 302-60	green	M 20 R 3/4"	700 - 1.000 mPa·s	0,15 mm	30 - 35 Nm 15 - 20 Nm*	55 - 70 Nm 30 - 35 Nm*	25 - 35 N/mm² (3.625 - 5.075 psi)	2 - 5 min. 5 - 10 min.*	2 - 4 h 6 - 12 h*	-60 to +180°C (-76 to +356°F)
AN 302-62	red	M 36	1.500 - 6.500 mPa·s	0,25 mm	20 - 25 Nm	40 - 55 Nm	10 - 15 N/mm² (1.450 - 2.175 psi)	10 - 20 min.	3 - 6 h	-60 to +150°C (-76 to +302°F)
AN 302-70	green	M 20 R 3/4"	500 mPa·s	0,15 mm	28 - 35 Nm	50 - 65 Nm	15 - 20 N/mm² (2.175 - 2.900 psi)	10 - 20 min.	3 - 6 h	-60 to +200°C (-76 to +392°F)
AN 302-71	red	M 20 R 3/4"	500 mPa·s	0,15 mm	28 - 35 Nm	50 - 65 Nm	15 - 20 N/mm² (2.175 - 2.900 psi)	10 - 20 min.	3 - 6 h	-60 to +150°C (-76 to +302°F)
AN 302-72	red	M 56 R 2"	6.000 - 15.000 mPa·s	0,30 mm	20 - 30 Nm	40 - 75 Nm	10 - 15 N/mm² (1.450 - 2.175 psi)	20 - 40 min.	5 - 10 h	-60 to +230°C (-76 to +446°F)
AN 302-90	green	M 5 capillary	10 - 20 mPa·s	0,07 mm	15 - 25 Nm	30 - 40 Nm	8 - 12 N/mm² (1.160 - 1.740 psi)	5 - 20 min.	approx. 3 h	-60 to +150°C (-76 to +302°F)

* Strength measured on V4A stainless steel screws



30 ml e
Art.-No. 30165150

Adhesives / Sealants

Technical Sprays

Technical Liquids

Assembly Pastes

Lubricants

WEICON TOOLS®

Other

AN 301-65



Pipe and flange sealing with PTFE | classified as non-hazardous | drinking water approval

- ▶ high viscosity
- ▶ medium strength
- ▶ disassembly with normal tools

- ▶ 50 ml 30165150
- ▶ 200 ml 30165200
- ▶ 300 ml 30165300



AN 301-65

AN 301-72



Pipe and flange sealing with PTFE | classified as non-hazardous | high-temperature-resistant | drinking water and DVGW approval

- ▶ higher viscosity
- ▶ medium strength
- ▶ disassembly with normal tools

- ▶ 50 ml 30172150
- ▶ 200 ml 30172200
- ▶ 300 ml 30172300



AN 302-25

Pipe and thread sealing | vibration-proof for coarse threads

- ▶ high viscosity
- ▶ low strength
- ▶ easy disassembly

- ▶ 50 ml 30225150
- ▶ 200 ml 30225200



AN 302-75

Pipe and thread sealing | BAM*

- ▶ high viscosity
- ▶ high strength
- ▶ hard to disassemble

- ▶ 50 ml 30275150
- ▶ 200 ml 30275200



AN 302-45



Pipe and thread sealing for coarse threads | DVGW approval

- ▶ high viscosity
- ▶ medium strength
- ▶ disassembly with normal tools

- ▶ 50 ml 30245150
- ▶ 200 ml 30245200



* according to leaflet M 031-1 "List of nonmetallic materials compatible with oxygen" (DGV information 213-078) of BG RCI

** **Passive materials:** (slow curing)

- ▶ high-alloyed steel
- ▶ aluminium, nickel, zinc, gold
- ▶ oxide layers
- ▶ chromate layers
- ▶ anodic coatings
- ▶ plastics and ceramics

WEICONLOCK® Pipe and Thread Sealing



AN 302-80



Pipe and thread sealing
for passive materials** |
drinking water approval

- ▶ higher viscosity
- ▶ high strength
- ▶ hard to disassemble



- ▶ 20 ml 30280020
- ▶ 50 ml 30280150
- ▶ 200 ml 30280200



AN 305-11



Pipe and thread sealing |
DVGW and drinking water approval

- ▶ higher viscosity
- ▶ medium strength
- ▶ disassembly with normal tools

- ▶ 50 ml 30511150
- ▶ 200 ml 30511200
- ▶ 300 ml 30511300



AN 302-77

Pipe and thread sealing for
large thread parts and flanges

- ▶ higher viscosity
- ▶ high strength
- ▶ hard to disassemble

- ▶ 50 ml 30277150
- ▶ 200 ml 30277200



SI 303-31



Nonfood Compounds
Program Listed S2
Registration 157190



Pipe and thread sealing |
ISEGA-certified | drinking water approval | NSF approval

- ▶ high viscosity
- ▶ low strength
- ▶ easy disassembly

- ▶ 85 ml
30331085
Tube

Tested by the Ruhr Region Institute of Hygiene ("Hygiene-Institut des Ruhrgebiets") according to the Guideline for Hygienic Assessment of Organic Materials in Contact with Drinking Water (KTW Guideline) by the Federal Environmental Agency of Germany.



Technical Data

Colour	For threaded joints up to	Gap filling capacity max.	Breakaway strength Nm (Thread)	Prevailing strength Nm (Thread)	Shear strength N/mm² (DIN 54452)	Handling strength at room temperature	Final strength at room temperature	Temperature resistance
white	M 80 R 3"	0,50 mm	< 1,5	< 0,5	< 1	24 h	3 days	-40 to +180°C



AN 305-86



* according to leaflet M 031-1 "List of non-metallic materials compatible with oxygen" (DGUV information 213-078) of BG RCI

- ** **Passive materials:** (slow curing)
- ▶ high-alloyed steel
 - ▶ aluminium, nickel, zinc, gold
 - ▶ oxide layers
 - ▶ chromate layers
 - ▶ anodic coatings
 - ▶ plastics and ceramics

AN 305-42



Hydraulic and pneumatic sealing | DVGW approval

- ▶ medium viscosity
- ▶ medium strength
- ▶ disassembly with normal tools

- ▶ 20 ml 30542020
- ▶ 50 ml 30542150
- ▶ 200 ml 30542200



VIDEO

AN 305-72



Pipe and flange sealing (with PTFE) | immediate sealing effect | drinking water and DVGW approval

- ▶ high viscosity
- ▶ medium strength
- ▶ disassembly with normal tools

- ▶ 50 ml 30572150
- ▶ 200 ml 30572200
- ▶ 300 ml 30572300



AN 305-67

Pipe and flange sealing with PTFE | gap filling capacity max. 0,60 mm

- ▶ high viscosity
- ▶ low strength
- ▶ easy disassembly

- ▶ 50 ml 30567150
- ▶ 200 ml 30567200
- ▶ 300 ml 30567300



AN 305-77



Thread sealing | drinking water and DVGW approval | BAM*

- ▶ high viscosity
- ▶ medium strength
- ▶ disassembly with normal tools

- ▶ 50 ml 30577150
- ▶ 200 ml 30577200
- ▶ 300 ml 30577300



Nonfood Compounds Program Listed S2 Registration 159910

WEICONLOCK® Pipe and Thread Sealing



Display
WEICONLOCK® 50 ml
30951191

AN 305-78



Pipe and thread sealing for
passive materials** | drinking
water and DVGW approval | BAM*

- ▶ high viscosity
- ▶ medium strength
- ▶ disassembly with normal tools

▶ 50 ml ▶ 200 ml
30578150 30578200



AN 305-86

Pipe sealing | extra strong

- ▶ higher viscosity
- ▶ high strength
- ▶ hard to disassemble

▶ 20 ml ▶ 50 ml ▶ 200 ml
30586020 30586150 30586200



Technical Data

Type-No.	Colour	For threaded joints up to	Viscosity at +25°C (+77°F) Brookfield	Gap filling capacity max.	Breakaway strength (Thread)	Prevailing strength (Thread)	Shear strength N/mm² (DIN 54452)	Handling strength at room temperature	Final strength at room temperature	Temperature resistance
AN 301-65	white	M 80 R 3"	180.000 - 300.000 mPa·s	0,50 mm	4 - 8 Nm	1 - 3 Nm	2 - 6 N/mm² (290 - 870 psi)	10 - 20 min.	24 h	-60 to +150°C (-76 to +302°F)
AN 301-72	white	M 80 R 3"	15.000 - 60.000 mPa·s	0,30 mm	5 - 10 Nm	4 - 6 Nm	5 - 7 N/mm² (725 - 1.015 psi)	15 - 30 min.	6 - 12 h	-60 to +200°C (-76 to +392°F)
AN 302-25	brown	M 80 R 3"	6.000 - 30.000 mPa·s	0,30 mm	5 - 8 Nm	2 - 4 Nm	3 - 5 N/mm² (435 - 725 psi)	15 - 30 min.	3 - 6 h	-60 to +150°C (-76 to +302°F)
AN 302-45	blue	M 80 R 3"	6.000 - 30.000 mPa·s	0,30 mm	10 - 15 Nm	12 - 18 Nm	8 - 12 N/mm² (1.160 - 1.740 psi)	15 - 30 min.	3 - 6 h	-60 to +150°C (-76 to +302°F)
AN 302-75	green	M 80 R 3"	14.000 - 24.000 mPa·s	0,30 mm	40 - 50 Nm	40 - 50 Nm	15 - 25 N/mm² (2.175 - 3.625 psi)	15 - 30 min.	3 - 6 h	-60 to +150°C (-76 to +302°F)
AN 302-77	red	M 36	6.000 mPa·s	0,25 mm	30 - 40 Nm	10 - 15 Nm	35 - 45 N/mm² (5.075 - 6.525 psi)	40 - 60 min.	6 - 12 h	-60 to +150°C (-76 to +302°F)
AN 302-80	green	M 36	3.000 - 6.000 mPa·s	0,20 mm	35 - 45 Nm 15 - 20 Nm*	50 - 70 Nm 25 - 35 Nm*	20 - 30 N/mm² (2.900 - 4.350 psi)	2 - 5 min. 5 - 10 min.*	2 - 4 h 6 - 12 h*	-60 to +200°C (-76 to +392°F)
AN 305-11	white	M 80 R 3"	17.000 - 50.000 mPa·s	0,40 mm	7 - 10 Nm	2 - 4 Nm	4 - 6 N/mm² (580 - 870 psi)	20 - 40 min.	5 - 10 h	-60 to +150°C (-76 to +302°F)
AN 305-42	brown	M 20 R 3/4"	500 mPa·s	0,15 mm	12 - 15 Nm	18 - 22 Nm	8 - 12 N/mm² (1.160 - 1.740 psi)	10 - 20 min.	2 - 4 h	-60 to +150°C (-76 to +302°F)
AN 305-67	white	M 80 R 3"	170.000 - 410.000 mPa·s	0,60 mm	3 - 5 Nm	2 - 4 Nm	6 - 8 N/mm² (870 - 1.160 psi)	120 - 240 min.	24 - 72 h	-50 to +175°C (-58 to +347°F)
AN 305-72	white	M 80 R 3"	17.000 - 50.000 mPa·s	0,40 mm	7 - 10 Nm	2 - 4 Nm	4 - 6 N/mm² (580 - 870 psi)	20 - 40 min.	5 - 10 h	-60 to +150°C (-76 to +302°F)
AN 305-77	yellow	M 80 R 3"	24.000 - 70.000 mPa·s	0,50 mm	18 - 22 Nm	10 - 14 Nm	6 - 13 N/mm² (870 - 1.885 psi)	15 - 30 min.	1 - 3 h	-60 to +150°C (-76 to +302°F)
AN 305-78	yellow	M 80 R 3"	50.000 - 80.000 mPa·s	0,50 mm	18 - 22 Nm 11 - 16 Nm*	10 - 14 Nm 4 - 7 Nm*	6 - 13 N/mm² (870 - 1.885 psi)	15 - 30 min. 25 - 50 min.*	1 - 3 h 4 - 8 h*	-60 to +150°C (-76 to +302°F)
AN 305-86	red	M 56 R 2"	6.000 - 7.000 mPa·s	0,30 mm	15 - 30 Nm	25 - 45 Nm	10 - 20 N/mm² (1.450 - 2.900 psi)	60 - 90 min.	12 - 24 h	-60 to +150°C (-76 to +302°F)

*Strength measured on V4A stainless steel screws

AN 301-38



Retaining cylindrical assemblies for bearings, shafts and bushings | drinking water approval

- ▶ medium viscosity
- ▶ high strength
- ▶ hard to disassemble

▶ 20 ml 30138020 ▶ 50 ml 30138150 ▶ 200 ml 30138200



AN 301-48



Retaining cylindrical assemblies for bearings, shafts and bushings | high-temperature-resistant | drinking water and DVGW approval

- ▶ medium viscosity
- ▶ high strength
- ▶ hard to disassemble

▶ 20 ml 30148020 ▶ 50 ml 30148150 ▶ 200 ml 30148200



AN 306-00



Retaining cylindrical assemblies for bearings, shafts and bushings

- ▶ medium viscosity
- ▶ high strength
- ▶ hard to disassemble

▶ 20 ml 30600020 ▶ 50 ml 30600150 ▶ 200 ml 30600200



AN 306-01

Retaining cylindrical assemblies for bearings | shafts and bushings

- ▶ low viscosity
- ▶ high strength
- ▶ hard to disassemble

▶ 20 ml 30601020 ▶ 50 ml 30601150 ▶ 200 ml 30601200



Retaining Cylindrical Assemblies

AN 306-03

Retaining cylindrical assemblies for bearings, shafts and bushings

- ▶ low viscosity
- ▶ high strength
- ▶ hard to disassemble

▶ 20 ml 30603020 ▶ 50 ml 30603150 ▶ 200 ml 30603200



AN 306-10

Retaining cylindrical assemblies for passive materials** | drinking water approval

- ▶ medium viscosity
- ▶ high strength
- ▶ hard to disassemble

▶ 20 ml 30610020 ▶ 50 ml 30610150 ▶ 200 ml 30610200



AN 306-20

Retaining cylindrical assemblies | high-temperature-resistant | drinking water and DVGW approval | BAM*

- ▶ higher viscosity
- ▶ high strength
- ▶ hard to disassemble

▶ 20 ml 30620020 ▶ 50 ml 30620150 ▶ 200 ml 30620200



Display WEICONLOCK® 20 ml

12951091



AN 306-30

Retaining cylindrical assemblies for passive materials** | BAM* | drinking water approval

- ▶ higher viscosity
- ▶ high strength
- ▶ hard to disassemble

▶ 20 ml 30630020 ▶ 50 ml 30630150 ▶ 200 ml 30630200



VIDEO

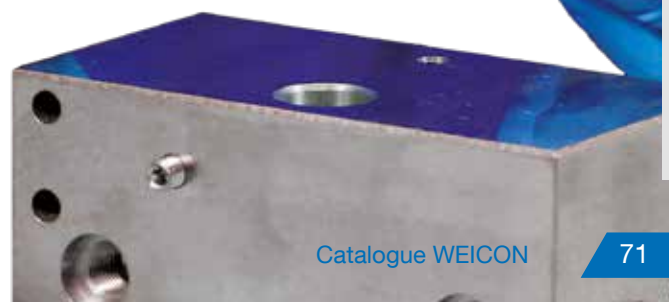

* according to leaflet M 031-1 "List of non-metallic materials compatible with oxygen" (DGUV information 213-078) of BG RCI

** Passive materials: (slow curing)

- ▶ high-alloyed steel
- ▶ aluminium, nickel, zinc, gold
- ▶ oxide layers
- ▶ chromate layers
- ▶ anodic coatings
- ▶ plastics and ceramics



Display
WEICONLOCK® PEN
50,5 cm x 221cm
30951080



Adhesives / Sealants

Technical Sprays

Technical Liquids

Assembly Pastes

Lubricants

WEICON TOOLS®

Other

AN 306-38



Retaining cylindrical assemblies for bearings, gear wheels and bolts | fast cure | drinking water approval

- ▶ medium viscosity
- ▶ high strength
- ▶ hard to disassemble



- ▶ 10 ml 30638110
- ▶ 20 ml 30638020
- ▶ 50 ml 30638150
- ▶ 200 ml 30638200

AN 306-40

Retaining cylindrical assemblies | high-temperature-resistant | slow cure

- ▶ medium viscosity
- ▶ high strength
- ▶ hard to disassemble



- ▶ 20 ml 30640020
- ▶ 50 ml 30640150
- ▶ 200 ml 30640200

AN 306-41

Retaining cylindrical assemblies for bearings, shafts and bushings

- ▶ medium viscosity
- ▶ medium strength
- ▶ disassembly with normal tools



- ▶ 20 ml 30641020
- ▶ 50 ml 30641150
- ▶ 200 ml 30641200



Retaining Cylindrical Assemblies

AN 306-60
Assembly of cylindrical parts for worn out bearing rings and bushings

- ▶ high viscosity
- ▶ high strength
- ▶ hard to disassemble

- ▶ 50 ml ▶ 200 ml ▶ 300 ml
- 30660150 30660200 30660300

AN 306-48

Retaining cylindrical assemblies | high-temperature-resistant | drinking water approval | BAM*

- ▶ medium viscosity
- ▶ high strength
- ▶ hard to disassemble

- ▶ 20 ml ▶ 50 ml ▶ 200 ml
- 30648020 30648150 30648200



* according to leaflet M 031-1 "List of non-metallic materials compatible with oxygen" (DGUV information 213-078) of BG RCI

Technical Data

Type-No.	Colour	For threaded joints up to	Viscosity at +25°C (+77°F) Brookfield	Gap filling capacity max.	Breakaway strength (Thread)	Prevailing strength (Thread)	Shear strength N/mm² (DIN 54452)	Handling strength at room temperature	Final strength at room temperature	Temperature resistance
AN 301-38	green	M 36	2.000 - 3.000 mPa·s	0,20 mm	30 - 40 Nm	45 - 60 Nm	20 - 25 N/mm² (2.900 - 3.625 psi)	approx. 5 min.	2 - 4 h	-60 to +150°C (-76 to +302°F)
AN 301-48	green	M 20 R 3/4"	450 - 650 mPa·s	0,15 mm	25 - 30 Nm	40 - 55 Nm	25 - 30 N/mm² (3.625 - 4.350 psi)	2 - 6 min.	2 - 4 h	-60 to +175°C (-76 to +347°F)
AN 306-00	transparent	M 20 R 3/4"	500 mPa·s	0,15 mm	30 - 35 Nm	55 - 70 Nm	25 - 35 N/mm² (3.625 - 5.075 psi)	2 - 5 min.	2 - 4 h	-60 to +175°C (-76 to +347°F)
AN 306-01	green	M 12	125 mPa·s	0,10 mm	25 - 30 Nm	50 - 60 Nm	14 - 20 N/mm² (2.030 - 2.900 psi)	10 - 20 min.	2 - 4 h	-60 to +150°C (-76 to +302°F)
AN 306-03	green	M 12	125 mPa·s	0,10 mm	25 - 30 Nm	50 - 60 Nm	15 - 18 N/mm² (2.175 - 2.610 psi)	10 - 20 min.	2 - 4 h	-60 to +150°C (-76 to +302°F)
AN 306-10	green	M 20 R 3/4"	700 - 1.000 mPa·s	0,15 mm	30 - 35 Nm	55 - 70 Nm	25 - 35 N/mm² (3.625 - 5.075 psi)	2 - 5 min.	2 - 4 h	-60 to +200°C (-76 to +392°F)
					15 - 20 Nm*	30 - 35 Nm*		5 - 10 min.*	6 - 12 h*	
AN 306-20	green	M 56 R 2"	3.000 - 6.000 mPa·s	0,20 mm	28 - 36 Nm	40 - 55 Nm	15 - 25 N/mm² (2.175 - 3.625 psi)	20 - 40 min.	approx. 24 h	-60 to +200°C (-76 to +392°F)
AN 306-30	green	M 36	3.000 - 6.000 mPa·s	0,20 mm	35 - 45 Nm	50 - 70 Nm	20 - 30 N/mm² (2.900 - 4.350 psi)	2 - 5 min.	2 - 4 h	-60 to +200°C (-76 to +392°F)
					15 - 20 Nm*	25 - 35 Nm*		5 - 10 min.*	2 - 4 h*	
AN 306-38	green	M 36	2.500 mPa·s	0,20 mm	35 - 45 Nm	50 - 70 Nm	25 - 30 N/mm² (3.625 - 4.350 psi)	approx. 5 min.	1 - 3 h	-60 to +150°C (-76 to +302°F)
AN 306-40	green	M 20	600 mPa·s	0,15 mm	20 - 30 Nm	30 - 40 Nm	15 - 30 N/mm² (2.175 - 4.350 psi)	approx. 240 min.	approx. 24 h	-60 to +200°C (-76 to +392°F)
AN 306-41	yellow	M 20	550 mPa·s	0,12 mm	12 - 15 Nm	17 - 22 Nm	8 - 12 N/mm² (1.160 - 1.740 psi)	10 - 20 min.	3 - 6 h	-60 to +150°C (-76 to +302°F)
AN 306-48	green	M 20	550 mPa·s	0,15 mm	30 - 35 Nm	55 - 70 Nm	25 - 35 N/mm² (3.625 - 5.075 psi)	approx. 5 min.	2 - 4 h	-60 to +175°C (-76 to +347°F)
AN 306-60	silver	R 2"	150.000 - 900.000 mPa·s	0,50 mm	35 - 45 Nm	10 - 20 Nm	25 - 30 N/mm² (3.625 - 4.350 psi)	15 - 30 min.	3 - 6 h	-60 to +150°C (-76 to +302°F)

*Strength measured on V4A stainless steel screws



AN 301-65



Pipe and flange sealing with PTFE | classified as non-hazardous | drinking water approval

- ▶ high viscosity
- ▶ medium strength
- ▶ disassembly with normal tools

▶ 50 ml 30165150 ▶ 200 ml 30165200 ▶ 300 ml 30165300



AN 301-72



Pipe and flange sealing with PTFE | classified as non-hazardous | high-temperature-resistant | drinking water and DVGW approval

- ▶ higher viscosity
- ▶ medium strength
- ▶ disassembly with normal tools

▶ 50 ml 30172150 ▶ 200 ml 30172200 ▶ 300 ml 30172300



AN 305-10



Gasketing of flanges | high-temperature-resistant | BAM*

- ▶ high viscosity
- ▶ high strength
- ▶ hard to disassemble

▶ 50 ml 30510150 ▶ 200 ml 30510200 ▶ 300 ml 30510300



AN 305-18

Flange sealing for filling large gaps immediate sealing effect | high-temperature-resistant

- ▶ high viscosity
- ▶ high strength
- ▶ hard to disassemble

▶ 50 ml 30518150 ▶ 200 ml 30518200 ▶ 300 ml 30518300



AN 305-67

Pipe and flange sealing with PTFE | gap filling capacity max. 0,60 mm

- ▶ high viscosity
- ▶ low strength
- ▶ easy disassembly

▶ 50 ml 30567150 ▶ 200 ml 30567200



* according to leaflet M 031-1 "List of non-metallic materials compatible with oxygen" (DGV information 213-078) of BG RCI

Flange Sealing and Gasketing

Adhesives / Sealants

Technical Sprays

Technical Liquids

Assembly Pastes

Lubricants

WEICON TOOLS®

Other

AN 305-72



Pipe and flange sealing with PTFE | immediate sealing effect | drinking water and DVGW approval

- ▶ high viscosity
- ▶ medium strength
- ▶ disassembly with normal tools

- ▶ 50 ml 30572150
- ▶ 200 ml 30572200
- ▶ 300 ml 30572300



AN 305-73

Gasketing of flanges, gearboxes and other motor housings

- ▶ high viscosity
- ▶ low strength
- ▶ easy disassembly

- ▶ 50 ml 30573150
- ▶ 200 ml 30573200
- ▶ 300 ml 30573300



AN 305-74

Gasketing of flanges, gearboxes and other motor housings

- ▶ high viscosity
- ▶ high strength
- ▶ hard to disassemble

- ▶ 50 ml 30574150
- ▶ 200 ml 30574200
- ▶ 300 ml 30574300



Technical data

Type-No.	Colour	For threaded joints up to	Viscosity at +25°C (+77°F) Brookfield	Gap filling capacity max.	Breakaway strength (Thread)	Prevailing strength (Thread)	Shear strength N/mm² (DIN 54452)	Handling strength at room temperature	Final strength at room temperature	Temperature resistance
AN 301-65	white	M 80 R 3"	180.000 - 300.000 mPa·s	0,50 mm	4 - 8 Nm	1 - 3 Nm	2 - 6 N/mm² (290 - 870 psi)	10 - 20 min.	24 h	-60 to +150°C (-76 to +302°F)
AN 301-72	white	M 80 R 3"	15.000 - 60.000 mPa·s	0,30 mm	5 - 10 Nm	4 - 6 Nm	5 - 7 N/mm² (725 - 1.015 psi)	15 - 30 min.	6 - 12 h	-60 to +200°C (-76 to +392°F)
AN 305-10	orange	---	70.000 - 300.000 mPa·s	0,50 mm	18 - 25 Nm	15 - 25 Nm	5 - 10 N/mm² (725 - 1.450 psi)	15 - 30 min.	6 - 12 h	-60 to +200°C (-76 to +392°F)
AN 305-18	red	---	80.000 - 500.000 mPa·s	0,50 mm	12 - 18 Nm	18 - 24 Nm	8 - 13 N/mm² (1.160 - 1.885 psi)	10 - 20 min.	3 - 6 h	-60 to +200°C (-76 to +392°F)
AN 305-67	white	M 80 R 3"	170.000 - 410.000 mPa·s	0,60 mm	3 - 5 Nm	2 - 4 Nm	6 - 8 N/mm² (870 - 1.160 psi)	120 - 240 min.	24 - 72 h	-50 to +175°C (-58 to +347°F)
AN 305-72	white	M 80 R 3"	17.000 - 50.000 mPa·s	0,40 mm	7 - 10 Nm	2 - 4 Nm	4 - 6 N/mm² (580 - 870 psi)	20 - 40 min.	5 - 10 h	-60 to +150°C (-76 to +302°F)
AN 305-73	light green	---	17.000 - 50.000 mPa·s	0,30 mm	6 - 10 Nm	2 - 5 Nm	4 - 6 N/mm² (580 - 870 psi)	20 - 40 min.	approx. 12 h	-60 to +150°C (-76 to +302°F)
AN 305-74	orange	---	30.000 - 100.000 mPa·s	0,50 mm	16 - 24 Nm	5 - 10 Nm	5 - 10 N/mm² (725 - 1.450 psi)	15 - 30 min.	approx. 12 h	-60 to +180°C (-76 to +356°F)

Type-No.	Application	Features	Colour	For threaded joints up to	Viscosity in mPa.s at +25°C (67°F) Brookfield	Gap filling capacity in mm max.	Breakaway strength N/m (Thread ¹)	Prevailing strength N/m (Thread ¹)	Shear strength** N/mm ² (DIN 54452)	Handling strength at room temp. (minute)	Final strength at room temperature (hours)	Temperature resistance
AN 301-43 NSF	Threadlocking, drinking water and DVGW ² approval	medium strength higher viscosity	blue	M 36	2.000 - 8.000 mt	0,25	18 - 22	9 - 11	10 - 13 (1.450 - 2.900 psi)	5 - 15	1 - 3	-60°C to +150°C (-76°F to +302°F)
AN 301-70 NSF	Threadlocking, drinking water approval	high strength medium viscosity	green	M 25	500 - 900 nt	0,15	25 - 35	40 - 50	14 - 20 (2.030 - 2.900 psi)	5 - 15	5 - 10	-60°C to +150°C (-76°F to +302°F)
AN 302-21	Threadlocking	low strength low viscosity	violet	M 12	125	0,10	7 - 10	3 - 6	4 - 7 (580 - 1.015 psi)	10 - 20	3 - 6	-60°C to +150°C (-76°F to +302°F)
AN 302-22	Threadlocking	low strength medium viscosity	purple	M 36	1.000 mt	0,20	4 - 8	2 - 4	3 - 5 (435 - 725 psi)	10 - 20	3 - 6	-60°C to +150°C (-76°F to +302°F)
AN 302-40	Threadlocking, DVGW ² approval	medium strength medium viscosity	transparent	M 20 R ¾"	600 nt	0,15	12 - 16	18 - 24	8 - 12 (1.160 - 1.740 psi)	10 - 20	3 - 6	-60°C to +150°C (-76°F to +302°F)
AN 302-41	Threadlocking	medium strength low viscosity	blue	M 12	125 nt	0,10	10 - 15	12 - 16	8 - 12 (1.160 - 1.740 psi)	10 - 20	approx. 3	-60°C to +150°C (-76°F to +302°F)
AN 302-42	Threadlocking, drinking water approval	medium strength medium viscosity	blue	M 36	1.000 mt	0,20	14 - 18	5 - 8	8 - 12 (1.160 - 1.740 psi)	10 - 20	3 - 6	-60°C to +150°C (-76°F to +302°F)
AN 302-43	Threadlocking, drinking water and DVGW ² approval	medium strength higher viscosity	blue	M 36	2.000 - 7.000 mt	0,25	17 - 22	8 - 12	9 - 13 (1.305 - 1.885 psi)	10 - 20	1 - 3	-60°C to +200°C (-76°F to +392°F)
AN 302-44	Threadlocking for passive materials, drinking water and DVGW ² approval	medium strength higher viscosity	blue	M 36	3.000 - 8.000 mt	0,25	17 - 22	8 - 12	9 - 13 (1.305 - 1.885 psi)	10 - 20	1 - 3	-60°C to +200°C (-76°F to +392°F)
							8 - 12 ²	5 - 8 ²		20 - 40 ²	4 - 8 ²	
AN 302-50	Threadlocking	high strength medium viscosity	transparent	M 20 R ¾"	500 nt	0,15	30 - 35	55 - 70	25 - 35 (3.625 - 5.075 psi)	2 - 5	2 - 4	-60°C to +175°C (-76°F to +347°F)
AN 302-60	Threadlocking for passive materials	high strength medium viscosity	green	M 20 R ¾"	700 - 1.000 nt	0,15	30 - 35	55 - 70	25 - 35 (3.625 - 5.075 psi)	2 - 5	2 - 4	-60°C to +200°C (-76°F to +392°F)
							15 - 20 ²	30 - 35 ²		5 - 10 ²	6 - 12 ²	
AN 302-62	Threadlocking	strong higher viscosity	red	M 36	1.500 - 6.500 mt	0,25	20 - 25	40 - 55	10 - 15 (1.450 - 2.175 psi)	10 - 20	3 - 6	-60°C to +150°C (-76°F to +302°F)
AN 302-70	Locking of threads and stud bolts, drinking water and DVGW ² approval	high strength medium viscosity	green	M 20 R ¾"	500 nt	0,15	28 - 35	50 - 65	15 - 20 (2.175 - 2.900 psi)	10 - 20	3 - 6	-60°C to +200°C (-76°F to +392°F)
AN 302-71	Locking of threads and stud bolts	high strength medium viscosity	red	M 20 R ¾"	500 nt	0,15	28 - 35	50 - 65	15 - 20 (2.175 - 2.900 psi)	10 - 20	3 - 6	-60°C to +150°C (-76°F to +302°F)
AN 302-72	Locking of threads and stud bolts, drinking water and DVGW ² approval	high strength higher viscosity	red	M 56 R 2"	6.000 - 15.000 mt	0,30	20 - 30	40 - 75	10 - 15 (1.450 - 2.175 psi)	20 - 40	5 - 10	-60°C to +230°C (-76°F to +446°F)
AN 302-90	Threadlocking for locking after assembly	high strength extremely low viscosity	green	M 5 kapillar	10 - 20	0,07	15 - 25	30 - 40	8 - 12 (1.160 - 1.740 psi)	5 - 20	approx. 3	-60°C to +150°C (-76°F to +302°F)

AN 301-65 NSF	Pipe and flange sealing (with PTFE), drinking water approval	medium strength, high viscosity	white	M 80 R 3"	180.000 - 300.000	0,50	4 - 8	1 - 3	2 - 6 (290 - 870 psi)	10 - 20	24	-60°C to +150°C (-76°F to +302°F)
AN 301-72 NSF	Pipe and flange sealing (with PTFE), drinking water and DVGW ² approval	medium strength, high viscosity	white	M 80 R 3"	15.000 - 60.000 ht	0,30	5 - 10	4 - 6	5 - 7 (725 - 1.015 psi)	15 - 30	6 - 12	-60°C to +200°C (-76°F to +392°F)
AN 302-25	Sealing of threaded pipes and fittings	low strength, high viscosity	brown	M 80 R 3"	6.000 - 30.000 mt	0,30	5 - 8	2 - 4	3 - 5 (435 - 725 psi)	15 - 30	3 - 6	-60°C to +150°C (-76°F to +302°F)
AN 302-45	Sealing of threaded pipes and fittings, DVGW ² -approval	medium strength, high viscosity	blue	M 80 R 3"	6.000 - 30.000 mt	0,30	10 - 15	12 - 18	8 - 12 (1.160 - 1.740 psi)	15 - 30	3 - 6	-60°C to +150°C (-76°F to +302°F)
AN 302-75	Sealing of threaded pipes and fittings, BAM ³	high strength, high viscosity	green	M 80 R 3"	14.000 - 24.000 mt	0,30	40 - 50	40 - 50	15 - 25 (2.175 - 3.625 psi)	15 - 30	3 - 6	-60°C to +150°C (-76°F to +302°F)
AN 302-77	Sealing of threaded pipes and fittings	high strength, higher viscosity	red	M 36	6.000	0,25	30 - 40	10 - 15	35 - 45 (5.075 - 6.525 psi)	40 - 60	6 - 12	-60°C to +150°C (-76°F to +302°F)
AN 302-80	Sealing of threaded pipes and fittings for passive materials	high strength, higher viscosity	green	M 36	3.000 - 6.000 mt	0,20	35 - 45	50 - 70	20 - 30 (2.900 - 4.350 psi)	2 - 5	2 - 4	-60°C to +200°C (-76°F to +392°F)
							15 - 20 ²	25 - 35 ²		5 - 10 ²	6 - 12 ²	
AN 305-11	Sealing of threaded pipes and fittings, drinking water and DVGW ² approval	medium strength, high viscosity	white	M 80 R 3"	17.000 - 50.000 ht	0,40	7 - 10	2 - 4	4 - 6 (580 - 870 psi)	20 - 40	5 - 10	-60°C to +150°C (-76°F to +302°F)
AN 305-42	Sealant for hydraulic and pneumatic systems, DVGW ² approval	medium strength, medium viscosity	brown	M 20 R ¾"	500 nt	0,15	12 - 15	18 - 22	8 - 12 (1.160 - 1.740 psi)	10 - 20	2 - 4	-60°C to +150°C (-76°F to +302°F)
AN 305-67	Pipe and flange sealing (with PTFE)	low strength, high viscosity	white	M 80 R 3"	170.000 - 410.000	0,60	3 - 5	2 - 4	6 - 8 (870 - 1.160 psi)	120 - 240	24 - 72	-50°C to +175°C (-58°F to +347°F)
AN 305-72	Pipe and flange sealing (with PTFE), drinking water, DVGW ² and AGA ⁴⁴ approval	medium strength, high viscosity	white	M 80 R 3"	17.000 - 50.000 ht	0,40	7 - 10	2 - 4	4 - 6 (580 - 870 psi)	20 - 40	5 - 10	-60°C to +150°C (-76°F to +302°F)
AN 305-77 NSF	Sealing of threaded pipes and fittings, BAM ³ , drinking water, DVGW ² and AGA ⁴⁴ approval	medium strength, high viscosity	yellow	M 80 R 3"	24.000 - 70.000 ht	0,50	18 - 22	10 - 14	6 - 13 (870 - 1.885 psi)	15 - 30	1 - 3	-60°C to +150°C (-76°F to +302°F)
AN 305-78	Sealing of threaded pipes and fittings for passive materials, drinking water and DVGW ² approval	medium strength, high viscosity	yellow	M 80 R 3"	50.000 - 80.000 ht	0,50	18 - 22	10 - 14	6 - 13 (870 - 1.885 psi)	15 - 30	1 - 3	-60°C to +150°C (-76°F to +302°F)
							11 - 16 ²	4 - 7 ²		25 - 50 ²	4 - 8 ²	
AN 305-86	Pipe sealing (extra strong)	high strength, higher viscosity	red	M 56 R 2"	6.000 - 7.000 nt	0,30	15 - 30	25 - 45	10 - 20 (1.450 - 2.900 psi)	60 - 90	12 - 24	-60°C to +150°C (-76°F to +302°F)

Type-No.	Application	Features	Colour	For threaded joints up to	Viscosity in mPa.s at +25°C (+77°F) Brookfield	Gap filling capacity in mm max.	Breakaway strength N/m (Thread ¹)	Prevailing strength N/m (Thread ¹)	Shear strength** N/mm ² (DIN 54452)	Handling strength at room temp. (minute)	Final strength at room temperature (hours)	Temperature resistance
AN 301-38 NSF	Retaining cylindrical assemblies, drinking water approval	high strength, medium viscosity	green	M 36	2.000 - 3.000 mt	0,20	30 - 40	45 - 60	20 - 25 (2.900 - 3.625 psi)	approx. 5	2 - 4	-60°C to +150°C (-76°F to +302°F)
AN 301-48 NSF	Retaining cylindrical assemblies, drinking water and DVGW ² approval	high strength, medium viscosity	green	M 20 R ¾"	450 - 650 nt	0,15	25 - 30	40 - 55	25 - 30 (3.625 - 4.350 psi)	2 - 6	2 - 4	-60°C to +175°C (-76°F to +347°F)
AN 306-00	Retaining cylindrical assemblies	high strength, medium viscosity	transparent	M 20 R ¾"	500 nt	0,15	30 - 35	55 - 70	25 - 35 (3.625 - 5.075 psi)	2 - 5	2 - 4	-60°C to +175°C (-76°F to +347°F)
AN 306-01	Retaining cylindrical assemblies	high strength, low viscosity	green	M 12	125 nt	0,10	25 - 30	50 - 60	18 - 23 (2.610 - 3.335 psi)	10 - 20	2 - 4	-60°C to +150°C (-76°F to +302°F)
AN 306-03	Retaining cylindrical assemblies	high strength, low viscosity	green	M 12	125 nt	0,10	25 - 30	50 - 60	15 - 18 (2.175 - 2.610 psi)	10 - 20	2 - 4	-60°C to +150°C (-76°F to +302°F)
AN 306-10	Retaining cylindrical assemblies for passive materials, drinking water approval	high strength, medium viscosity	green	M 20 R ¾"	700 - 1.000 nt	0,15	30 - 35 15 - 20 ²	55 - 70 30 - 35 ²	25 - 35 (3.625 - 5.075 psi)	2 - 5 5 - 10 ²	2 - 4 6 - 12 ²	-60°C to +200°C (-76°F to +392°F)
AN 306-20	Retaining cylindrical assemblies, drinking water and DVGW ² approval, BAM ³	high strength, higher viscosity	green	M 56 R 2"	3.000 - 6.000 nt	0,20	28 - 36	40 - 55	15 - 25 (2.175 - 3.625 psi)	20 - 40	approx. 24	-60°C to +200°C (-76°F to +392°F)
AN 306-30	Retaining cylindrical assemblies for passive materials, BAM ³	high strength, higher viscosity	green	M 36	3.000 - 6.000 mt	0,20	35 - 45 15 - 20 ²	50 - 70 25 - 35 ²	20 - 30 (2.900 - 4.350 psi)	2 - 5 5 - 10 ²	2 - 4 6 - 12 ²	-60°C to +200°C (-76°F to +392°F)
AN 306-38	Retaining cylindrical assemblies, drinking water approval	high strength, medium viscosity	green	M 36	2.500 mt	0,20	35 - 45	50 - 70	25 - 30 (3.625 - 4.350 psi)	approx. 5	1 - 3	-60°C to +150°C (-76°F to +302°F)
AN 306-40	Retaining cylindrical assemblies	high strength, medium viscosity	green	M 20	600 nt	0,15	20 - 30	30 - 40	15 - 30 (2.175 - 4.350 psi)	approx. 240	approx. 24	-60°C to +200°C (-76°F to +392°F)
AN 306-41	Retaining cylindrical assemblies	medium strength, medium viscosity	yellow	M 20	550 nt	0,12	12 - 15	17 - 22	8 - 12 (1.160 - 1.740 psi)	10 - 20	3 - 6	-60°C to +150°C (-76°F to +302°F)
AN 306-48	Retaining cylindrical assemblies, drinking water approval, BAM ³	high strength, medium viscosity	green	M 20	550 nt	0,15	30 - 35	55 - 70	25 - 35 (3.625 - 5.075 psi)	approx. 5	2 - 4	-60°C to +175°C (-76°F to +347°F)
AN 306-60	Assembly of cylindrical parts	high strength, high viscosity	silver	R 2"	150.000 - 900.000 ht	0,50	35 - 45	10 - 20	25 - 30 (3.625 - 4.350 psi)	15 - 30	3 - 6	-60°C to +150°C (-76°F to +302°F)
AN 301-65 NSF	Pipe and flange sealing (with PTFE), drinking water approval	medium strength, high viscosity	white	M 80 R 3"	180.000 - 300.000	0,50	4 - 8	1 - 3	2 - 6 (290 - 870 psi)	10 - 20	24	-60°C to +150°C (-76°F to +302°F)
AN 301-72 NSF	Pipe and flange sealing (with PTFE), drinking water and DVGW ² approval	medium strength, high viscosity	white	M 80 R 3"	15.000 - 60.000 ht	0,30	5 - 10	4 - 6	5 - 7 (725 - 1.015 psi)	15 - 30	6 - 12	-60°C to +200°C (-76°F to +392°F)
AN 305-10	Flange sealing, AGA ⁴ -approval, BAM ³	high strength, high viscosity	orange	---	70.000 - 300.000 ht	0,50	18 - 25	15 - 25	5 - 10 (725 - 1.450 psi)	15 - 30	6 - 12	-60°C to +200°C (-76°F to +392°F)
AN 305-18	Flange sealing	high strength, high viscosity	red	---	80.000 - 500.000 ht	0,50	12 - 18	18 - 24	8 - 13 (1.160 - 1.885 psi)	10 - 20	3 - 6	-60°C to +200°C (-76°F to +392°F)
AN 305-67	Pipe and flange sealing (with PTFE)	low strength, high viscosity	white	M 80 R 3"	170.000 - 410.000	0,60	3 - 5	2 - 4	6 - 8 (1.160 - 1.740 psi)	120 - 240	24 - 72	-50°C to +175°C (-58°F to +347°F)
AN 305-72	Pipe and flange sealing (with PTFE), drinking water, DVGW ² AGA ⁴ -approval	medium strength, high viscosity	white	M 80 R 3"	17.000 - 50.000 ht	0,40	7 - 10	2 - 4	4 - 6 (580 - 870 psi)	20 - 40	5 - 10	-60°C to +150°C (-76°F to +302°F)
AN 305-73	Flange sealing	low strength, high viscosity	light green	---	17.000 - 50.000 ht	0,30	6 - 10	2 - 5	4 - 6 (580 - 870 psi)	20 - 40	approx. 12	-60°C to +150°C (-76°F to +302°F)
AN 305-74	Flange sealing	high strength, high viscosity	orange	---	30.000 - 100.000 ht	0,50	16 - 24	5 - 10	5 - 10 (725 - 1.450 psi)	15 - 30	approx. 12	-60°C to +180°C (-76°F to +356°F)

*Strength values based on M 10 screws, 8.8 grade, thickness of nut 0,8 d

**Strength measured on V4A stainless steel screws

***Static shear strength based on cylindrical parts of abt. Ø 13 mm, tolerance (D-d) = 0,05 mm, l/d = 0,88

² DVGW Certificate for use in gas supply and hot water systems

³ BAM tested and safety-related evaluated- according to leaflet M 031-1

⁴ "List of nonmetallic materials compatible with oxygen" (DGU information 213-078) of BG RCI

⁴ Australian Gas Association - Approval - Gas Class II 500 kPa

We do not recommend WEICONLOCK for long-term use on connections of copper and its alloys if exposed to water of more than +40°C (+104°F).

All recommendations and technical data are based on laboratory tests and extensive experiences by users. They have been compiled with greatest care but we take no warranty of any kind and accept no liability for the results obtained.

* nt = low thixotrope
mt = medium thixotrope
ht = high thixotrope





Chemical resistance of WEICONLOCK*

Medium	Resistance
Waste water, excrements	+
Aluminium chloride	+
Apple juice, apple wine	+
Aromat, Solvent	+
Ethanol	+
Acetone	+
Benzol	+
Petrol	+
Beer	+
Wort, malt extract	+
Brake fluid	+
Butyl alcohol	+
Butyl acetate	+
Chlorine alcohol	+
Chlorinated water	+
Vinegar	+
Acetic acid 10%	%
Acetic acid 80%	o
Ethyl acetate	+
Formaldehyde - cold	+
Formaldehyde - hot	o
Glycol, glycine	+
Glycolic acid	+
Fuel oil	+
Heptane	+
Hexane	+
Isobutyl alcohol	+
Potassium chromate	+
Potassium carbonate	+
Calcium chlorate	+
Calcium chloride	+
Calcium hydroxide	+
Calcium phosphate	+
Calcium sulfate	+
Kerosene	+
Methanol, methyl alcohol	+

Methylethylheton	+
Mineral oil	+
Naphtha, petroleum	+
Sodium chlorite	+
Sodium fluoride	+
Bio-Diesel (RME)	+
Diesel, heating oil	+
Ozone, liquid	-
Phenol	+
Seawater	+
Silicone oil	+
Edible oil	+
Turpentine	+
Toluene, methylbenzene	+
Grape juice	+
Water (acidic) under PH 7	+
Water PH 7 to 8	+
Water (alk.) over PH 8	+
Water cooked	o
Water distilled	+
Hydrogen	+
Hydrogen peroxide	+
Xylene, dimethylbenzene	+
Cylinder oil	+

Gas	Resistance
Acetylene	+
Ammonia, ammonium chloride	+
Hydrochloric acid	+
Helium	+
Isobutane	+
Methyl chloride	+
Natural gas - dry	+
Ozone	-
Propane	+
Oxygen, (only WEICONLOCK-Types with BAM)	+
Sulphur dioxide	+
Nitrogen gas	+

+ = good resistance o = resistant
% = limited resistance - = not resistant

The a.m. resistances are a short excerpt.
Further chemical resistances are available upon request.

*Does not apply to SI 303-31

Adhesives / Sealants
 Technical Sprays
 Technical Liquids
 Assembly Pastes
 Lubricants
 WEICON TOOLS®
 Other

WEICONLOCK®

Strength of WEICONLOCK® dependent on the roughness

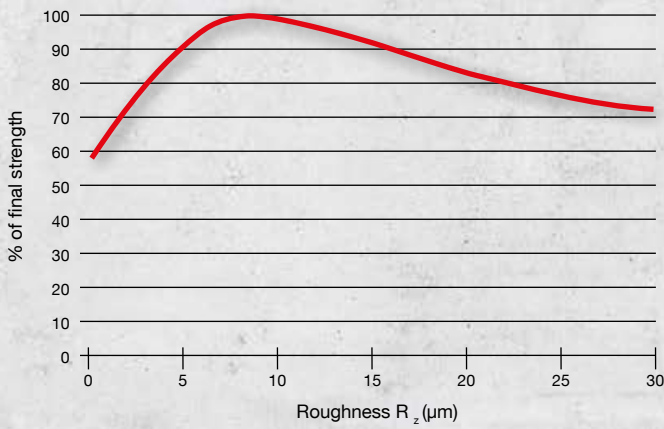

Curing speed of WEICONLOCK® dependent on the ambient temperature

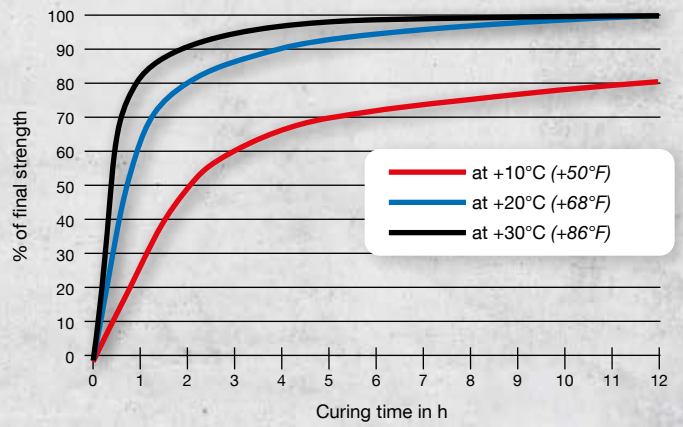

Strength of WEICONLOCK® dependent on the joint gap

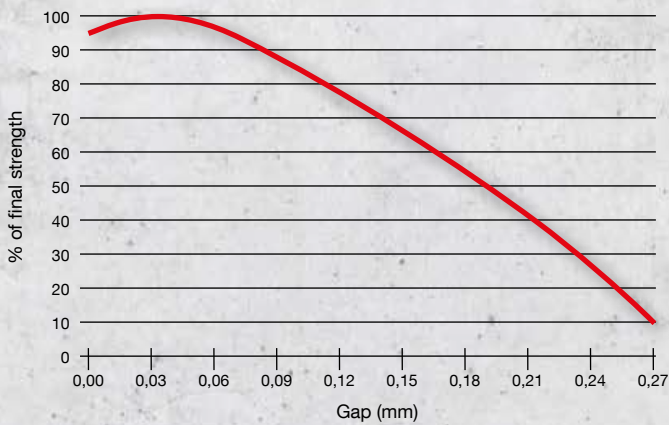

Temperature long-term resistance WEICONLOCK® at increased temperatures

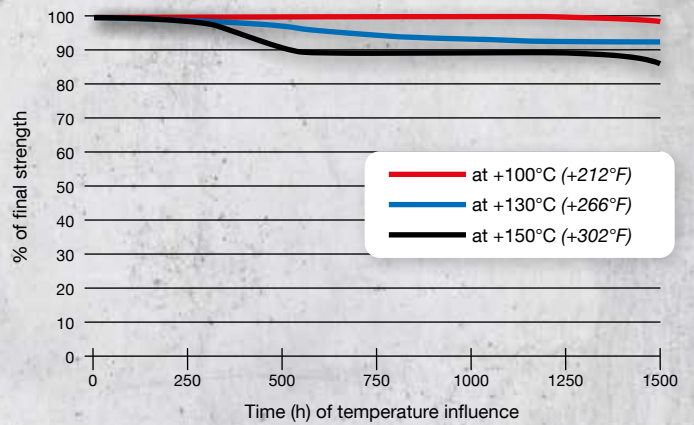

Curing speed with WEICON Activator F

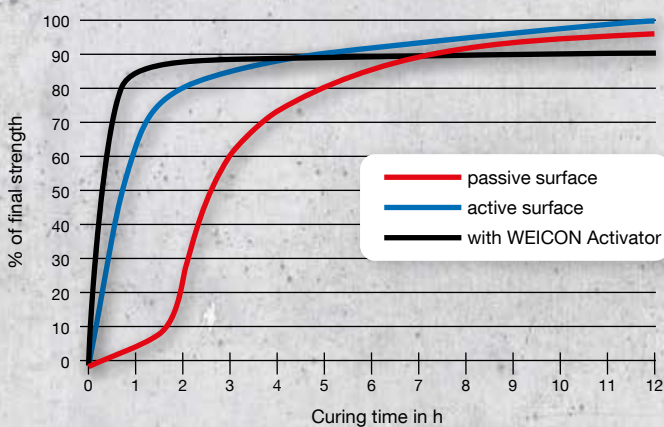

Gasket Maker

Permanently elastic special sealant

WEICON Gasket Maker is a strong and permanently elastic special sealant that cures with air humidity and practically without shrinkage. Gasket Maker has a very good adhesion to steel, aluminium, glass, ceramic, and many other materials.

Gasket Maker has an excellent temperature, oil and grease resistance, is pressure- and ageing-resistant, UV-stable and permanently elastic.

The special sealant can be used on engines and water pumps, gears and axles, oil sumps and in many other applications.

- ▶ 310 ml ▶ 310 ml
- 30100310** **30101310**
- red black



Technical data

	WEICON Gasket Maker in non-cured condition	
	red	black
Basis:	One-component acetate	
Density (g/cm ³):	1,28	1,06
Viscosity:	pasty	
Stability/Run-off (ASTM D 2202) mm:	1	>1
Cure type:	by humidity	
Curing condition:	+5°C to +35°C (+41 to +95°F) and 30% to 95% rel. humidity	
Skin-over time (minutes):* ³	12	7
Cure speed:* ³	2-3 mm in the first 24 hours	
Volume change (DIN 52451) %:* ³	-1 %	-3 %
Gap filling up to max. mm:	5	
Gap width up to max. mm:	25	
Shelf life in months: +5°C to +25°C (+41 to +77°F)	12	
	WEICON Gasket Maker in cured condition	
Shore hardness A (DIN 53505 / ASTM D 2240):	35	30
Elongation at break ISO 37, S3A [%]	500	
Tensile strength ISO 37, S3A [N/mm ²]	2,0 N/mm ² (290 psi)	
Tension strength value at 100 % (ISO 37, S3A)	0,9 N/mm ² (130 psi)	0,7 N/mm ² (100 psi)
Movement capacity max. %:	15	15
Temperature resistance:	-60°C to +280°C (-76°F bis +536°F) briefly up to (approx. 2 h) +300°C (+572°F)	
Paintable:	cannot be painted	
Building material category (DIN 4102):	B 2	

*³ Normal climate +23°C (+73°F) and 50% relative humidity in accordance with DIN 50014.

Adhesives / Sealants
 Technical Sprays
 Technical Liquids
 Assembly Pastes
 Lubricants
 WEICON TOOLS®
 Other

Gasket Maker and Plast-o-Seal®

Plast-o-Seal®

Permanently plastic universal sealant | solvent-free with no unpleasant odour | enables immediate assembly



Features and advantages:

- ▶ for sealing the smoothly treated flanges of machine, gearbox and motor casing flanges
- ▶ can be used on hot and cold surfaces
- ▶ to improve the performance of both old and new gaskets made from paper, cork, felt etc.
- ▶ solvent-free – odourless
- ▶ remains permanently plastic, before and after assembly
- ▶ easy joint dismantling
- ▶ economical in use
- ▶ very good resistance to most fuels, mineral oils, water, air, coolant mixtures based on methanol and glycol, antifreezes, kerosene, fluorocarbon refrigerants etc.

- ▶ max. gap filling capability up to 0,10 mm (without a gasket)
- ▶ non-sag, can be applied to vertical surfaces
- ▶ temperature-resistant from -50°C to +200°C (-58 to +392°F); briefly up to +250°C (+482°F)
- ▶ compensates for manufacturing defects such as scoring and scratches and enables accurate assembly
- ▶ allows accurate assembly and construction with low tolerances
- ▶ no need to overtighten fixings during assembly
- ▶ non-corrosive
- ▶ contains no substances that disturb lacquer wettings (e.g. silicone)
- ▶ fluorescent blue colour

- ▶ 90 g **30000090** Tube
- ▶ 120 g **30000120** Brush-top can
- ▶ 230 g **30000230** Presspack
- ▶ 300 g **30000300** Cartridge

Technical data

Colour	blue (fluorescent)
Specific weight at +20°C	1,15 g/cm ³
Viscosity at +25°C (+77°F) Brookfield	950.000 - 1.650.000 mPa·s
Gap filling capacity max.	0,10 mm without gasket
Working temperature	+5°C up to +35°C (+41 up to +95°F)
Basis	Polyester resin
Shelf life	24 months at room temperature (approx. +20°C/+68°F)
Temperature resistance	-50 to +200°C (-58 to +392°F) briefly up to +250°C (+482°F)



100% PTFE

Thread Sealing Cord DF 175

plastic can 175 m
30010175



- ▶ for metal and plastic threads
- ▶ in extreme temperature ranges between -200°C
- ▶ silicone-free
- ▶ is used in the area of solar applications
- ▶ tested up to 45° reverse rotation
- ▶ cost- and time-saving application

WEICON DF 175 is used

- ▶ for almost all sealing of plastic and metal threads
- ▶ for ducts and pipes in which extremely aggressive media are transported
- ▶ in connection with gaseous or liquid media, such as oxygen, propane, butane and many more
- ▶ in the area of drinking water
- ▶ in extreme temperature ranges between -200°C (-328°F) and +240°C (+464°F)
- ▶ in the area of solar applications
- ▶ wherever an unscrewing of the connection (tested up to 45°) without weakening of the sealing effect is required



VIDEO



Thread Sealing Cord and Threadlocking Varnish

Threadlocking Varnish

Fast-drying | non-conductive | excellent media resistance

Threadlocking Varnish is a solvent-based, fast-drying securing and marking varnish with good adhesion to many materials.

The varnish serves as a removable lock, as protection against tampering by unauthorised persons, as a cover for electrically conductive parts and as protection against corrosion and influencing through contact.

The threadlocking varnish is resistant to water, petrol, diesel, mineral oil, paraffin oil and diluted acids and lyes. The threadlocking varnish is essential for locking screw connections of all kinds, protecting against manipulation and unauthorised loosening of screws and connections, documenting quality assurance measures, production control and product inspection through a varnish seal and also for the visual inspection of connected, adjusted parts.

Threadlocking varnish is available in the colours yellow, green and red.



Adhesives / Sealants

Technical Sprays

Technical Liquids

Technical Data

Colour	red (RAL 3000), yellow (RAL 1021), green (RAL 6010)
Degree of gloss	matt
Viscosity at +25°C (+77°F) acc. Brookfield	1.500 mPa·s
Processing temperature	+5°C to +120°C (+41°F to 248°F)
Dust dry after	5 minutes
Handling strength after	60 minutes
Final strength after	12 hours
Breakaway strength*	2,7 Nm
Temperature resistance	-60°C to +120°C (-76°F to 248°F)
Shelf life	12 months

*Strength values determined on screw M10 with full-area thread wetting

Assembly Pastes

Lubricants

WEICON TOOLS®

Other



- ▶ 30 g 30021030 ▶ 60 g 30021060 yellow: RAL 1021*

- ▶ 30 g 30022030 ▶ 60 g 30022060 green: RAL 6010*

- ▶ 30 g 30020030 ▶ 60 g 30020060 red: RAL 3000*

*corresponds approximately to the specified RAL colours



30951193



Cyanoacrylate Adhesives

WEICON Cyanoacrylate Adhesives are cold-curing 1-component adhesives, free of solvents. They quickly polymerise by reacting with moisture both on the surfaces to be bonded and from the air, and cure under light pressure.

They will bond within seconds almost all materials to and among each other, such as:

metals	plastics
glass	ceramics
wood	leather
natural and synthetic rubber	

When using WEICON Cyanoacrylate Adhesives, unlike in the case of welding and soldering, surfaces remain unaltered. No material stress occurs. Thus, more simple and rapid assembly is often possible, and auxiliary fixing devices are not necessary.

The resulting advantages are numerous:

- ▶ enormous time and, therefore, cost savings
- ▶ immediate processing of fixed parts possible
- ▶ high bond strength up to material fracture
- ▶ **clean and visually appealing bondings**



Type Selection Table

	VA 20	VA 8312	VA 8406	VA 100	VA 110	VA 1401	VA 300	VA 1500	GEL	VA 200 HR	VA 180 HT	VA 2500 HT	VA 30 Black	VA 250 Black	VA 1408	VA 1460	VA 1403	VM 20	VM 120	VM 2000
Metal	+	+	+	++	+	++	+	+	+	+	+	+	+	+	+	+	+	++	++	++
Plastic*	++	++	++	++	++	++	++	++	+	++	++	++	++	++	++	++	++	+	+	+
Rubber	++	++	++	++	++	++	+	++	+	++	++	++	++	++	++	++	+	+	+	+
EPDM-Elastomers	+	+	++	+	+	++	+	+		++	+	+	+	+	+	+	+			
Wood	+			+	+	+	++	+	+	+	+	+	+	+	+		++			
Balsa-wood		+	+	+	+	+	+	+	++		+	+	+	+	+		++			
Glass/ Ceramic	+		+	++	+	++	++	+	++	+	++	+	+	+	++	+	+			
Leather		+		++	+	++	++	++	++	++	+	+	+	+	+	+	++			

*s. page 93 Contact Primer

suitable (+)

highly suitable (++)

1-Component Adhesives and Sealants

Cyanoacrylate Adhesives

VA 20



Cyanoacrylate Adhesive for rubber and plastics | low viscosity | very fast curing | ISEGA-certified

WEICON Contact VA 20 has low viscosity (< 20 mPa•s) and cures very quickly.

VA 20 is suited for the bonding of rubber and plastics and also for precisely fitted metal/ plastic joints.

- ▶ 12 g ▶ 30 g ▶ 60 g
- 12000012 12000030 12000060

- ▶ 500 g
- 12000500



Adhesives / Sealants

Technical Sprays

Technical Liquids

VA 8312



Cyanoacrylate Adhesive for rubber and plastics | low viscosity | very fast curing | ISEGA-certified

WEICON Contact VA 8312 has low viscosity (20- 40 mPa•s) and cures very quickly. VA 8312 is suited for the bonding of various rubber materials such as solid rubber or cellular rubber, plastics and EDPM elastomers. The adhesive is certified by the ISEGA research and evaluation company and can be used as an adhesive in the food technology.

In combination with WEICON CA-Primer, VA 8312 can also be used for polyolefines (PE-polyethylene, PP-polypropylene). In combination with WEICON Contact Filler*, VA 8312 is suited for the instant bonding and filling of cracks, clefts, holes and uneven surfaces.

- ▶ 12 g ▶ 30 g
- 12200012 12200030

- ▶ 60 g ▶ 500 g
- 12200060 12200500



* WEICON Contact Filler

Fillers for instant bonding and filling-in of clefts and cracks, holes as well as unlevelled surfaces in combination with WEICON Contact Adhesive VA 8312.

Contact Filler should be applied in layers: **Adhesive - Filler - Adhesive**

After curing is completed, the material can be sanded and painted.

- ▶ 30 g
- 12650030



Assembly Pastes

Lubricants

WEICON TOOLS®

Other

VA 8406



Cyanoacrylate Adhesive for rubber and plastics | ISEGA-certified | low viscosity | very fast curing

WEICON Contact VA 8406 has low viscosity (20-50 mPa•s) and cures very quickly. It is suited for the fast fixing and bonding of various rubber materials such as solid rubber or cellular rubber, plastics and EPDM elastomers requiring quick fixing.

The adhesive is certified by the ISEGA research and evaluation company and can be used as an adhesive in the food technology. In combination with WEICON CA-Primer, VA 8406 can also be used for polyolefines (PEpolyethylene, PP-polypropylene) and for PTFE and silicones.

- ▶ 12 g ▶ 30 g ▶ 60 g
- 12204012 12204030 12204060
- ▶ 500 g
- 12204500



VIDEO



VA 100



Cyanoacrylate Adhesive for rubber and plastics | medium viscosity | slightly longer curing

WEICON Contact VA 100 is a universal type for the bonding of metals, plastic and rubber, both to and among each other.

VA 100 is ideal for the DIY sector, but can also be used in many areas of industry.

- ▶ 3 g ▶ 12 g ▶ 30 g
- 12050001 12050012 12050030
- ▶ 60 g ▶ 500 g
- 12050060 12050500

VA 110



Cyanoacrylate Adhesive for special requirements | medium viscosity | longer curing | drinking water approval

The special feature of the product is its NSF registration in accordance with ANSI Standard 61 - Drinking Water System Components. Thus, VA 110 also meets the highest standards and can be used in sensitive areas such as in the pharmaceutical industry, in the manufacturing of cosmetics, in the food industry, in the manufacturing of toys or jewelry industry.

Due to its special formula and the resulting NSF registration, VA 110 can contribute towards improvements in occupational safety and health protection.

- ▶ 12 g ▶ 30 g ▶ 60 g
- 12052012 12052030 12052060
- ▶ 500 g
- 12052500



1-Component Adhesives and Sealants

Cyanoacrylate Adhesives

VA 1401



Cyanoacrylate Adhesive for rubber and plastics | medium viscosity | fast curing | NSF approval

WEICON Contact VA 1401 has medium viscosity (100-150 mPa•s) and cures quickly. It shows good results on fabric, paper, cardboard, cartons, foam rubber and largepored elastomers. VA 1401 is a universal type for the bonding of metals, plastics and rubber, both to themselves and among each other.

- ▶ 12 g ▶ 30 g ▶ 60 g
- 12054012 12054030 12054060
- ▶ 500 g
- 12054500

VA 300

Cyanoacrylate Adhesive for rubber and plastics | higher viscosity | longer curing

WEICON Contact VA 300 has a higher viscosity (200-300 mPa•s) and a longer curing time. It is particularly suited for absorbent and porous products such as wood, cork, leather and ceramics.

VA 300 is also suited for the bonding of metals, plastics and rubber, both to themselves and among each other.

- ▶ 12 g ▶ 30 g ▶ 60 g
- 12100012 12100030 12100060
- ▶ 500 g
- 12100500

VA 1500

Cyanoacrylate Adhesive for rubber and plastics | high viscosity | slow curing

WEICON Contact VA 1500 is highly viscous (1000-1500 mPa•s) and has a slower curing time. The product is suited for the bonding of rubber and plastics and can also be used on absorbent and porous materials such as wood, cork, leather and ceramics.

- ▶ 12 g ▶ 30 g ▶ 60 g
- 12150012 12150030 12150060
- ▶ 500 g
- 12150500

Contact GEL

Cyanoacrylate Adhesive for special requirements | pasty (highly thixotropic) | very slow-curing = position correction

Contact Gel is pasty (highly thixotropic; 60000-90000 mPa•s) and cures very slowly. By using WEICON Activator Spray, the curing time can be reduced.

WEICON Contact Gel is suited for porous surfaces and higher tolerance gaps and can be used on vertical surfaces. Positioning is also possible after the parts have been joined.

WEICON Contact Gel is suited for the bonding of the most diverse products.

WEICON Contact Gel can be used both in the hobby sector and in model building. It can also be used in many different industrial applications.

- ▶ 20 g ▶ 30 g
- 12500120 12500130

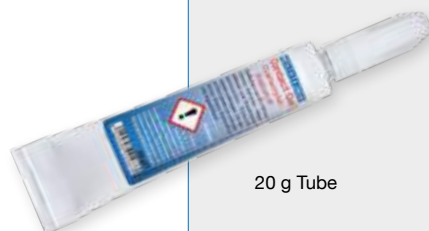

20 g Tube





VA 180 HT

180°C | 356°F
high-temperature-resistant

Cyanoacrylate adhesive for special requirements | high-temperature-resistant | fast-curing | medium viscosity | odourless

WEICON Contact VA 180 HT is a transparent cyanoacrylate adhesive for special requirements. It is high-temperature-resistant up to +180°C, fast-curing and odourless, and has medium viscosity.

The cyanoacrylate adhesive is suitable especially for the fixation of components, which are exposed to strong temperature fluctuations, for example when close to a running engine.

WEICON Contact VA 180 HT can be used in various industrial applications, such as in lamp and lightning construction, in the production of kitchen and electronic devices, or in areas where high temperatures can occur and a quick solution is needed.

- ▶ 12 g ▶ 30 g ▶ 60 g
- 12750012 12750030 12750060



VA 200 HR

excellent
moisture resistance

Cyanoacrylate adhesive for special requirements | moisture-resistant | low viscosity

WEICON Contact VA 200 HR is a transparent cyanoacrylate adhesive with low viscosity. It shows high ageing resistance and consistently high strength, even under prolonged influence of moisture and warmth. After several days under constant influence of moisture and warmth, the cyanoacrylate adhesive shows the same high performance.

Due to this high moisture resistance, VA 200 HR is suitable especially for applications exposed to varying weather conditions. The cyanoacrylate adhesive can be used in pipe and pipeline construction, for example, in the construction of kitchen and electronic devices, in tank and apparatus construction, in ventilation and air-conditioning technology, in gardening and landscaping as well as in sanitary facilities.

It is suitable for various applications, such as the attachment of a control unit in a dish washer, for the production of sealings for concrete pipes, for mounting accessories in rooms with increased air humidity such as kitchens or bathrooms, for mounting components for outdoor sports such as rubber profiles to a snowboard, or for attaching armrests to outdoor furniture.

- ▶ 12 g ▶ 30 g ▶ 60 g
- 12755012 12755030 12755060



VA 2500 HT

Cyanoacrylate Adhesive for special requirements | high-temperature-resistant | high viscosity | slow curing | residual elasticity after curing | high peel and impact resistance

WEICON Contact VA 2500 HT is highly viscous (2000-3000 mPa•s) and temperature-resistant between -50°C (-58°F) and +140°C (+284°F). It hardens slowly with residual elasticity and has high peel and impact strength.

Thanks to its curing with residual elasticity, WEICON Contact VA 2500 HT is particularly suitable under changing climatic conditions. It is insensitive even under a longer influence of humidity. VA 2500 HT is suited for the bonding of the most diverse rubber materials and plastics and also for metal/plastic joints.

- ▶ 12 g ▶ 30 g ▶ 60 g ▶ 500 g
- 12550012 12550030 12550060 12550050

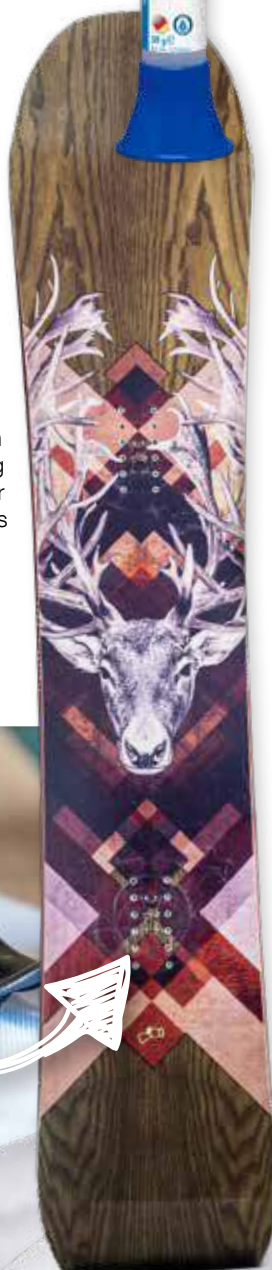

Adhesives / Sealants
Technical Sprays
Technical Liquids
Assembly Pastes
Lubricants
WEICON TOOLS®
Other

1-Component Adhesives and Sealants

Cyanoacrylate Adhesives

Temperature change load

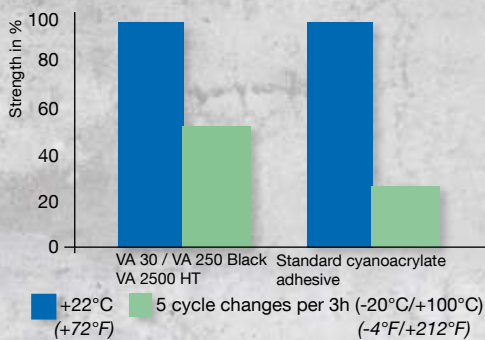

Humid climate resistance

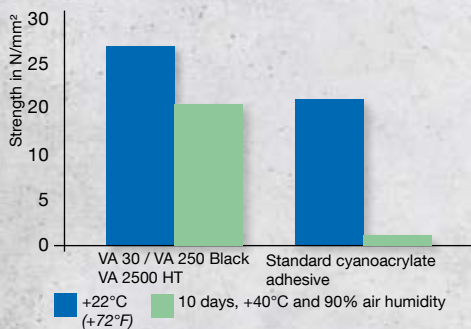

Short-term ageing at +140°C (+284°F)

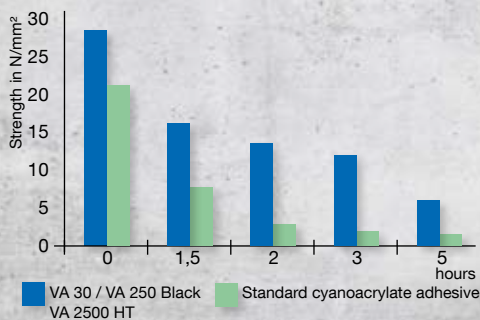

Strength dependent on temperature

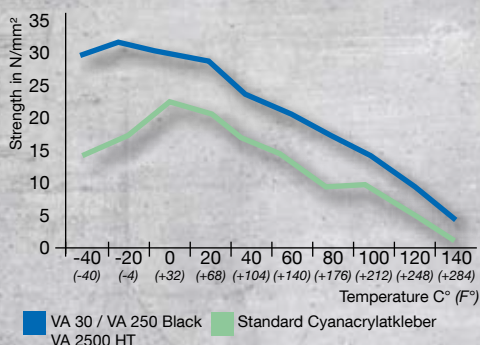

VA 30 Black

Cyanoacrylate Adhesive for special requirements | rubber-filled | high-temperature-resistant | medium viscosity | longer curing | residual elasticity after curing | high peel and impact resistance

WEICON Contact VA 30 Black has medium viscosity (300 mPa•s) and is temperature-resistant between -50°C (-58°F) and +140°C (+284°F). It has a longer curing time, is rubber-filled and black, hardens with residual elasticity and has high peel and impact strength. Thanks to its curing with residual elasticity, WEICON Contact VA 30 Black is particularly suitable under changing climatic conditions.

It is insensitive even under a longer influence of humidity. VA 30 Black is ideally suited for the bonding of diverse rubber materials such as solid rubber or cellular rubber, plastics and metal/plastic joints.

- ▶ 12 g ▶ 30 g ▶ 60 g ▶ 500 g
- 12603012 12603030 12603060 12603500

VA 250 Black

Cyanoacrylate Adhesive for special requirements | rubber-filled | high-temperature-resistant | high viscosity | slow curing | residual elasticity after curing | high peel and impact resistance

VA 250 Black is highly viscous (2000-3000 mPa•s) and temperature-resistant between -50°C (-58°F) and +140°C (+284°F). It hardens slowly and with residual elasticity, is rubber-filled and black, and has high peel and impact strength.

Thanks to its curing with residual elasticity, WEICON Contact VA 250 Black is particularly suitable under changing climatic conditions. It is insensitive even under a longer influence of humidity. It is best suited for the bonding of diverse rubber materials such as solid rubber or cellular rubber, plastics and metal/plastic joints.

- ▶ 12 g ▶ 30 g ▶ 60 g ▶ 500 g
- 12600012 12600030 12600060 12600500



Adhesives / Sealants

Technical Sprays

Technical Liquids

Assembly Pastes

Lubricants

WEICON TOOLS®

Other



VA 1408

Cyanoacrylate Adhesive for special requirements | low viscosity | very fast curing | low odour and “blooming”

WEICON Contact VA 1408 has a low viscosity (20-40 mPa•s) and a reduced “blooming” effect. It cures quickly, is low in odour when processing and less susceptible to moisture effects after curing.

The product is suited for the clean and visually attractive bonding of the most diverse products. WEICON Contact VA 1408 can be used in numerous industrial applications.

- ▶ 12 g ▶ 30 g ▶ 60 g ▶ 500 g
- 12253012 12253030 12253060 12253500



VA 1460

Cyanoacrylate Adhesive for special requirements | medium viscosity | longer curing | low odour and “blooming”

VA 1460 has a medium viscosity (120-200 mPa•s) and a reduced “blooming” effect. It cures less quickly, is low in odour when processing and less susceptible to moisture effects after curing.

WEICON Contact VA 1460 is suited for the bonding of the most diverse products. The product can be used in numerous industrial applications.

- ▶ 12 g ▶ 30 g ▶ 60 g ▶ 500 g
- 12250012 12250030 12250060 12250500



VA 1403

Cyanoacrylate Adhesive for special requirements | high viscosity | slow-curing | low odour and “blooming”

WEICON Contact VA 1403 is highly viscous (1100-1800 mPa•s), low in odour when processing and has a reduced “blooming” effect. It cures slowly and is less susceptible to moisture effects after curing.

VA 1403 is suited for the clean and visually attractive bonding of various products.

- ▶ 12 g ▶ 30 g ▶ 60 g ▶ 500 g
- 12252012 12252030 12252060 12252500

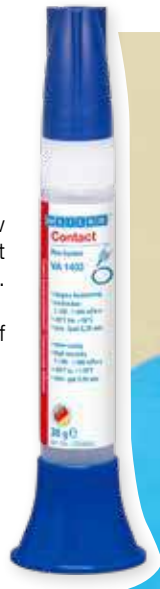

1-Component Adhesives and Sealants

Cyanoacrylate Adhesives



VIDEO

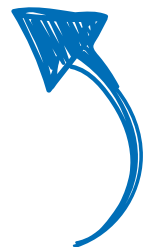

Adhesives / Sealants

Technical Sprays

Technical Liquids

Assembly Pastes

Lubricants

WEICON TOOLS®

Other

VM 20

Cyanoacrylate Adhesive for metals | low viscosity | very fast curing

WEICON Contact VM 20 has a low viscosity (20-40 mPa•s) and cures very quickly. It is suited for all types of metal bonds, especially for the bonding of precisely fitted parts in serial production.

VM 20 can be used in the metalworking industry, in machine construction, in housing and apparatus engineering and in many other applications.

- ▶ 30 g ▶ 60 g ▶ 500 g
- 12300030 12300060 12300500



VM 120

Cyanoacrylate Adhesive for metals | medium viscosity | slower curing, a short-term realignment of parts is possible

WEICON Contact VM 120 is suited for all types of metal bonds.

WEICON Contact VM 120 can be used in the metalworking industry, in machine construction, in housing and apparatus engineering and in many other applications.

- ▶ 30 g ▶ 60 g ▶ 500 g
- 12350030 12350060 12350500



VM 2000

Cyanoacrylate Adhesive for metals | high viscosity | slow curing, allows realignment of parts

WEICON Contact VM 2000 is highly viscous (1700-2000 mPa•s) and cures slowly, which enables realignment of the bonded parts.

VM 2000 is suited for all types of metal bonds and can also be used on absorbent and porous products.

- ▶ 30 g ▶ 60 g ▶ 500 g
- 12400030 12400060 12400500



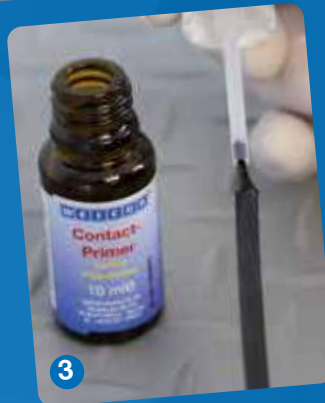

O-Ring Bonding Set

Using the WEICON O-Ring Bonding Set, sealing rings out of all common materials can be produced in no time.

WEICON O-Ring Bonding Set consists of:

- 12603012 | Contact VA 30 Black | 12 g
- 11207150 | Surface Cleaner | 150 ml
- 12450010 | Contact Primer | 10 ml
- 99950243 | Safety Knife
- 1 m round cord (NBR) each: Ø 2, 3, 4, 6 and 8 mm

12508030

1-Component Adhesives and Sealants O-Ring Bonding Set and Accessories for CA



▶ 10 ml 12450010
▶ 100 ml 12450100
▶ 1 L 12450901



▶ 150 ml
12500150
CA-Activator
Spray



▶ 150 ml
12505150
CA-Activator Spray AC
(based on acetone)

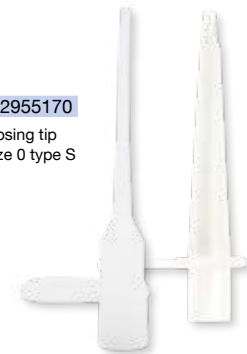

12955170
Dosing tip
size 0 type S

12955175
Dosing tip A
size 0,5

Contact Primer for Polyolefines

Without pre-treatment, many plastics are unable to bond or bond only under certain conditions. When these plastics are pre-treated with WEICON Contact Primer, their surface structure changes. Thereby the joining of plastics, like polyethylene (PE) and polypropylene (PP) belonging to the polyolefine group, which are usually difficult to bond, is made possible. Even modern thermoplastic elastomers (TPE), PTFE and related plastics as well as silicones, can be bonded when pre-treated with WEICON Contact Primer.



Contact Activator

The activator speeds up the curing process of WEICON Cyanoacrylate Adhesives. When applied to absorbent surfaces, like wood or foam etc., and all chemically-treated surfaces, such as zinc-galvanized metals etc., the activator's effectiveness lasts approx. one minute. With non-absorbent surfaces, the activator's effectiveness lasts up to approx. 12 hours.

Due to its special formula and the resulting NSF registration, CA-Activator Spray and CA-Activator Spray AC can contribute towards improvements in occupational safety and health protection.

Use is recommendable with:

- ▶ highly viscous WEICON Contact types
- ▶ large thickness of the adhesive layer
- ▶ absorbent and porous surfaces
- ▶ passive materials (alkaline surfaces, like for example zinc coated metal parts).
- ▶ disadvantageous environmental conditions (low temperatures, too low air humidity < 30%)

Dosing Tips

For exact, economic and point-to-point applications of WEICON Contact adhesives.

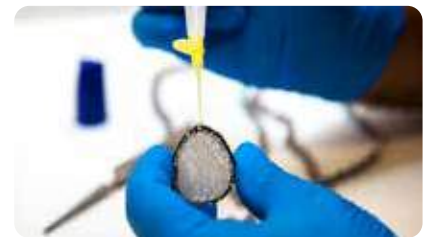

CA-Remover

Breaks down and removes all types of cyanoacrylate adhesives. Suitable for cleaning metal parts, tools and many different surfaces that have come into contact with cyanoacrylate adhesives.



▶ 30 ml
12470030

Combined tension and shear resistance (DIN EN 1465) / ASTM D 1002:

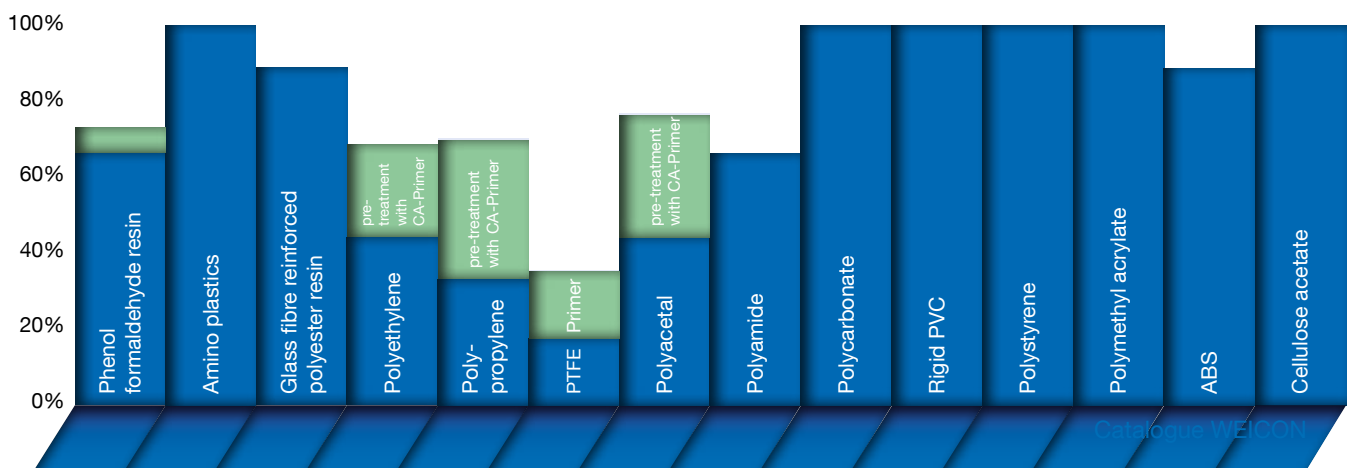

Technical Data

WEICON Contact in liquid state

	VA 20	VA 8312	VA 8406	VA 100	NSF Certified by NSF/ANSI 61	NSF Certified by NSF/ANSI 61	VA 300	VA 1500	GEL	VA 200 HR	VA 180 HT	VA 2500 HT	VA 30 Black	VA 250 Black	VA 1408	VA 1460	VA 1403	VM 20	VM 120	VM 2000	
	✓	✓	✓	✓																	
Ester type	Ethyl														Alkoxy			Methyl			
Condition / nature	colourless, clear liquid, VA 2500 HT opaque, VA 30 Black and VA 250 Black																				
Properties	particularly suitable for rubber and plastic bonding								pasty	by humidity	low odour, temperature- resistant	particularly suitable for rubber and plastic bonding			low odour, low blooming			particularly suitable for bonding metals			
Viscosity at 25°C cone / plate in mPa·s	< 20	20-40	20-50	60- 120	70- 110	100- 150	200- 300	1000- 1500	60000- 90000	120-200	300-400	2000- 3000	250- 300	2000- 3000	20-40	120- 200	1100- 1800	20-40	100- 130	1700- 2000	
Max. gap covering in mm **	0,10	0,10	0,10	0,15	0,15	0,15	0,15	0,20	0,20	0,15	0,15	0,20	0,20	0,20	0,10	0,15	0,20	0,10	0,15	0,20	
Specific gravity at +20°C (+68°F) g/cm³	1,04	1,05	1,05	1,06	1,06	1,06	1,07	1,08	1,08	1,09	1,06	1,06	1,06	1,06	1,06	1,02	1,10	1,10	1,10	1,10	1,12
Flash point	+87°C (+189°F)																				
Initial adhesion* in seconds	Aluminium ¹⁾	30-60	30-60	2-10	30-60	20-50	2-10	60-90	90-120	90-120	60-90	20-50	40-80	40-50	90-120	30-60	30-60	90-120	50-70	50-70	70-90
	Nora Test rubber ²⁾	2-15	2-10	< 5	3-20	3-15	< 5	2-10	5-30	20-30	5-20	5-20	25-60	5-10	20-40	3-20	10-60	5-30	10-60	10-60	10-90
	Rigid PVC ³⁾	5-60	5-30	2-10	10-60	10-50	2-10	10-60	10-120	40-80	90-150	40-100	25-100	5-10	40-80	10-30	20-150	10-120	30-120	30-120	30-150
Final strength in hours	24																				

1-Component Adhesives and Sealants

Cyanoacrylate Adhesives

Technical Data

WEICON Contact in cured state

		VA 20	VA 8312	VA 8406	VA 100	NSF Certified to NSF/ANSI 61	NSF Food Contact Approved	VA 300	VA 1500	GEL	VA 200 HR	VA 180 HT	VA 2500 HT	VA 30 Black	VA 250 Black	VA 1408	VA 1460	VA 1403	VM 20	VM 120	VM 2000		
Shear strength in N/mm ² (psi) according to DIN EN 1465	Sand-blasted steel	19 (2.750)	20 (2.900)	22 (3.200)	20 (2.900)	20 (2.900)	22 (3.200)		21 (3.050)		20 (2.900)	14 (2.030)	24 (3.450)	22 (3.200)	24 (3.450)		18 (2.600)				25 (3.600)		
	Sand-blasted aluminium	14 (2.050)	14 (2.050)	16 (2.300)	15 (2.175)	15 (2.175)	16 (2.300)		15 (2.175)		15 (2.175)	18 (2.600)	18 (2.600)	18 (2.600)	18 (2.600)		12 (1.750)				19 (2.750)		
	Rigid PVC	12 (1.750)	13 (1.900)	14 (2.050)	13 (1.900)	13 (1.900)	14 (2.050)		13 (1.900)		13 (1.900)	13 (1.900)	13 (1.900)	14 (2.050)	13 (1.900)		7 (1.000)				12 (1.750)		
	ABS	11 (1.600)	12 (1.750)	13 (1.900)	12 (1.750)	12 (1.750)	13 (1.900)		12 (1.750)		13 (1.900)	12 (1.750)	12 (1.750)	12 (1.750)	11 (1.600)	12 (1.750)		10 (1.450)				11 (1.600)	
	PC	12 (1.750)	13 (1.900)	13 (1.900)	13 (1.900)	13 (1.900)	13 (1.900)		12 (1.750)		10 (1.450)	9 (1.305)	13 (1.900)	13 (1.900)	13 (1.900)	13 (1.900)		8 (1.150)				12 (1.750)	
	NBR	> 8 (1.150) (bonding exceeds strength of substrate)																					
Temperature resistance		-50 to +80°C (-58 to +176°F) (briefly up to +100°C/+212°F)					-50 to +120°C (-58 to +248°F) (briefly up to +150°C/302°F)	-50 to +80°C (-58 to +176°F) (briefly up to +100°C/+212°F)	-50 to +80°C (-58 to +176°F)	-55 to +180°C (-67 to +356°F)		-55 to +140°C (-67 to +284°F)		-50 to +80°C (-58 to +176°F) (briefly up to +100°C/+212°F)									
Squatting temperature		+150°C (302°F)																					
Refractive index n _D ²⁰		approx. 1,49 (similar to glass) / for types VA 30 Black and VA 250 Black not applicable																					
Linear thermal expansion coefficient		approx. 80 · 10 ⁻⁶ m/(m·K)																					
Specific forward resistance, DIN IEC93		> 10 ¹⁵ Ω·cm																					
Dielectric strength		25 KV/mm																					
Thermal conductivity DIN EN ISO 22007-4		approx. 0,1 W/(m·K)																					
Solubility		Dimethyl formamide, dimethyl sulfoxide, acetonitrile, alkali. Swelling is possible after long-time storage in ethyl acetate, acetone and methylene chloride.																					

*Achieved in normal climate DIN 50014 +23°C (+73°F) and 50% relative air humidity. Within the given time period, handling strength can be reached.
 ** These details are dependent on the type of material to be bonded and its properties
 *** Following the DIN-norm measured on bonding joints.

- 1) Aluminium. Type Al Cu Mg 2pl., not pre-treated
- 2) NBR-rubber, smoothed
- 3) Rigid PVC Trovidur® EN, not pre-treated

MS-Polymers

Product	Page
Flex 310 M® Classic	99
Flex 310 M® Crystal	99
Flex 310 M® Stainless-Steel	100
Flex 310 M® Super-Tack	100
Flex 310 M® Liquid	100
Flex 310 M® HT 200	101
Flex 310 M® 2 K	101
Speed-Flex®	102
Speed-Flex® Crystal	102
Windscreen Adhesive	102
Flex+bond®	103
Flex+bond® Liquid	103
Flex 310 M® FireSeal	104
Flex 310 M® ProSeal	104
Solar-Flex®	105
Aqua-Flex	105

Polyurethanes

Flex 310 PU	108
Fast-Bond	108

**WEICON
Cartridge Guns**

Cartridge Gun	109
Cartridge Gun Special	109
Compressed Air Cartridge Gun	109
Cartridge Gun 2 K 10:1	109

Silicones

Product	Page
Silicone A	110
Silicone LP	110
Silicone F	110
Silicone N	111
HT 300	111
Black-Seal	111

**Bonding
Agents**

Primer and Smoothing Agent	117
----------------------------	-----



**WEICON
Mounting Tape**

Transparent	118
Grey	119

Contact Adhesives

GMK 2410/2510	120-121
---------------	---------

Elastic Adhesives and Sealants

Adhesives / Sealants

Technical Sprays

Technical Liquids

Assembly Pastes

Lubricants

WEICON TOOLS®

Other

Elastic Adhesives / Sealants

Today, elastic adhesives and sealants are used in many areas of industrial production and assembly. They combine the advantages of adhesive bonding and sealing technology and are used wherever the elasticity and the sealing of a joint are the most important requirements.



Surface pre-treatment



Most materials can be bonded well to themselves and among each other. For certain materials or extreme requirements, we recommend the use of an adhesion agent (primer).

A mechanical surface pre-treatment, e.g. sanding or sandblasting, can considerably improve the adhesion.

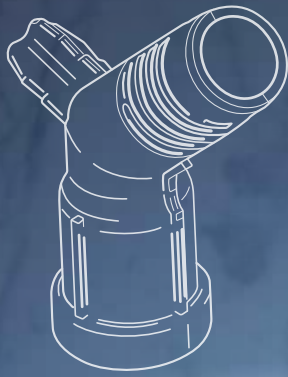

INNOVATION



Ergo Connect for Presspack NEW

Ergonomic dosing tip for WEICON Presspack products.

The optimised angle geometry ensures fatigue-free working even over longer periods of time. The two-way thread enables an application radius of 180°. Compatible with WEICON dosing tips and brush top.

Adhesives / Sealants

Technical Sprays

Technical Liquids

Assembly Pastes

Lubricants

WEICON TOOLS®

Other



ERGONOMIC
handling

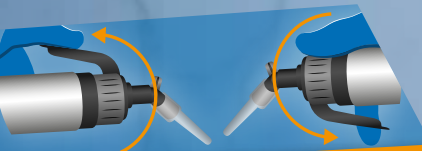

180° APPLICATION
thanks to two-way thread



IDEAL ANGLE
for perfect applications

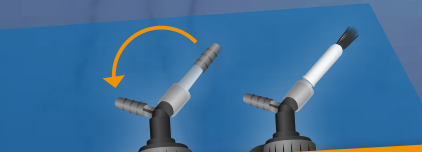

SAFE AND FLEXIBLE
cap can be locked
compatible with WEICON dosing tip and brush top

Presspack Ergo Connect 10-pack

13890002



Dosing tips 10-pack

13955072



Elastic Adhesives and Sealants

MS-Polymers

Flex 310 M® Classic



Suitable for universal use | ISEGA-certified

WEICON Flex 310 M Classic Adhesive and Sealant is strong, paintable (wet-on-wet), sandable, has outstanding ageing stability and good resistance to UV rays. It is resistant to freshwater and salt water and is free of silicone, isocyanate, halogens or solvents.

The product has an ISEGA certificate and can be used as an adhesive in food technology. Flex 310 M Classic is an elastic adhesive on MS polymer basis and is suitable for the bonding of metals, many plastics, ceramic, wood, glass and stone. WEICON Flex 310 M Classic can be used in metal construction, tank and apparatus engineering, carriage, vehicle and container construction, ventilation and air conditioning systems, in the electrical industry, yacht and boat construction and in all applications where silicones or products containing silicones are not suitable.

▶ 310 ml 13303310 white	▶ 310 ml 13305310 grey	▶ 310 ml 13304310 black
▶ 200 ml 13303200 Presspack	▶ 200 ml 13305200 Presspack	▶ 200 ml 13304200 Presspack

Flex 310 M® Crystal



Crystal-clear curing | ISEGA-certified

WEICON Flex 310 M Crystal adhesive and sealant is transparent, strong, paintable (wet in wet), sandable, has outstanding ageing stability and good resistance to UV rays. It contains no silicone, isocyanate, halogens or solvents.

WEICON Flex 310 M Crystal has an ISEGA certificate and can be used as an adhesive in food technology.

WEICON Flex 310 M Crystal is an elastic adhesive on MS polymer basis and is suitable for the bonding of glass, PC*, PMMA* and acrylic glass*, metals, many plastics, ceramics, wood and stone. The product is crystal clear after curing and is particularly suited for elastic joints where the adhesive should or must not be visible.

Flex 310 M Crystal can be used in plastic processing, metal construction, tank and apparatus engineering, in ventilation and air conditioning systems, the electrical and lighting industry, in exhibition stand construction and shopfitting and in all applications where silicones or products containing silicones are not suitable.

*1 = Only tension-free bonding

▶ 310 ml 13308310	▶ 200 ml 13308200 Presspack
----------------------	-----------------------------------



Flex 310 M® Stainless-Steel



For stainless steel, aluminium and non-ferrous metals | ISEGA-certified

WEICON Flex 310 M Stainless-Steel Adhesive and Sealant is non-corrosive, strong, paintable (wet-on-wet), sandable, resistant to ageing and UV rays and is free of silicone, isocyanate, halogens or solvents. WEICON Flex 310 M Stainless-Steel is an elastic adhesive on MS polymer basis and is suitable for bonding and sealing of seams and joints on metals such as stainless steel, aluminium and non-ferrous metals. Flex 310 M Stainless-Steel can also be used in all application fields where the colour of the adhesive and sealant must match the surface material (e. g. stainless steel, aluminium, etc.).

WEICON Flex 310 M Stainless-Steel can be used in metal construction, tank and apparatus engineering, food industry, in kitchen and sanitary installations, ventilation and air conditioning systems, and in all applications where silicones or products containing silicones are not suitable.

310 ml

13656310

Stainless-Steel



Flex 310 M® Super-Tack

High initial strength

WEICON Flex 310 M Super-Tack Adhesive and Sealant is very strong, non-corrosive, paintable (wet-on-wet), sandable, weather resistant, resistant to UV rays and is free of silicone, isocyanate, halogens or solvents. Flex 310 M Super-Tack is a strong, elastic adhesive on MS polymer basis. Both the very high initial bonding power and the fast development of adhesive strength enable bonds to be achieved even on vertical surfaces.

WEICON Flex 310 M Super-Tack is suitable for the bonding of metals, many plastics, ceramics, wood, glass and stone. It replaces screws, pegs, rivets and other traditional fixings. Flex 310 M Super-Tack can be used for drywall and interior work, in metal construction, tank and apparatus engineering, ventilation and air conditioning systems, in yacht and boat constructions, exhibition stand construction and shopfitting and in all applications where silicones or products containing silicones are not suitable.

▶ 290 ml

13650290
white

▶ 290 ml

13652290
grey



Flex 310 M® Liquid black **NEW**



Liquid | self-levelling | ISEGA-certified

Flex 310 M Liquid black is a self-levelling, 1-component casting and coating mass based on polyoxypropylene. The product is permanently elastic and paintable after curing. The flexible adhesive and sealant cures odourless, is resistant to weather and UV rays, has an excellent resistance to ageing and is free of silicone.

Flex 310 M Liquid black can be used in diverse applications for the bonding and sealing of many different materials such as metals, many plastics, ceramics, wood, glass or stone and for insulation and impregnation.

The flexible adhesive and sealant can also be used in other industrial areas, such as in tank and apparatus construction, in car bodywork, container and vehicle construction, in pipeline and fittings construction, in the energy and electrical industries, in sound insulation and insulation technology and in plastics technology.

▶ 310 ml

13706310
black

Flex 310 M® Liquid



Liquid | self-levelling | ISEGA-certified

Flex 310 M Liquid is a self-levelling, 1-component casting and coating mass based on polyoxypropylene. He is permanently elastic and paintable (wet-on-wet). The flexible adhesive and sealing substance cures odourless; is weather- and UV-resistant, shows excellent resistance to ageing and is free of silicone.

Flex 310 M Liquid can be used in diverse applications for adhesion and sealing of very different materials such as metals, many plastics, ceramics, wood, glass or stone and for insulation and impregnation. Flex 310 M Liquid is certified by the ISEGA research and evaluation company and can be used as an adhesive in the food technology. The flexible adhesive and sealing substance can also be used in other industrial areas, such as in tank and apparatus construction, in car bodywork, container and vehicle construction, in pipeline and fittings construction, in the energy and electrical industries, in sound insulation and insulation technology and in plastics technology.

▶ 310 ml

13333310
white



Adhesives / Sealants
Technical Sprays
Technical Liquids
Assembly Pastes
Lubricants
WEICON TOOLS®
Other

Elastic Adhesives and Sealants

MS-Polymers

Flex 310 M® HT 200

High-temperature-resistant

The high temperature resistance makes it possible to bond and seal components needing to be subsequently thermal-coated (powdercoated).

WEICON Flex 310 M HT 200 can be used in metal construction, tank and apparatus engineering, in ventilation and air conditioning systems, carriage, container, wagon and vehicle construction.

WEICON Flex 310 M HT 200 adhesive and sealant is highly temperature-resistant, has outstanding ageing resistance, and is free of silicone, isocyanate, halogens or solvents.

► 310 ml
13655310
grey

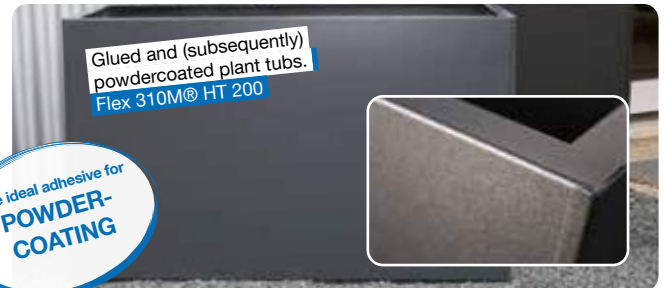

The ideal adhesive for
POWDER-COATING



Flex 310 M® 2 K

Fast-curing

The WEICON Flex 310 M 2 K Adhesive and Sealant is very strong, non-corrosive, paintable (wet in wet), sandable, weather-resistant, resistant to UV rays and is free of silicone, isocyanate, or solvents.

Flex 310 M 2 K is a strong 2-component system on a hybrid polymer basis which enables fullsurface bonding of larger parts and which can be used to fill gaps of up to ten millimetres. It is suitable for the bonding of almost all materials such as metal and many plastics.

WEICON Flex 310 M 2 K can be used in metal construction, tank and apparatus engineering, machine and system construction, in the furniture industry, in ventilation and air conditioning systems, in the electrical industry, yacht and boat construction and in all applications where silicones or products containing silicones are not suitable.

► 250 ml
13305250
grey



Special Mixing Nozzle

13309997

Speed-Flex®



Replaces traditional fixings | ISEGA-certified

WEICON Speed-Flex is very strong, pasty, stable, paintable (wet-on-wet), resistant to ageing, weathering, and UV rays and is free of silicone, isocyanate and halogen. WEICON Speed-Flex has an ISEGA certificate and can be used as an adhesive in foodstuff technology.

WEICON Speed-Flex is an adhesive on MS polymer basis with extremely strong initial strength and is suitable for the bonding of metals, many plastics, ceramics, wood, glass and stone.

Speed-Flex replaces traditional fixings such as screws, pegs, rivets, etc. The very high initial strength makes bonding possible even on vertical surfaces in indoor and outdoor areas. WEICON Speed-Flex can be used for drywall and interior work, metal construction, tank and apparatus engineering, in ventilation and air conditioning systems, in exhibition stand construction and shopfitting and in all applications where silicones or products containing silicones are not suitable.

- ▶ 310 ml ▶ 310 ml
- 13600310 13602310
- white grey

Speed-Flex® Crystal



Crystal-clear adhesion | ISEGA-certified

Speed-Flex Crystal is a quick-acting, strong and general-purpose power adhesive on MS polymer basis.

Due to its crystal-clear curing properties, Speed-Flex Crystal is particularly suitable in areas which should remain visually appealing, where no adhesive seam should be visible. Thus e.g. transparent plastics, acrylic glass or other materials can be connected quickly, cleanly and reliably.

- ▶ 310 ml
- 13608310
- transparent



- ▶ 310 ml
- 13608310
- transparent

Windscreen Adhesive



Elastic 1-C adhesive and sealant for mounting glass and window panes | ISEGA-certified

WEICON Windscreen Adhesive is an elastic 1-C adhesive and sealant based on MS-Polymer, which is specially designed to mount glass and window panes. For example, the adhesive bonds windscreens, rear windows and side windows in powered industrial trucks, agricultural machines, and construction machines. It is also suitable for furniture manufacture or for installations in gardening and landscaping.

Windscreen Adhesive provides high adhesive strength on many materials and cures with air humidity. The adhesive shows excellent ageing resistance and good UV stability. It is joint-filling, odourless, and free of silicones, isocyanates, halogens, and solvents.

- ▶ 200 ml ▶ 310 ml
- 13711200 13711310
- Presspack Cartridge



Elastic Adhesives and Sealants MS-Polymers

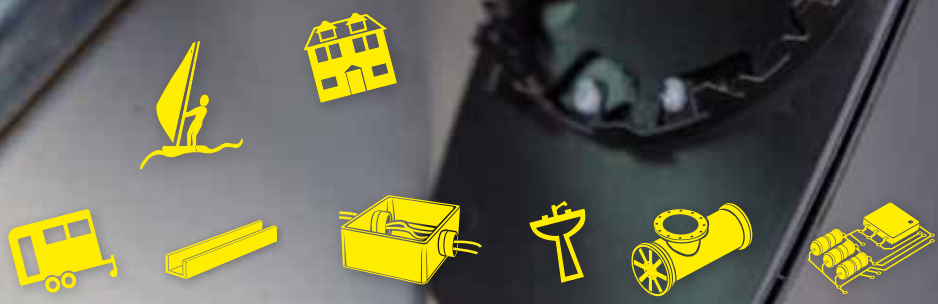

Adhesives / Sealants

Technical Sprays

Technical Liquids

Assembly Pastes

Lubricants

WEICON TOOLS®

Other

Flex+bond®



Highly elastic | strong | ISEGA-certified

WEICON Flex+bond is strong, permanently elastic, temperature-resistant from -40°C to +90°C (-40°F to +194°F), weather-resistant, resistant to UV rays, paintable (wet-on-wet), sandable, and resistant to ageing and salt water. It is free of silicone, isocyanate, halogens and solvents.

WEICON Flex+bond has an ISEGA certificate and can be used as an adhesive in foodstuff technology. WEICON Flex+bond can be used to bond nearly all materials, such as metal, wood, plastic, glass, and ceramics.



- ▶ 85 ml 13350085 white
- ▶ 85 ml 13352085 black
- ▶ 85 ml 13351085 grey
- ▶ 85 ml 13353085 transparent



13359085
Sales display



Flex+bond® Liquid



Self-levelling, one-component casting and coating mass | ISEGA-certified

Flex+bond Liquid is a self-levelling, one-component casting and coating mass up to a layer thickness of max. 10 mm.

Flex+bond Liquid cures odourless, is based on MS-Polymer and is free of solvents, isocyanates and silicone. The compound is suitable for different applications, such as castings in the electrical and electronics industry or casting of cable connections.

It can be used in the insulation technology, in metal construction, in the tank and apparatus construction, in valve construction and in the ventilation and air conditioning technology.

- ▶ 85 ml 13354085 white



- ▶ suitable for maritime ventilation systems
- ▶ for applications in sensitive areas and for room ventilation systems

Flex 310 M® ProSeal NEW

Multi-purpose high-strength adhesive and sealant

Multi-purpose, permanently elastic, fast-curing and high-strength 1-C adhesive and sealant based on SMP. Neutral curing, entirely weather-resistant, very low emissions and odour as well as free of silicone, isocyanate and solvents. Tested and approved for applications in food-related areas and for ventilation and air-conditioning systems in accordance with VDI 6022. Meets the requirements of the International Maritime Organisation IMO FTPC Parts 2+5.

WEICON Flex 310 M® ProSeal adheres very well even to powder-coated, painted, galvanised, anodised, chromated and hot-dip galvanised surfaces. Adhesion range: metal, plastics, natural stone, concrete, masonry, plaster, wooden floors, glass, and many more. The sealant has a high mould

resistance, is compatible with natural stone and can be used in many areas, such as food and beverage production, air conditioning and ventilation construction, the maritime industry, sanitary facilities, or the construction industry.

Moreover, WEICON Flex 310 M® ProSeal can be used in other industrial areas, such as in tank and apparatus construction, in car bodywork, container and vehicle construction, in pipeline and fittings construction, in the energy and electrical industries, in sound insulation and insulation technology and in plastics technology.

▶ 310 ml
13372310
grey



Flex 310 M® FireSeal NEW

Permanently elastic adhesive and sealant based on SMP with a fire resistance up to 120 minutes | tested and classified for all joint structures according to EN 1366-4

The paint-compatible sealant with very low volume shrinkage meets the highest demands in terms of fire protection, such as the requirements of the International Maritime Organisation IMO FTPC Parts 2+5 as well as for rail vehicles in accordance with DIN EN 45545-2 R22/23 HL3. The very low emissions allow safe indoor application.

Flex 310 M® FireSeal adheres very well even to powdercoated, painted, galvanised, anodised, chromated and hot-dip galvanised surfaces. It is suitable for use on metal, plastics, concrete and wood. The adhesive and sealant can be used in many application

areas. It is suitable for fire barriers and covers, for joints in non-structural components with fire resistance requirements, for connection joints and for sealing cable ducts, pipe openings and housings. Flex 310 M® FireSeal can also be used in other industrial areas, such as vehicle and body construction, container construction, apparatus and fittings construction, the energy and electrical industries, insulation technology and plastics technology.

▶ 310 ml
13375310
concrete-grey



- ▶ fire resistance up to 120 minutes
- ▶ meets the highest standards in maritime fire protection and in rail vehicle construction

DIN EN 45545-2 R22/23 HL3



Elastic Adhesives and Sealants MS-Polymers

Solar-Flex®

Developed for solar industry

WEICON Solar-Flex® is strong, non-corrosive, paintable (wet-on-wet), weather-resistant and resistant to UV rays. It is free of silicone, isocyanate, halogens and solvents. WEICON Solar-Flex® is an elastic adhesive on MS polymer basis specially developed for the solar industry.

Both the very high initial bonding strength and the fast development of adhesive strength enable bondings even on vertical surfaces. Replaces traditional fixings in the assembly of solar and photovoltaic power systems.

- ▶ 290 ml ▶ 290 ml
- 13750290** **13752290**
- white grey



Especially for the solar industry



Adhesives / Sealants

Technical Sprays

Technical Liquids

Ideal for wet and moist surfaces

Aqua-Flex



Ideal for wet and moist surfaces | ISEGA-certified

WEICON Aqua-Flex Adhesive and Sealant is strong, has outstanding ageing stability, and is resistant to weathering, UV rays, freshwater and salt water. It is free of silicone, isocyanate, halogens or solvents.

Aqua-Flex has an ISEGA certificate and can be used as an adhesive in foodstuff technology.

WEICON Aqua-Flex is an elastic adhesive and sealant on MS polymer basis for wet and damp substrates. It is suitable for the bonding of numerous materials such as metal, plastic, ceramics, wood, glass and stone.

Aqua-Flex can be used for pipeline and cable work, tank and apparatus engineering, in ventilation and air conditioning systems, gardening and landscaping, in sanitary installations and in all applications where silicones or products containing silicones are not suitable.

- ▶ 310 ml ▶ 310 ml ▶ 310 ml
- 13700310** **13702310** **13701310**
- white grey black



VIDEO



Assembly Pastes

Lubricants

WEICON TOOLS®

Other

Recoating behavior of 1-Component Elastic Adhesives and Sealants (MS polymers and polyurethanes)

WEICON MS polymers and polyurethanes are basically free of substances which are harmful to the coating composition, such as silicone, and can thus be "recoated".

Various paints and varnishes are widely available, for example:.

- ▶ alkyd resin
- ▶ acrylate resin
- ▶ nitrocombil
- ▶ polymerisate resin paints
- ▶ polyurethane varnishes (DD varnishes)
- ▶ epoxy resin lacquer
- ▶ polyester lacquer

Except for the above-mentioned alkyd resins, all systems are generally suitable. However, in order to test the compatibility with our products, a suitability in preliminary tests must always be determined individually under the respective practical conditions. Due to the different compositions and the diversity of the substrates, this is essential.

It also must be taken into account that not only the immediate first paint layer or lacquer layer, but also all possible intermediate lacquers or top lacquers, have an effect on the bonding and / or sealing.

WEICON polyurethanes:

- ▶ Flex 310 PU
- ▶ Fast-Bond

Painting only after complete curing with suitable colour coating systems.

WEICON MS-polymers

- ▶ Flex 310 M® in the versions: Classic, Crystal, Stainless-steel, Liquid, Super-Tack, HT 200, 2 K
- ▶ Flex+bond®
- ▶ Solar-Flex®, Aqua-Flex®, Speed-Flex®

Recommendation: Directly wet-on-wet, but at the latest within three hours after application of the material. During this period the best adhesion values are achieved. If the adhesive bead is fully cured, pre-treatment should be carried out with e.g. primers (as in the case of plastic coatings).

In general, it must be considered that the curing of the adhesives and sealants is not prevented by a color coating, but will be slowed down.

Elastic Adhesives and Sealants

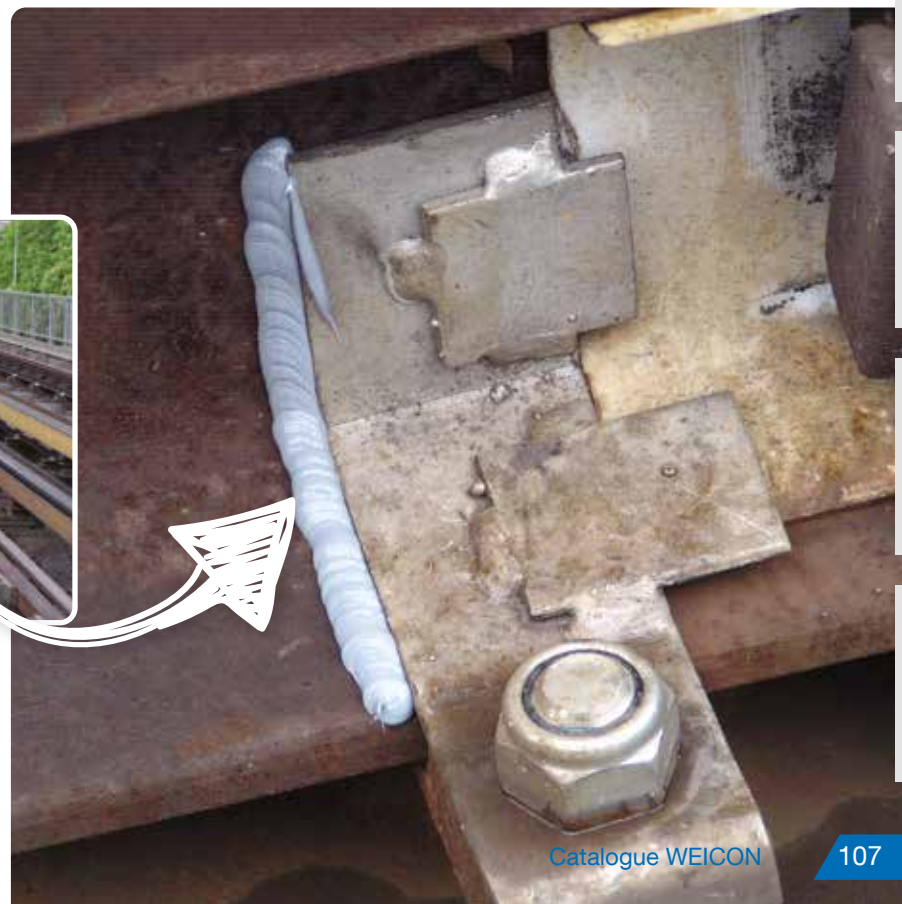

Adhesives / Sealants

Technical Sprays

Technical Liquids

Assembly Pastes

Lubricants

WEICON TOOLS®

Other



Flex 310 PU



Adhesive and sealant based on PU | strong | permanently elastic | ISEGA-certified

WEICON Flex 310 PU Adhesive and Sealant is permanently elastic, strong, paintable, and resistant to weather, UV rays, freshwater and salt water. It is free of silicone.

Flex 310 PU is an elastic adhesive and sealant on Polyurethane basis (PUR) for the bonding and sealing of numerous materials such as metals, plastics, ceramics, wood, glass and stone.

Flex 310 PU can be used in tank and apparatus engineering, carriage, container and vehicle construction, in ventilation and air conditioning systems, the energy and electrical industry and in all applications where silicones or products containing silicones are not suitable.

- ▶ 300 ml ▶ 300 ml ▶ 300 ml
- 13300310** **13301310** **13302310**
- white black grey



Fast-Bond

Fast-curing, 1-component structural and assembly adhesive for universal use on polyurethane basis (PUR)

Fast-Bond Structural and Assembly Adhesive is strong, paintable, sandable, and resistant to weathering, UV rays, freshwater and salt water. It is free of silicone or solvents.

WEICON Fast-Bond is suitable for the bonding of MDF panels, wood panels, chipboards, fibre and plaster boards, concrete, marble, natural and artificial stone, ceramics, gypsum, metals and rigid foams.

- ▶ 310 ml
- 13309310**
- beige

VIDEO



Elastic Adhesives and Sealants

Polyurethanes



Bonding of a skylight
(food truck)
Flex 310 PU



Adhesives / Sealants

Technical Sprays

Technical Liquids

WEICON Cartridge Guns



Cartridge Gun "Special"

- ▶ Professional quality
- ▶ Recommended for medium and high viscosity adhesives
- ▶ Suitable for standard cartridges up to 310 ml

13250002

Compressed Air Cartridge Gun

- ▶ For low and medium viscosity materials (310 ml cartridges)
- ▶ 1,45 kN thrust at 6,8 bar operating pressure

13250009



Dispenser 2C 10:1

- ▶ Recommended for the 2-component 540g cartridge.

10653491

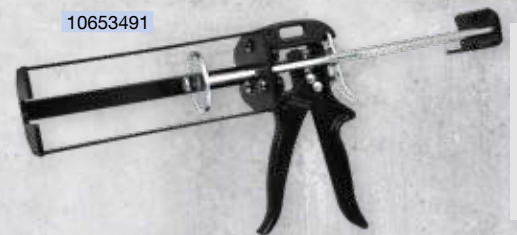

Cartridge Gun "Standard"

- ▶ For low and medium viscosity adhesives
- ▶ Suitable for standard cartridges up to 310 ml.

13250001

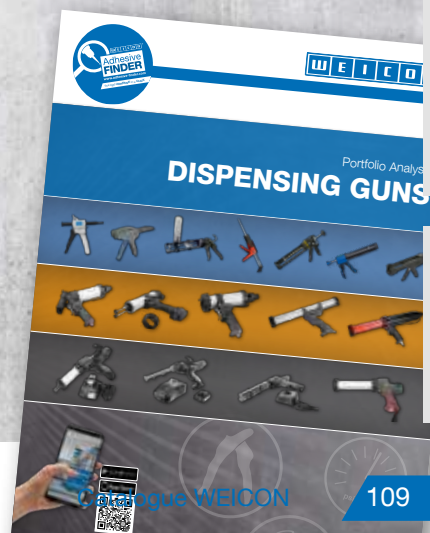

Assembly Pastes

Lubricants

WEICON TOOLS®

Other



Silicone A

Acetoxy curing | fungicidal

WEICON Silicone A Adhesive and Sealant contains no solvents, is acetoxy curing, strong, permanently elastic, resistant to ageing and chemicals, temperature-resistant up to +200°C (+392°F), extremely elastic (breaking elongation >500%) and can be used universally. Silicone A adheres very well to steel, aluminium, glass, ceramics, and many additional materials.

WEICON Silicone A can be used in machine and system construction, ventilation and air conditioning systems, in the energy and electrical industry, in exhibition construction and shopfitting and in many additional industrial applications.



- ▶ 310 ml
13001310
white
- ▶ 310 ml
13002310
grey
- ▶ 310 ml
13003310
black
- ▶ 310 ml
13000310
transparent

Cartridge

Tube

- ▶ 85 ml
13000085
transparent

Silicone F

Liquid | self-levelling | neutral curing

WEICON Silicone F Casting and Sealing compound is liquid, self-levelling, spreadable, free of solvents and neutral curing. It is resistant to weathering and ageing, temperature-resistant up to +180°C (+356°F), extremely elastic (breaking elongation of approx. 370%) and can be used universally.

Silicone F can be specially used for elastic bonds, insulation and impregnation and even for the sealing and casting (max. 10 mm) of technical components. It adheres well to steel, aluminium, glass, ceramics, and many additional materials.

Silicone F can be used in machine and system construction, in plastic processing, the energy and electrical industry, in exhibition construction and shopfitting and in many additional industrial areas.



- ▶ 310 ml
13200310

Silicone LP

Acetoxy curing | drinking water approval

WEICON Silicone LP is an acetoxy curing and permanently elastic adhesive and sealant. It is resistant to chemicals, ageing, weathering and UV radiation as well as to temperatures up to +180°C C (+356°F).

It adheres very well to steel, aluminium, glass, plastics and many other materials. Silicone LP was developed specially for use in sensitive areas. It can be used as sealant in the food and drinking water sector, for example in dairies, slaughterhouses, in the food and beverage production or in canteen kitchens.



Tested by the Ruhr Region Institute of Hygiene ("Hygiene-Institut des Ruhrgebiets") in accordance with the Guideline for Hygienic Assessment of Organic Materials in Contact with Drinking Water (KTW Guideline) by the Federal Environmental Agency of Germany



- ▶ 310 ml
13009310
white
- ▶ 310 ml
13008310
transparent



WEICON Primer E 500

Especially for silicone - for pre-treating non-absorbent surfaces such as aluminium, VA steel, brass, copper, zinc, tinplate and enamel, ceramic and glass as well as plastics such as ABS, PVC hard, PA 6.6, GFC etc.

- ▶ 25 ml
13558002
- ▶ 250 ml
13558025



Elastic Adhesives and Sealants

Silicones

Silicone N

Neutral curing | fungicidal

WEICON Silicone N Adhesive and Sealant is free of solvents, is neutral curing, strong, permanently elastic, resistant to weathering, ageing and chemicals, temperature-resistant up to +180°C (+356°F), extremely elastic (breaking elongation of approx. 800%) and can be used universally.

Silicone N adheres very well to all metals, glass, ceramics, and many additional materials. WEICON Silicone N can be used in plastic processing, the electrical industry, energy technology, the lighting industry, exhibition construction and shopfitting and in many additional industrial areas.



▶ 310 ml
13400310
transparent

HT 300

High-temperature-resistant | acetoxo curing

WEICON HT 300 Adhesive and Sealant is red, high-temperature-resistant (+300°C/+572°F), free of solvents, strong and acetoxo curing. It is resistant to weathering, ageing and chemicals and is extremely elastic (breaking elongation of approx. 300%). HT 300 is particularly suitable for heat-exposed bonds and seals and adheres very well to steel, aluminium, glass, ceramics and many additional materials.

HT 300 can be used in industrial furnaces, flue gas systems, heating installations, exhaust gas routing, heating cabinets and in many additional areas.



Sealing of
heating systems
HT 300



▶ 85 ml
13050085
Tube

▶ 310 ml
13050310
Cartridge

Black-Seal

Extremely resistant against oil and grease

WEICON Black-Seal Adhesive and Sealant is black, high-temperature-resistant (+280°C/+536°F), free of solvents, strong, oil-resistant, grease-resistant, pressure-resistant, resistant to ageing and extremely elastic (breaking elongation of approx. 500%).

Black-Seal is suitable for bonding and sealing in applications where particularly high oil and grease resistance is required. WEICON Black-Seal can be used on gearbox, valve and casing covers, oil sumps, water pumps, gears and axles, flanges, tanks and containers, and in many other areas.

▶ 85 ml ▶ 200 ml ▶ 310 ml
13051085 13051200 13051310
Tube Presspack Cartridge



Flange sealing
Black-Seal

Technical Data

Adhesives / Sealants

Technical Sprays

Technical Liquids

Assembly Pastes

Lubricants

WEICON TOOLS®

Other

WEICON Adhesives and Sealants in non-cured condition										
	Flex 310 M® Classic	Flex 310 M® Crystal	Flex 310 M® HT 200	Flex 310 M® Super-Tack	Flex 310 M® Stainless-steel	Flex 310 M® Liquid	Flex 310 M® Liquid black	Flex 310 M® 2 K	Flex 310 M® ProSeal	Flex 310 M® FireSeal
	✓	✓			✓	✓	✓		✓	
Basis:	1 C.-Polyoxypropylen	1 C.-Polyoxypropylen	1 C.-MS-Polymer	1 C.-MS-Polymer	1 C.-MS-Polymer	1 C.-MS-Polymer	1 K MS-Polymer	2-C Hybrid-Polymer	silane-modified polymer	silane-modified polymer
Colour:	white, grey black	transparent crystal-clear	grey	white, grey	stainless-steel	white	black	grey	grey	concrete-grey
Content/Container:	310 ml	310 ml	310 ml	290 ml	310 ml	310 ml	310 ml	250 ml	310 ml	310 ml
Density g/cm³:	1,44	1,06	1,41	1,62	1,08	1,48	1,00	1,40	1,48	1,47
Viscosity:	pasty	pasty	pasty	pasty	pasty	7.000 mPa.s	20.000 mPa.s	solid paste	pasty	pasty
Stability/Run-off (ASTM D 2202) mm:	1	<1	<1	<1	<1	liquid, self-levelling	self-levelling	-	≤3	≤3
Processing temperature:	+5°C to +40°C ² (+41 to +104°F)	+5°C to +40°C ² (+41 to +104°F)	+5°C to +40°C ² (+41 to +104°F)	+5°C to +40°C ² (+41 to +104°F)	+5°C to +40°C ² (+41 to +104°F)	+5°C to +40°C ² (+41 to +104°F)	+5°C to +40°C ² (+41 to +104°F)	+5 to +35°C (+41 to +95°F)	+5°C to +40°C ² (+41 to +104°F)	+5°C to +40°C ² (+41 to +104°F)
Cure type:	by humidity	by humidity	by humidity	by humidity	by humidity	by humidity	by humidity	chemical polymerisation	by humidity	by humidity
Curing condition:	+5 to +40°C (+41 to +104°F) and 30% to 95% rel. humidity	+5 to +40°C (+41 to +104°F) and 30% to 95% rel. humidity	+5 to +40°C (+41 to +104°F) and 30% to 95% rel. humidity	+5 to +40°C (+41 to +104°F) and 30% to 95% rel. humidity	+5 to +40°C (+41 to +104°F) and 30% to 95% rel. humidity	+5 to +40°C (+41 to +104°F) and 40% to 70% rel. humidity	+5 to +40°C (+41 to +104°F) and 40% to 70% rel. humidity	-	+5 to +40°C (+41 to +104°F) and 30% to 95% rel. humidity	+5 to +40°C (+41 to +104°F) and 30% to 95% rel. humidity
Skin-over time (minutes) ³	25 min.	10 min.	10 min.	10 min.	15 min.	40 min.	160 min.	-	13 min.	12 min.
Cure speed: ³	2-3 mm in the first 24 hours	2-3 mm in the first 24 hours	2-3 mm in the first 24 hours	2-3 mm in the first 24 hours	2-3 mm in the first 24 hours	2-3 mm in the first 24 hours	2-3 mm in the first 24 hours	-	2-3 mm in the first 24 hours	2-3 mm in the first 24 hours
Pot life (at +23°C/+73°F and 50% rel. air humidity)	-	-	-	-	-	-	-	approx. 10 min.	-	-
Set to load bearing	-	-	-	-	-	-	-	approx. 60 min.	-	-
Volume change (DIN 52451) %: ³	-1	-3	-	-2	-1	-9	-	approx. 1%	≤3%	≤3%
Gap filling up to max. mm:	5	5	-	10	5	0,5	-	10	5	5
Gap width up to max. mm:	25	25	-	30	25	25	-	-	40	50
Shelf life in months: +5°C to +25°C (+41 to +77°F)	12	12	12	12	12	12	12	12	18	18

WEICON Adhesives and Sealants in cured condition											
Shore-A-Hardness (DIN ISO 7619):	42	40	55	50	45	43	20	40	76	26	
Elongation at break (DIN EN ISO 527-2) %:	650	300	400	600	280	400	400	350	600	225	
Tensile strength of the pure adhesive/sealant (DIN EN ISO 527-2):	3,3 N/mm² (480 psi)	3,0 N/mm² (440 psi)	3,2 N/mm² (460 psi)	1,9 N/mm² (280 psi)	3,1 N/mm² (450 psi)	2,2 N/mm² (319 psi)	1,5 N/mm² (200 psi)	2,2 N/mm² (319 psi)	1,6 N/mm² (200 psi)	1,5 N/mm² (200 psi)	
Average tensile shear strength (DIN EN 1465 / ASTM D 1002): ⁴	2,1 N/mm² (300 psi)	2,0 N/mm² (290 psi)	1,8 N/mm² (260 psi)	1,5 N/mm² (250 psi)	2,5 N/mm² (360 psi)	1,8 N/mm² (261 psi)	-	1,3 N/mm² (189 psi)	1,4 N/mm² (200 psi)	1,2 N/mm² (170 psi)	
Tear strength (DIN ISO 34-1):	20 N/mm² (114 lb/in)	19 N/mm² (108 lb/in)	21 N/mm² (120 lb/in)	13 N/mm² (74 lb/in)	11 N/mm² (63 lb/in)	11 N/mm² (63 lb/in)	-	-	-	-	
Movement absorption max. %:	15	20	-	20	20	10	-	-	20	20	
Temperature resistance:	-40°C to +90°C (-40 to +194°F) briefly (approx. 2 h) to +130°C (+266°F)	-40°C to +90°C (-40 to +194°F) briefly (approx. 2 h) to +120°C (+248°F)	-40°C to +90°C (-40 to +194°F) briefly (approx. 30 min.) to +200°C (to +392°F)	-40°C to +90°C (-40 to +194°F)	-40°C to +90°C (-40 to +194°F) briefly (approx. 2 h) to +120°C (+248°F)	-40°C to +90°C (-40 to +194°F) briefly (approx. 2 h) to +120°C (+248°F)	-40°C to +90°C (-40 to +194°F) briefly (approx. 2 h) to +120°C (+248°F)	-40°C to +90°C (-40 to +194°F)	-40 to +90°C (-40 to +194°F)	-40 to +90°C (-40 to +194°F)	-40 to +90°C (-40 to +194°F)
Specific forward resistance	1,0 x 10 ¹⁰ Ω-cm	1,2 x 10 ¹² Ω-cm	3,4 x 10 ¹¹ Ω-cm	-	-	1,1 x 10 ¹² Ω-cm	-	-	-	-	
Paintable: ⁵	only "wet-on-wet" within 3 hrs. at the latest after material application with suitable paint coating systems (except alkyd resin paints)	only "wet-on-wet" within 3 hrs. at the latest after material application with suitable paint coating systems (except alkyd resin paints)	only "wet-on-wet" within 3 hrs. at the latest after material application with suitable paint coating systems (except alkyd resin paints)	only "wet-on-wet" within 3 hrs. at the latest after material application with suitable paint coating systems (except alkyd resin paints)	only "wet-on-wet" within 3 hrs. at the latest after material application with suitable paint coating systems (except alkyd resin paints)	only "wet-on-wet" within 3 hrs. at the latest after material application with suitable paint coating systems (except alkyd resin paints)	after complete curing	only "wet-on-wet" within 3 hrs. at the latest after material application with suitable paint coating systems (except alkyd resin paints)	only "wet-on-wet" within 3 hrs. at the latest after material application with suitable paint coating systems (except alkyd resin paints)	only "wet-on-wet" within 3 hrs. at the latest after material application with suitable paint coating systems (except alkyd resin paints)	
Building material category (DIN 4102):	B 2	B 2	B 2	B 2	B 2	B 2	B 2	B 2	E (EN 13501-1)	E (EN 13501-1)	
Possible primers:	see primer selection table on page 115	see primer selection table on page 115	see primer selection table on page 115	see primer selection table on page 115	see primer selection table on page 115	see primer selection table on page 115	see primer selection table on page 115	see primer selection table on page 115	see primer selection table on page 115	see primer selection table on page 115	

² For easier processing, the cartridges, tubes, etc. should be heated to room temperature (+20°/+68°F) before use at low temperatures.
³ Normal climate +23°C (+73°F) and 50% relative humidity in accordance with DIN 50014.
⁴ Material combination aluminium/aluminium, cleaned and degreased with Cleaner S, 1 mm layer thickness, 10 mm per minute tearing speed, fast-bond beech/beech, without pre-treatment, 1 mm layer thickness, 5 mm per minute tearing speed.
⁵ The WEICON One-Component Adhesives and Sealants listed above are free of substances that hinder the coating of lacquer, e.g. silicone. Thanks to the special composition, these can be painted over with suitable paint coating systems (no alkyd resin paints). However, to check the compatibility, suitability must always be determined individually in preliminary tests under the respective real-life conditions. This is essential due to the different compositions and the diversity of the substrates. The curing of the adhesives and sealants is only slightly delayed by a coating of paint.

Elastic Adhesives and Sealants

Technical Data

WEICON Adhesives and Sealants in non-cured condition										
	Aqua-Flex	Solar-Flex®	Windscreen Adhesive	Flex+bond		Flex+bond Liquid	Speed-Flex®	Speed-Flex® Crystal	Flex 310 PU	Fast-Bond
	✓		✓	✓	✓	✓	✓	✓	✓	
Basis:	1 C.-MS-Polymer	1 C.-MS-Polymer	1 C.-Polyoxypropylene	1 C.-MS-Polymer		1 C.-MS-Polymer	1 C.-MS-Polymer	1 C.-MS-Polymer	One-component polyurethane	One-component polyurethane
Colour:	white, grey, black	white, grey	black	white, grey, black	transparent	white	white, grey	transparent	white, grey, black	beige
Content/Container:	310 ml	290 ml	310 ml, 200 ml	200 ml, 85 ml		85 ml	310 ml	310 ml	300 ml	310 ml
Density g/cm ³ :	1,44	1,62	1,44 g/cm ³	1,44	1,06	1,48	1,60	1,06	1,17	1,50
Viscosity:	pasty	pasty	pasty	pasty	pasty	7.000 mPa.s	extremely pasty	pasty	pasty	pasty
Stability/Run-off (ASTM D 2202) mm:	1	<1	1	1	<1	Liquid, self-levelling	<1	<1	1	>1
Processing temperature:	+5°C to +40°C ^{**} (+41 to +104°F)	+5°C to +40°C ^{**} (+41 to +104°F)	+5°C to +40°C ^{**} (+41 to +104°F)	+5°C to +40°C ^{**} (+41 to +104°F)		+5°C to +40°C ^{**} (+41 to +104°F)	+5°C to +40°C ^{**} (+41 to +104°F)	+5°C to +40°C ^{**} (+41 to +104°F)	+5°C to +40°C ^{**} (+41 to +104°F)	+5°C to +40°C ^{**} (+41 to +104°F)
Cure type:	by humidity	by humidity	by humidity	by humidity		by humidity	by humidity	by humidity	by humidity	by humidity
Curing condition:	+5°C to +40°C (+41 to +104°F) and 30% to 95% rel. humidity, Aqua-Flex also hardens under water	+5°C to +40°C (+41 to +104°F) and 30% to 95% rel. humidity, Aqua-Flex also hardens under water	+5 to +40°C (+41 to +104°F) and 30% to 95% rel. humidity	+5°C to +40°C (+41 to +104°F) and 30% to 95% rel. humidity, Aqua-Flex also hardens under water		+5°C to +40°C (+41 to +104°F) and 30% to 95% rel. humidity, Aqua-Flex also hardens under water	+5°C to +40°C (+41 to +104°F) and 30% to 95% rel. humidity, Aqua-Flex also hardens under water	+5°C to +40°C (+41 to +104°F) and 30% to 95% rel. humidity, Aqua-Flex also hardens under water	+5°C to +35°C (+41 to +95°F) and 40% to 70% rel. humidity	see Aqua-, Solar and Speed-Flex
Skin-over time (minutes): ^{**3}	25	10	25	25	10	40	10	10	45	3
Cure speed: ^{**3}	2-3 mm in the first 24 hours	2-3 mm in the first 24 hours	2-3 mm in the first 24 hours	2-3 mm in the first 24 hours		2-3 mm in the first 24 hours	2-3 mm in the first 24 hours	2-3 mm in the first 24 hours	2-3 mm in the first 24 hours	2-3 mm in the first 24 hours
Volume change (DIN 52451) %: ^{**3}	-1	-2	-1	-1	-3	-9	-1	-3	-6	Increase
Gap filling up to max. mm:	5	10	5	5	5	0,5	5	5	5	10
Gap width up to max. mm:	25	30	25	25	25	25	5	25	25	---
Shelf life in months: +5°C to +25°C (+41 to +77°F)	12	12	12	12		12	12	12	9	12
WEICON Adhesives and Sealants in cured condition										
Shore-A-Hardness (DIN ISO 7619):	42	50	42	42	40	43	58	40	45	---
Elongation at break (DIN EN ISO 527-2) %:	650	600	650	650	300	400	230	300	450	---
Tensile strength of the pure adhesive/ sealant (DIN EN ISO 527-2):	3,3 N/mm ² (480 psi)	1,9 N/mm ² (280 psi)	3,3 N/mm ² (480 psi)	3,3 N/mm ² (480 psi)	3,0 N/mm ² (435 psi)	2,2 N/mm ² (319 psi)	2,2 N/mm ² (320 psi)	3,0 N/mm ² (435 psi)	2,0 N/mm ² (290 psi)	10 N/mm ² (1.450 psi)
Average tensile shear strength (DIN EN 1465 / ASTM D 1002): ^{**4}	2,1 N/mm ² (300 psi)	1,5 N/mm ² (250 psi)	2,1 N/mm ² (300 psi)	2,1 N/mm ² (300 psi)	2,0 N/mm ² (290 psi)	1,8 N/mm ² (261 psi)	1,3 N/mm ² (190 psi)	2,0 N/mm ² (290 psi)	1,6 N/mm ² (230 psi)	11 N/mm ² (1.595 psi)
Tear strength (DIN ISO 34-1):	20 N/mm ² (114 lb/in)	13 N/mm ² (74 lb/in)	20 N/mm ² (114 lb/in)	20 N/mm ² (114 lb/in)	19 N/mm ² (108 lb/in)	11 N/mm ² (63 lb/in)	10 N/mm ² (57 lb/in)	19 N/mm ² (108 lb/in)	9 N/mm ² (51 lb/in)	---
Movement capacity max. %:	15	20	15	15	20	10	15	20	10	---
Temperature resistance:	-40°C to +90°C (-40 to +194°F) briefly (approx. 2 h) to +130°C (+266°F)	-40°C to +90°C (-40 to +194°F)	-40°C to +90°C (-40 to +194°F) briefly (approx. 2 h) to +130°C (+266°F)	-40°C to +90°C (-40 to +194°F)	-40°C to +90°C (-40 to +194°F)	-40°C to +80°C (-40 to +176°F) briefly. (approx. 2 h) to +120°C (+248°F)	-40°C to +80°C (-40 to +176°F) briefly. (approx. 2 h) to +120°C (+248°F)	-40°C to +90°C (-40 to +194°F) briefly (approx. 2 h) to +120°C (+248°F)	-40°C to +90°C (-40 to +194°F) briefly (approx. 2 h) to +120°C (+248°F)	-30°C to +100°C (-22 to +212°F)
Specific forward resistance	-	-	1,0 x 10 ¹⁰ Ω·cm	-	-	1,1 x 10 ¹² Ω·cm	1,4 x 10 ¹¹ Ω·cm	0,9 x 10 ¹² Ω·cm	-	-
Paintable: ^{**5}	only „wet-on-wet“, within 3 hours at the latest after material application with suitable paint coating systems (except alkyd resin paints)	only „wet-on-wet“, within 3 hours at the latest after material application with suitable paint coating systems (except alkyd resin paints)	only „wet-on-wet“ within 3 hrs. at the latest after material application with suitable paint coating systems (except alkyd resin paints)	only „wet-on-wet“, within 3 hours at the latest after material application with suitable paint coating systems (except alkyd resin paints)		after complete curing	only „wet-on-wet“, within 3 hours at the latest after material application with suitable paint coating systems (except alkyd resin paints)	only „wet-on-wet“, within 3 hours at the latest after material application with suitable paint coating systems (except alkyd resin paints)	after complete curing	after complete curing
Building material category (DIN 4102):	B 2	B 2	B 2	B 2		B 2	B 2	B 2	B 2	B 2
Possible primers:	see primer selection table on page 115	see primer selection table on page 115	see primer selection table on page 115	see primer selection table on page 115		see primer selection table on page 115	see primer selection table on page 115	see primer selection table on page 115	see primer selection table on page 115	---

Adhesives / Sealants

Technical Sprays

Technical Liquids

Assembly Pastes



Lubricants

WEICON TOOLS®

Other



Technical Data

WEICON Adhesives and Sealants in non-cured condition						
	Silicone A	Silicone LP*	Silicone N	Silicone F	HT 300	Black-Seal
 		✓				
Basis:	1-C Polysiloxane (acetate)	1-C Polysiloxane (acetate)	1-C Polysiloxane (pentanonoxime)	1-C Polysiloxane (pentanonoxime)	1-C Polysiloxane (acetate)	1-C Polysiloxane (acetate)
Density (g/cm ³):	1,03	1,00	1,01	1,00	1,18	1,04
Viscosity:	pasty	pasty	pasty	30.000 mPas	pasty	pasty
Stability/Run-off (ASTM D 2202) mm:	1	1	1	liquid	1	>1
Processing temperature:	+5°C to +35°C ^{**} (+41 to +95°F)	+5°C to +35°C ^{**} (+41 to +95°F)	+5°C to +35°C ^{**} (+41 to +95°F)	+5°C to +35°C ^{**} (+41 to +95°F)	+5°C to +35°C ^{**} (+41 to +95°F)	+5°C to +35°C ^{**} (+41 to +95°F)
Cure type:	by humidity	by humidity	by humidity	by humidity	by humidity	by humidity
Curing condition:	+5°C to +40°C (+41 to +104°F) and 30% to 95% rel. humidity	+5°C to +40°C (+41 to +104°F) and 30% to 95% rel. humidity	+5°C to +40°C (+41 to +104°F) and 30% to 95% rel. humidity	+5°C to +40°C (+41 to +104°F) and 30% to 95% rel. humidity	+5°C to +40°C (+41 to +104°F) and 30% to 95% rel. humidity	+5°C to +40°C (+41 to +104°F) and 30% to 95% rel. humidity
Skin-over time (minutes): ^{**3}	15	10	7	15	8	7
Cure speed: ^{**3}	2-3 mm in the first 24 hours	2-3 mm in the first 24 hours	2-3 mm in the first 24 hours	2-3 mm in the first 24 hours	2-3 mm in the first 24 hours	2-3 mm in the first 24 hours
Volume change (DIN 52451) %: ^{**3}	< -6 %	< -6 %	< -6 %	-9 %	< -6 %	< -6 %
Gap filling up to max. mm:	5	5	5	2	5	5
Gap width up to max. mm:	25	25	25	---	25	25
Shelf life in months: +5°C to +25°C (+41 to +77°F)	15	12	12	12	12	12
WEICON Adhesives and Sealants in cured condition						
Shore-A-Hardness (DIN 53505 / ASTM D 2240):	20	25	20	10	30	37
Elongation at break ISO 37, S3A [%]	700	575	550	600	300	470
Tensile strength ISO 37, S3A [N/mm ²]	1,4 N/mm ² (200 psi)	1,4 N/mm ² (200 psi)	1,5 N/mm ² (220 psi)	1,8 N/mm ² (260 psi)	2,5 N/mm ² (360 psi)	2,2 N/mm ² (320 psi)
Tension strength value at 100 % nach ISO 37, S3A	0,3 N/mm ² (40 psi)	0,5 N/mm ² (70 psi)	0,4 N/mm ² (60 psi)	0,2 N/mm ² (30 psi)	0,9 N/mm ² (130 psi)	0,7 N/mm ² (100 psi)
Movement capacity max. %:	25	25	25	/	15	15
Fungicide:	yes	no	yes	no	no	no
Temperature resistance:	-40°C to +180°C (-40 to +356°F)	-40°C to +180°C (-40 to +356°F)	-40°C to +180°C (-40 to +356°F)	-50°C to +180°C (-58 to +356°F)	-40°C to +280°C (-40 to +536°F) briefly (approx. 2 h) +300°C (+572°F)	-40°C to +280°C (-40 to +536°F) briefly (approx. 2 h) +300°C (+572°F)
Paintable:	cannot be painted	cannot be painted	cannot be painted	cannot be painted	cannot be painted	cannot be painted
Building material category (DIN 4102):	B 2	B 2	B 2	B 2	B 2	B 2

^{**} For easier processing, the cartridges should be heated to room temperature (+20°/+68°F) before use at low temperatures.

^{**3} Normal climate +23°C (+73°F) and 50% relative humidity in accordance with DIN 50014.

Elastic Adhesives and Sealants

Information on surface preparation/pre-treatment

Material		Basis MS-Polymere (POP)	Basis Polyurethane (PUR)	Basis Silicone
ABS		Surface Cleaner + K 200	Surface Cleaner + K 200	Surface Cleaner + K 200
Aluminium	Bare	Surface Cleaner + M 100	Surface Cleaner + roughening up + M 100	Surface Cleaner + roughening up + E 500
	Chromated	Surface Cleaner	Surface Cleaner	Surface Cleaner
	Anodised	Surface Cleaner + M 100	Surface Cleaner + M 100	Surface Cleaner + E 500
	Powder-coated	Surface Cleaner + K 200*	Surface Cleaner + K 200*	Surface Cleaner + K 200*
	Primed	Surface Cleaner + K 200*	Surface Cleaner + K 200*	Surface Cleaner + K 200*
	Painted	Surface Cleaner + K 200*	Surface Cleaner + K 200*	Surface Cleaner + K 200*
Enamel		Surface Cleaner + M 100	Surface Cleaner + M 100	Surface Cleaner + E 500
EPDM		Surface Cleaner + P 400*	Surface Cleaner + P 400*	Surface Cleaner + P 400*
GFRP (polyester, epoxy)	Smooth/rough side	Surface Cleaner + K 200	Surface Cleaner + K 200	Surface Cleaner + E 500
	Web goods	Surface Cleaner + K 200	Surface Cleaner + K 200	Surface Cleaner + E 500
	Hand laminate	Surface Cleaner + K 200	Surface Cleaner + K 200	Surface Cleaner + E 500
Glass	Untreated, clear	Surface Cleaner	Surface Cleaner + M 100**	Surface Cleaner + E 500
	Ceramic-coated	Surface Cleaner + M 100	Surface Cleaner + M 100	Surface Cleaner + E 500
Wood	Phenol-coated	no adhesion	Surface Cleaner + roughening up + M 100	Surface Cleaner + roughening up + E 500
	Melamine-coated	Surface Cleaner + K 200	Surface Cleaner + K 200	Surface Cleaner + E 500
	Untreated	Clean with humid cloth + Primer S 300	Blow off with compressed air + Primer S 300	Clean with humid cloth + Primer S 300
Ceramic		Surface Cleaner + M 100	Surface Cleaner + M 100	Surface Cleaner + E 500
Copper		Surface Cleaner + roughening up + M 100	Surface Cleaner + roughening up + M 100	Surface Cleaner + roughening up + E 500
Brass		Surface Cleaner + roughening up + M 100	Surface Cleaner + roughening up + M 100	Surface Cleaner + roughening up + E 500
PA (polyamide)		Surface Cleaner + K 200	Surface Cleaner + K 200	Surface Cleaner + E 500
PC *2		Surface Cleaner + K 200*	Surface Cleaner + K 200*	Surface Cleaner + K 200*
PIR hard foam (polyisocyanurate)		Surface Cleaner	Surface Cleaner	Surface Cleaner
PMMA (acrylic glass)		Surface Cleaner + K 200*	Surface Cleaner + K 200*	Surface Cleaner + K 200*
Polywood		Roughen up finely + Surface Cleaner	Roughen up finely + Surface Cleaner	Roughen up finely + Surface Cleaner
PP/PE		Surface Cleaner + P 400*	Surface Cleaner + P 400	Surface Cleaner + P 400*
PS	Hard foam	Surface Cleaner + P 400*	Surface Cleaner + P 400*	Surface Cleaner + P 400*
	Panels, impact-resistant	Surface Cleaner	Surface Cleaner	Surface Cleaner
PUR hard foam (polyurethane)		Surface Cleaner	Surface Cleaner	Surface Cleaner
PUR elastomer		Surface Cleaner	Surface Cleaner	Surface Cleaner
PVC	Panels	Surface Cleaner + K 200	Surface Cleaner + K 200	Surface Cleaner + E 500
	Hard foam	Surface Cleaner	Surface Cleaner + K 200	Surface Cleaner + E 500
Steel	Bare	Surface Cleaner	Surface Cleaner	Surface Cleaner
	Chromated	Surface Cleaner	Surface Cleaner	Surface Cleaner
	Primed	Surface Cleaner + K 200	Surface Cleaner + M 100	Surface Cleaner + E 500
	Painted	Surface Cleaner + K 200	Surface Cleaner + M 100	Surface Cleaner + E 500
	Powder-coated	Surface Cleaner + K 200	Surface Cleaner + M 100	Surface Cleaner + E 500
	VA (stainless steel)	Surface Cleaner + roughening up + M 100	Surface Cleaner + roughening up + M 100	Surface Cleaner + roughening up + E 500
	Galvanised	Surface Cleaner + roughening up + M 100	Surface Cleaner + roughening up + M 100	Surface Cleaner + roughening up + E 500

* Preliminary tests are required

** Protect against UV back radiation

*2 Protect from UV radiation

Primer M 100: For pretreating non-absorbent surfaces, e.g. metals, plastics, painted surfaces, enamels, ceramic and coated glass.

Primer K 200: For pretreating non-absorbent and painted plastic surfaces and elastomers, e.g. EPDM.

Primer S 300: For pretreating porous and absorbent surfaces.

Primer P 400: For pretreating polyolefins, e.g. PE, PP and difficult-to-bond elastomers.

Primer E 500: For pre-treating silicones.

Chemical resistance of WEICON Adhesives and Sealants after curing

	Flex 310 M® Classic	Flex 310 M® Crystal	Flex 310 M® HT 200	Flex 310 M® Super-Tack	Flex 310 M® Stainless-steel	Flex 310 M® 2 K	Flex 310 M® Liquid	Flex 310 M® Liquid black	Windscreen Adhesive	Flex+bond®	Speed-Flex®	Speed-Flex® Crystal	Flex 310 M® ProSeal	Flex 310 M® FireSeal	Aqua-Flex	Solar-Flex®	Flex 310 PU	Fast-Bond	Silicone A	Silicone LP	Silicone N	Silicone F	HT 300	Black-Seal
Acetone	-	-	-	-	-	-	-	-	-	-	-	-	-	-	-	-	-	-	+	+	o	o	+	+
Alcohol	o	o	o	o	o	o	o	o	o	o	o	o	o	o	o	o	o	o	+	+	+	+	+	+
Concentrated formic acid	-	-	-	-	-	-	-	-	-	-	-	-	-	-	-	-	-	-	o	o	o	o	+	+
Ammonia 10 %	+	o	+	+	+	+	+	+	+	o	+	o	+	+	+	+	+	o	+	+	+	+	+	+
Petrol (92 to 100 octane)	-	-	-	-	-	-	-	-	-	-	-	-	-	-	-	-	-	-	+	+	o	o	+	+
Diesel/heating oil	-	-	-	-	-	-	-	-	-	-	-	-	-	-	-	-	-	-	o	o	-	-	+	+
Glycol ether	-	-	-	-	-	-	-	-	-	-	-	-	-	-	-	-	-	-	+	+	+	+	+	+
Ethanol	-	-	-	-	-	-	-	-	-	-	-	-	-	-	-	-	-	-	+	+	+	+	+	+
Freon	-	-	-	-	-	-	-	-	-	-	-	-	-	-	-	-	-	-	o	o	-	-	+	+
Antifreeze	+	+	+	+	+	+	+	+	+	+	+	+	+	+	+	+	+	+	+	+	+	+	+	+
Gear oil	-	-	-	-	-	-	-	-	-	-	-	-	-	-	-	-	-	-	o	o	-	-	+	+
Glycerine (glycol)	+	o	+	+	+	+	+	+	+	+	+	o	+	+	+	+	+	+	+	+	+	+	+	+
Hexane	-	-	-	-	-	-	-	-	-	-	-	-	-	-	-	-	+	+	+	+	o	+	+	+
Hydraulic oil	o	-	o	o	o	o	o	o	o	o	o	-	o	o	o	o	o	o	+	+	+	+	+	+
Caustic potash solution 20%	o	o	o	o	o	o	o	o	o	o	o	o	o	o	o	o	+	+	-	-	-	-	-	-
Cooling lubricant, water-dilutable	+	o	+	+	+	+	+	+	+	+	+	o	+	+	+	+	+	+	+	+	+	+	+	+
Lyes, diluted	+	+	+	+	+	+	+	+	+	+	+	+	+	+	+	+	+	+	+	+	+	+	+	+
Methanol	-	-	-	-	-	-	-	-	-	-	-	-	-	-	-	-	-	-	+	+	o	o	+	+
Methyl ethyl ketone	-	-	-	-	-	-	-	-	-	-	-	-	-	-	-	-	-	-	+	+	o	o	+	+
Motor oil, mineral and synthetic	-	-	-	-	-	-	-	-	-	-	-	-	-	-	-	-	-	-	+	+	o	o	+	+
Sodium hydroxide solution 20%	-	-	-	-	-	-	-	-	-	-	-	-	-	-	-	-	o	o	+	+	o	o	+	+
Phosphoric acid 5%	-	-	-	-	-	-	-	-	-	-	-	-	-	-	-	-	-	-	+	+	o	o	+	+
2-propanol	-	-	-	-	-	-	-	-	-	-	-	-	-	-	-	-	o	o	+	+	o	o	+	+
Nitric acid 5%	-	-	-	-	-	-	-	-	-	-	-	-	-	-	-	-	-	-	+	+	o	o	+	+
Hydrochloric acid 5%	-	-	-	-	-	-	-	-	-	-	-	-	-	-	-	-	-	-	+	+	o	o	+	+
Salt water/seawater	+	-	+	+	+	+	+	+	+	+	+	+	+	+	+	+	+	+	+	+	+	+	+	+
Sulphuric acid 5%	-	-	-	-	-	-	-	-	-	-	-	-	-	-	-	-	-	-	+	+	o	o	+	+
Edible oil/vegetable oil	o	o	o	o	o	o	o	o	o	o	o	o	o	o	o	o	o	o	+	+	+	+	+	+
Toluene	-	-	-	-	-	-	-	-	-	-	-	-	-	-	-	-	-	-	+	+	o	o	+	+
Benzene	-	-	-	-	-	-	-	-	-	-	-	-	-	-	-	-	-	-	+	+	o	o	+	+
Water	+	+	+	+	+	+	+	+	+	+	+	+	+	+	+	+	+	+	+	+	+	+	+	+
Water, +90°C (+194°F)	+	-	+	+	-	+	+	+	+	+	+	-	+	+	+	+	-	-	+	+	+	+	+	+
Hydrogen peroxide 3%	+	-	+	+	+	+	+	+	+	+	+	-	+	+	+	+	-	-	+	+	+	+	+	+
Paraffin oil	-	-	-	-	-	-	-	-	-	-	-	-	-	-	-	-	-	-	+	+	+	+	+	+
Xylene	-	-	-	-	-	-	-	-	-	-	-	-	-	-	-	-	-	-	+	+	o	o	+	+
Citric acid 10%	-	-	-	-	-	-	-	-	-	-	-	-	-	-	-	-	-	-	+	+	+	+	+	+

+ = resistant o = limited resistance - = not resistant

Formula for calculating the consumption quantity

Joint depth \ Joint width	5 mm		6 mm		8 mm		10 mm		12 mm	
	ml/m	m/Kart.	ml/m	m/Kart.	ml/m	m/Kart.	ml/m	m/Kart.	ml/m	m/Kart.
5 mm	25	12,4	30	10,3						
6 mm	30	10,3	36	8,6						
8 mm	40	7,75	48	6,5	64	4,8				
10 mm	50	6,2	60	5,2	80	3,9	100	3,1		
12 mm	60	5,2	72	4,3	96	3,2	119	2,6		
15 mm	75	4,1	90	3,4	120	2,6	148	2,1	182	1,7
18 mm			108	2,9	144	2,2	182	1,7	221	1,4
20 mm					160	1,9	194	1,6	240	1,3
25 mm							258	1,2	300	1,0

Conversions



(°C x 1,8) + 32 = °F
 kV/mm x 25,4 = V/mil
 mm / 25,4 = inches
 µm / 25,4 = mil
 N x 0,225 = lb
 N/mm x 5,71 = lb/in
 N/mm x 5,71 = pli
 N/mm² x 145 = psi

MPa x 145 = psi
 MPa x 0,145 = KSI
 mPa·s = cP
 N·m x 8,851 = lb·in
 N·m x 0,738 = lb·ft
 N·mm x 0,142 = oz·in
 kg x 2,2046 = lb

Elastic Adhesives and Sealants

WEICON Primer M 100

▶ 250 ml 13550125 ▶ 25 ml 13550102

For pre-treating non-absorbent metal surfaces (aluminium, steel, stainless steel, brass, copper, zinc, tinplate), plastics (ABS, rigid PVC, PA 6.6, FRP, SMC, PUR), lacquered surfaces, enamel, ceramic, and glass.



WEICON Primer K 200

▶ 250 ml 13550225 ▶ 25 ml 13550202

For pre-treating non-absorbent and lacquered surfaces, plastic materials (ABS, rigid PVC, PA 6.6, FRP, SMC, PUR), metals (aluminium, steel, stainless steel, brass, zinc, tinplate) and elastomers (EPDM).



WEICON Primer S 300

▶ 250 ml 13550325 ▶ 25 ml 13550302

For pre-treating absorbent and/or porous surfaces, like e.g. uncoated hardboards and plasterboards.



WEICON Primer P 400

▶ 250 ml 13550425 ▶ 25 ml 13550402

For pre-treating non-absorbent low-energy surfaces, like e. g. plastics (PE, PP, TPE) and elastomers (EPDM).



WEICON Primer E 500

▶ 250 ml 13558025 ▶ 25 ml 13558002

Especially for silicone - for pre-treating non-absorbent surfaces such as aluminium, VA steel, brass, copper, zinc, tinplate and enamel, ceramic and glass as well as plastics such as ABS, PVC hard, PA6.6, GFC etc.



Primer Applicator

13955050



For application of WEICON Primer.

Primer

Bonding agent

Even without the use of a primer, WEICON Elastic Adhesives and Sealants (on the basis of MS and hybrid polymers) achieve good bonding results on most material surfaces.

Smoothing Agent

Simple smoothing of many sealants

The Smoothing Agent is a transparent mixture of non-ionic surface activators. Applying it makes it possible to easily and cleanly smooth off all WEICON Elastic Adhesives and Sealants such as silicone, MS polymers, polyurethane, etc. prior to skin formation.

▶ 500 ml 13559500 ▶ 5 L 13559505
Spray bottle



Technical Data

	M 100	K 200	S 300	P 400	E 500
Basis:	Synthetic resin, with solvents	Synthetic resin, with solvents	Polyurethane, with solvents	Rubber, with solvents and chloric	Silicone resin, contains solvent
Colour	colourless, transparent	colourless,	yellowish, transparent	amber, transparent	slightly yellowish, transparent
Content	250 ml, 25 ml	250 ml, 25 ml	250 ml, 25 ml	250 ml, 25 ml	250 ml, 25 ml
Density (g/cm ³):	0,79	0,77	1,03	0,80	0,78
Consumption per m ² (ml):	20 - 40	20 - 40	80 - 200	20 - 60	100
Processing temperature:	+10°C to +25°C (+50°F to +77°F)	+10°C to +35°C (+50°F to +95°F)	+5°C to +25°C (+41°F to +77°F)	-15°C to +35°C (+5°F to +95°F)	+10°C to +25°C (+50°F to +77°F)
Evaporation time (min):	approx. 10	approx. 10	approx. 60	approx. 10 - 60	approx. 60
Period of use (hrs.):	24	24	4	1	8
Suited for	WEICON Adhesives and Sealants (except Silicones) WEICON Urethane	WEICON Adhesives and Sealants (except Silicones) WEICON Urethane	WEICON Adhesives and Sealants (except Silicones) WEICON Urethane	WEICON Adhesives and Sealants (except Silicones) WEICON Urethane	WEICON Silicone A, F and N WEICON HT-300 WEICON Black-Seal



For an optimum result, the surfaces to be bonded must be clean (Surface Cleaner), dry and as smooth as possible. The processing temperature should be above +10°C (+50°F).

Mounting Tape is not suitable for wallpapers or other sensitive surfaces. A removal of the tape may cause damage to the substrate.



Transparent

Moisture-resistant | UV-resistant | strong

- ▶ load bearing capacity 80 kg/m
- ▶ 19 mm x 3 m (length x width)
- ▶ core size 40 mm



WEICON Mounting Tape Transparent is a double-sided, highly transparent adhesive tape made of pure acrylate adhesive. The tape is particularly suitable for visually demanding structural joints where transparent components need to be bonded permanently both for indoor and outdoor use.

The transparent adhesive tape adheres firmly and securely to almost all smooth surfaces, such as glass, plastics, steel, aluminum, or tiles. The tape works in a temperature range of -40°C to +160°C (-40°F to +320°F) and is UV- and moisture-resistant. In combination with WEICON Adhesives and Sealants, it can be used as a fixing aid for hybrid bonding and ensures the secure positioning of the parts to be bonded.

Mounting Tape Transparent can be used in many different sectors, such as the advertising technology, fair and exhibition construction, kitchen and furniture construction, the caravanning sector, car body and vehicle construction, metal construction and in the electronics industry.

14100319
Length 3 m

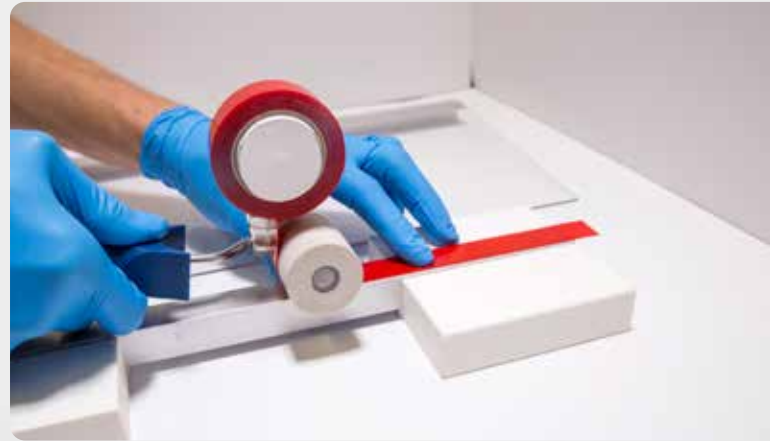

Adhesives / Sealants

Technical Sprays

Technical Liquids

Assembly Pastes

Lubricants

WEICON TOOLS®

Other



Fixing aid in combination with WEICON Adhesives and Sealants.



Mounting Tape

Grey

Extremely strong adhesion | for smooth surfaces | high flexibility

- ▶ load bearing capacity 85 kg/m
- ▶ 19 mm x 3 m (length x width)
- ▶ core size 40 mm



Mounting Tape Grey is a strong, double-sided adhesive tape made of modified acrylic foam. The tape is particularly suitable for the bonding of low-energy plastics, such as PE and PP, as well as for powder-coated surfaces. In combination with WEICON adhesives and sealants, it can be used as a fixing aid for hybrid bonding.

The high flexibility of the tape perfectly compensates tensions when bonding around corners. Mounting Tape Grey has a temperature resistance of -40°C to +120°C (-40°F to +248°F), is UV- and moisture-resistant and suitable for permanent joints both indoors and outdoors.

Mounting Tape Grey can be used in a variety of applications in many sectors, such as car body and vehicle technology, caravanning, metal and apparatus engineering, electronics, mechanical engineering, advertising, shipbuilding and marine technology.

14050319

Length 3 m



Technical Data

	Transparent	Grey
Thickness	0,5 mm	0,9 mm
Elongation at break	750%	750%
Tensile strength	9 N/cm	10 N/cm
Adhesion to steel*	20 N/cm	20 N/cm
T-Block tensile strength to aluminium*	80 N/cm ²	50 N/cm ²
Dynamic shear strength**	40 N/cm ²	45 N/cm ²
Static shear strength**	> 10.000 min	> 10.000 min
Temperature range	-40°C to +160°C (-40°F to +320°F)	-40°C to +120°C (-40°F to +248°F)

*72 h **+23°C and +70°C, 1000 g, 625 mm²

Contact adhesives for bonding rubber and metal

WEICON CONTACT ADHESIVES

What are contact adhesives?

Contact adhesives belong to the group of physically setting adhesives. These are adhesives that cure without a complex chemical reaction. The adhesive is activated and cures simply by the solvent flashing off. In contrast, with chemically setting adhesives, the adhesive is formed by the chemical reaction of polyaddition, polycondensation or polymerisation.

With the GMK (rubber-metal) adhesives, WEICON offers contact adhesives as 1-component (GMK 2410) and 2-component (GMK 2510) version.

What are contact adhesives used for?

Contact adhesives are needed wherever high initial strength is required and the bond should be permanently elastic and moisture-resistant.

WEICON GMK Adhesives are preferably used for the bonding of rubber materials to each other and to metal surfaces.



GMK 2510

Strong | permanently elastic | temperature-resistant

GMK 2510 is a 2-component adhesive based on polychloroprene for full-surface and permanently elastic bonding of parts which are continuously exposed to dynamic loads. The advantage compared to 1-component contact adhesives is the considerably better adhesion and the improved temperature resistance.

GMK 2510 bonds rubber, metal, textiles, leather, sponge rubber (neoprene), CSM (Hypalon), insulating materials, PU materials with an adhesive coating, wood and many plastics. After curing the bonding is moisture-proof. WEICON GMK 2510 is not suitable for materials such as polystyrene foam, polyethylene, polypropylene parts, PVC soft foam and PVC imitation leather.

▶ 324 g

16200324

Working package
(consisting of 300 g adhesive and
24 g activator)

▶ 690 g

16200690

Working package
(consisting of 650 g adhesive
and 40 g activator)

Rubber Metal Adhesive

GMK 2410 GMK 2510

GMK 2410

Permanently elastic | resistant to humidity

GMK 2410 is an adhesive based on polychloroprene (CR) for the high-strength, full-surface and flexible bonding of

- rubber to rubber
- rubber to metal

WEICON GMK 2410 also bonds cellular rubber (e. g. neoprene), leather, felt, insulating material, textiles, wood, and many plastics.

GMK 2410 is not suitable for materials such as expanded polystyrene, polyethylene, polypropylene, flexible PVC foam, and artificial PVC leather. The product can be used for many industrial applications.

- | | | |
|-----------------------------|------------------------------|-------------------------------------|
| ▶ 185 g
16100185
Tube | ▶ 300 g
16100300
Can | ▶ 350 g
16100350
Brushtop can |
| ▶ 700 g
16100700
Can | ▶ 5 kg
16100905
Bucket | ▶ 25 kg
16100925
Bucket |



Adhesives / Sealants

Technical Data

	GMK 2410	GMK 2510
Basis:	Polychloroprene (CR)	Polychloroprene (CR)
Density:	0,93 g/cm ³	0,85 g/cm ³
Viscosity:	approx. 2.400 mPa·s	1.500 mPa·s
Mixing ratio:	---	100:7
Colour:	yellowish-brown	black
Consumption:	250 – 350 g/m ²	150 - 300 g/m ²
Evaporation time:	5 – 10 minutes	5 – 15 minutes
Final strength:	approx. 24 hours	approx. 24 hours
Temperature range:	from -40°C to +80°C (-40°F to +176°F)	from -40°C to +80°C (-40°F to +176°F), short-term (1 h) to +130°C (+266°F)
Processing temperature:	+15°C to +35°C (+59°F to 95°F)	+15°C to +35°C (+59 to +95°F), the adhesive gels under +5°C (+41°F), however is ready to use again by carefully heating it to room temperature!
Shelf life:	12 months when unopened	12 months when unopened
Storage:	at room temperature (+15°C to +25°C/+59 to 77°F) dry, in tightly closed container	at room temperature (+15°C to +25°C/+59 to 77°F) dry, in tightly closed container

Medium tensile shear strength

	GMK 2410	GMK 2510
Galvanised steel / EPDM:	0,16 N/mm ² (16,0 N/cm ² *) 23 psi	0,60 N/mm ² (60,0 N/cm ² *) 87 psi
Galvanised steel / galvanised steel:	1,60 N/mm ² (160,0 N/cm ² *) 232 psi	3,00 N/mm ² (300,0 N/cm ² *) 435 psi
Galvanised steel / SBR:	0,54 N/mm ² (54,0 N/cm ² *) 78 psi	0,50 N/mm ² (50,0 N/cm ² *) 72 psi
Galvanised steel / NBR:	0,57 N/mm ² (57,0 N/cm ² *) 83 psi	0,49 N/mm ² (49,0 N/cm ² *) 71 psi

* Tensile shear test in accordance with DIN EN 1465

Surface and Anti-Corrosion Coatings

Product	Page
Zinc Spray	124
Zinc Spray bright grade	124
Zinc-Alu-Spray	124
Galva Spray	125
Rust Protection 2000 PLUS	126
Aluminium-Spray A-100	126
Aluminium-Spray A-400	126
Stainless Steel Spray	127
Stainless Steel Spray bright grade	127
Chrome-Silver Spray	128
Isolation Spray	128
Copper Spray	128
Corro-Protection	129
Gold Spray	129
Brass Spray	129

Cleaners and Degreasers

Cleaner Spray S	132
Fast Cleaner	132
Industrial Cleaner	133
Surface Cleaner	133
Plastic-Cleaner	133
Brake Cleaner	133
Burner Cleaner	134
Mould Cleaner	134
Parts and Assembly Cleaner	134
Multi-Foam	135
Citrus Cleaner	135
Foam Cleaner	135
Electro Contact Cleaner	136
Sealant and Adhesive Remover	136
Compressed-Air Spray	136
Visor Cleaner	137
Screen Cleaner	137

Protection and Care

Stainless Steel Care Spray	138
Stainless Steel Care Spray A7	138
Metal-Fluid	138
Cockpit-Spray	138
Belt Dressing Spray	139
Hand Protective Foam	139

Solvents and Release Agents

Product	Page
Rust Shock	140
Rust Converter	140
Rust Loosener Fluid	141
Rust Loosener & Contact Spray	141
Contact Spray	141
Label Remover	142
Chewing Gum Remover	142
Mould Release Agent	142
Alu Grinding Protection	143
Anti-Spatter Spray	143
Ceramic Anti-Spatter Spray	143

Lubricating and Multifunctional Oils

W 44 T® Multi-Spray	144
W 44 T® -Fluid	144
AT-44 Allround-Spray	145
Bio-Cut	145
Bio-Fluid	145
Pneuma Lube	146
Silicone Spray	146
Silicone-Fluid	146
Fitting Spray	146
PTFE-Spray	147
PTFE-Fluid	147
Anti-Friction Spray MoS ₂	147

Adhesive Lubricants and Grease Sprays

Top-Lube	148
Top-Lube-Fluid	148
Chain and Rope Lube Spray	148
Spray-on Grease with MoS ₂	148
Spray-on Grease white	149
Adhering Grease - extra strong	149
Spray-on Grease H1	149

Assembly Sprays

Anti-Seize Assembly Spray ASA 400	150
Anti-Seize Assembly Spray ASW 400	150
Copper Paste Assembly Spray KPS 400	150

Adhesive Sprays

Adhesive Spray - extra strong -	151
Adhesive Spray	151
Adhesive Spray - for detachable joints -	151

Adhesives / Sealants
Technical Sprays
Technical Liquids
Assembly Pastes
Lubricants
WEICON TOOLS®
Other

Technical Sprays



WEICON – Our name stands for high-quality products that have been used successfully in all areas of production, repair, maintenance, and servicing for many years. Products that will certainly solve a number of tasks and problems in your company as well.

Constant further development and adaptation to the latest requirements from practice and environmental concerns also guarantee a quality standard that remains consistently high.

- ▶ Surface and Anti-Corrosion Coatings
- ▶ Cleaners and Degreasers
- ▶ Protection and Care
- ▶ Solvents and Release Agents
- ▶ Lubricants

Find the right cleaner



Special Sprays

Leak Detection Sprays	152
Crack Testing Agent	153
Allround Sealing Spray	154
Smoke Detector Test Spray	155
Smoke Detector Test Spray non-flammable	155
Starter Spray	155
Freeze Spray	155

Technical Sprays for Sensitive Areas

NSF-Sprays  156-157



VIDEO

Adhesives / Sealants
 Technical Sprays
 Technical Liquids
 Assembly Pastes
 Lubricants
 WEICON TOOLS®
 Other



Zinc Spray

Long-term cathodic corrosion protection | paintable | >1050 in the salt spray test according to DIN EN ISO 9227

WEICON Zinc Spray is approved by the German TÜV and provides a long-lasting cathodic corrosion protection to all metal surfaces. The spray forms a fast-drying, adherent protective layer of microfine zinc flakes.

Even after more than 1.050 hours in the salt spray test according to DIN 53167 and DIN 50021, metal parts coated with Zinc Spray did not show any corrosion. The zinc flakes form a resistant protective layer, even under extreme weather and environmental conditions.

Zinc Spray thus fulfils higher requirements than those defined by the DIN EN ISO 1461 standard. WEICON Zinc Spray can be used as a high-grade antirust primer, for the coating of welded joints and drilled holes, as a conductive intermediate layer for spot welding and wherever metal must be protected against corrosion.

► 400 ml
11000400



Zinc Spray bright grade

Long-term cathodic corrosion protection | bright colour shade matching hot-dip galvanization

Zinc Spray "bright grade" is approved by the German TÜV and provides a long-lasting cathodic corrosion protection to all metal surfaces. It has a bright colour shade matching hot-dip galvanization.

The spray forms a fast-drying, adherent protective layer of microfine zinc flakes. The zinc flakes form a resistant protective layer, even under extreme weather and environmental conditions.

Zinc Spray "bright grade" can be used as a high-grade antirust primer, for the coating of welded joints and drilled holes, as a conductive intermediate layer for spot welding and everywhere where metal must be protected against corrosion.

► 400 ml
11001400



Zinc-Alu-Spray

Anti-corrosion protection | colour shade matching hot-dip galvanization

Zinc-Alu Spray lastingly protects all metal surfaces against rust and corrosion. WEICON Zinc-Alu Spray forms a fast drying and adherent protective layer and is resistant to many chemicals.

Zinc-Alu Spray is dust-dry after approx. 15 minutes and can be smoothed and painted without pre-treatment after around 12 hours. WEICON Zinc-Alu Spray can be used to repair damaged hot-dip galvanized surfaces in a matching colour shade and for coating welded joints and drilled holes.

► 400 ml
11002400

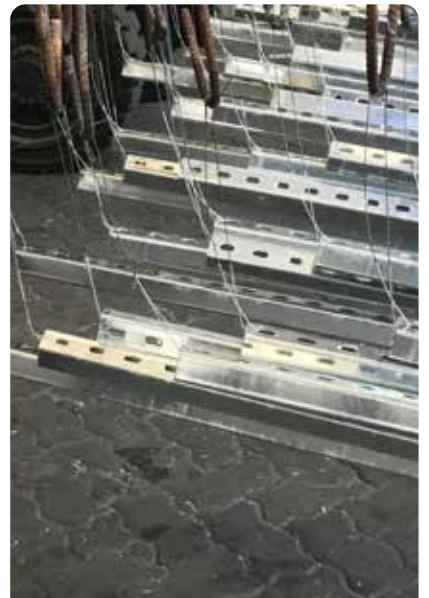

Surface and Anti-Corrosion Coatings

Galva Spray

Colour matching hot-dip galvanized surfaces | >450 h salt-spray-test DIN EN ISO 9227

WEICON Galva Spray provides a permanent protective layer for all metal surfaces. It protects metals against rust and corrosion and is fast-drying and firmly adhering.

The spray is resistant to salt water and fresh water and temperatures up to +300°C (+572°F). After more than 450 hours in the salt spray test according to DIN EN 9227, metal parts coated with WEICON Galva Spray did not show any corrosion.



The spray can be used for repairs of hot-dip galvanized parts in matching colour, as highly effective antirust primer, e.g. for painting car bodies, as coating on welded and drilled sections and as conductive intermediate layer in spot-welding.

► 400 ml
11005400





Before - after
Stainless Steel Spray

Rust Protection 2000 PLUS

Special corrosion- and weather-resistant surface coating

Rust Protection 2000 PLUS is a particularly corrosion- and weather-resistant surface coating on the basis of ferric oxide (hematite). The usage of highly-pure ferric oxide pigments in a flaky arrangement achieves permanent, weather-resistant and water-repellent surface protection.

Metal parts coated with Rust Protection 2000 PLUS did not show any corrosion after more than 2000* hours in a salt spray test. It is used wherever metal structures or systems require prolonged protection against extreme environmental and weather conditions in a visually appealing manner.

WEICON Rust Protection 2000 PLUS can be used on halls and steel structures, iron railing, lattice towers, fences, handrails, balcony grates, rolling gates, outdoor lights, and on points particularly susceptible to corrosion.

- ▶ 400 ml ▶ 400 ml
- 11013400 11012400
- silver-grey charcoal-grey



Aluminium-Spray A-100

Excellent corrosion protection | abrasion-resistant

WEICON Aluminium-Spray A-100 is abrasion-proof, resistant to many diluted acids and lyes, as well as to atmospheric influences. It contains aluminium pigments with a purity grade of <math>< >99,5\%</math>.

WEICON Aluminium Spray A-100 offers high-grade corrosion protection for all metal surfaces.

WEICON Aluminium Spray A-100 can be used in cooling and ventilation technology, combustion systems, pipelines and machine housings, fibre glass car body components, in model building, arts and crafts, toy manufacturing and in many additional applications.

- ▶ 400 ml
- 11050400



Aluminium-Spray A-400

Highest brilliancy

Aluminium-Spray A-400 has the highest brilliancy and is resistant to many diluted acids and lyes, as well as to wheater effects. It contains aluminium pigments with a purity grade of <math>< >99,5\%</math>. WEICON Aluminium Spray A-400 offers high-grade corrosion protection for all metal surfaces. Aluminium Spray A-400 can be used in cooling and ventilation technology, combustion systems, pipelines and machine housings, fibre glass car body components, in model building, arts and crafts, toy manufacturing and in many additional applications.

- ▶ 400 ml
- 11051400



Surface and Anti-Corrosion Coatings

Stainless Steel Spray

Corrosion-resistant and effective surface coating

WEICON Stainless Steel Spray is a chemical, corrosion-, and weather-resistant surface coating on the basis of acrylic resin and stainless steel pigments. It is temperature-resistant up to +300°C (+572°F).

Stainless Steel Spray can be used wherever a resistant and effective protective layer is required. The alloy is comprised of e.g. chromium, nickel and manganese.

WEICON Stainless Steel Spray can be used to repair damaged stainless steel parts on truck bodies, silos and pipelines, and outdoor applications. It can also be used for decorative purposes and for the optical refinement of glass, wood, stone, ceramics and most plastics.

▶ 400 ml

11100400



Stainless Steel Spray bright grade

Provides a treated stainless steel look e.g. V2A, V4A

WEICON Stainless Steel Spray bright grade is a chemical-, corrosion- and weather-resistant surface coating on the basis of acrylic resin and stainless steel pigments. It is temperature-resistant up to +300°C for short periods and provides a treated stainless steel look.

Stainless Steel Spray bright grade can be used wherever a resistant and effective protective layer is required. The alloy is comprised of e.g. chromium, nickel and manganese. WEICON Stainless Steel Spray

bright grade can be used to repair damaged stainless steel parts on truck bodies, silos and pipelines, and in outdoor applications. It can also be used for decorative purposes and for the optical refinement of glass, wood, stone, ceramics and most plastics.

▶ 400 ml

11104400



Chrome-Silver Spray

High-brilliance anti-corrosive surface coating on aluminium basis

Chrome-Silver Spray is a high-brilliance surface coating. The special formulation and highest purity of the metal pigments create a high-gloss finish.

WEICON Chrome-Silver Spray can be used for prototypes and samples, mirror applications (e.g. reflectors), trade show and exhibition construction, effective decorative work and for the optical refinement of various materials.

► 400 ml
11103400



Copper Spray

High-grade and effective

WEICON Copper Spray is a high-quality, weather-resistant metal spray with high adhesive strength and a high copper content for protective and decorative coatings having an effective non-ferrous metal character for indoor and outdoor use.

It is even used for the optical refinement (copper-plating) of various material surfaces or design parts.

Copper Spray can be used on window sills, gutters and downspouts, outdoor lights and mailboxes, and for arts and crafts and decorative work.

► 400 ml
11101400



Isolation Spray

Transparent insulating and finishing varnish based on acrylic resin

WEICON Isolation Spray is a transparent insulating and finishing varnish based on acrylic resin. It forms a flexible and resistant layer, which shows excellent adhesion to metal, glass, plastic or wood. It is resistant to UV radiation, acids, oils and lyes. It is moisture- and weather-resistant and has high dielectric strength.

The spray protects against moisture as well as different vapours. It serves as protective coating for circuit boards, on electrical connections, switches, switchboards, electronic components and coils, as universal sealant in electrical engineering or for the repair of insulations on electric motors, windings and frames.

► 400 ml
11551400



Technical Sprays

Surface and Anti-Corrosion Coatings

VIDEO

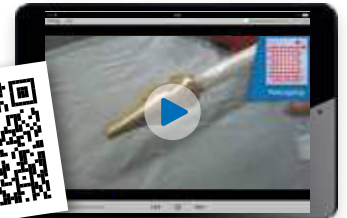

Corro-Protection

Corrosion protection of metal parts for indoor storages

WEICON Corro-Protection is a transparent protective film approved by the German TÜV. It lastingly preserves tools and precision components with a dry and waxy layer.

WEICON Corro-Protection can be used as safe corrosion protection for bare, unpainted metal parts, for the indoor storage of workpieces, as corrosion protection during overseas transport and for the conservation of tools and precision components. The protective layer can be removed easily (e.g. with WEICON Cleaner S).

► 400 ml
11550400



Brass Spray

High-grade and effective

WEICON Brass Spray is a metallic coating with a high brass content and a colour shade typical of brass. For the protection and optical refinement of various materials.

Brass Spray can be used in restoration work, for decorative purposes, in arts and crafts, hobby and do-it-yourself applications. It is suited for the sustainable repair of yellow chrome-plated parts which have been damaged by drilling, welding or milling.

► 400 ml
11102400

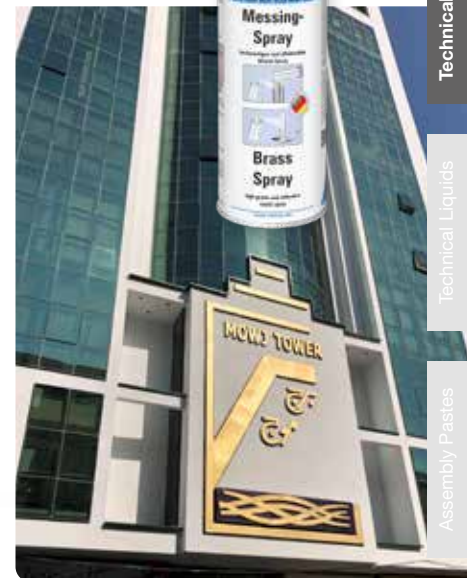

Gold-Spray

High-grade and effective metal spray

WEICON Gold Spray is a weather-proof metal spray with a high content of gold-coloured metal pigments and a high opacity. It is suitable for the visual enhancement of a wide variety of materials, such as metal, wood, plaster, concrete, masonry or plasterboard. It can be used both, indoors and outdoors.

The spray is suitable for decorating purposes, e.g. coating of figures, decorative articles or picture frames. It can be used for the touch up of yellow-chromatised parts after drilling, welding or milling.

Gold Spray can be used in many areas, such as in arts and crafts, in restoration work or in hobby and DIY.

► 400 ml
11105400





Technical Data



	Zinc Spray	Zinc Spray bright grade	Zinc-Alu Spray	Galva Spray	Rust Protection 2000 PLUS charcoal-grey	Rust Protection 2000 PLUS silver-grey
Colour:	slightly weathered hot-dip galvanization	fresh hot-dip galvanization	fresh hot-dip galvanization	fresh hot-dip galvanization	charcoal-grey / DB 703	silver-grey / DB 701
Application:	indoors and outdoors	indoors and outdoors	indoors and outdoors	indoors and outdoors	indoors and outdoors	indoors and outdoors
Binding agent:	styrenated alkyd resin	modified alkyd resin	acrylic resin	acrylic resin	alkyd resin	alkyd resin
Pigment:	flaky zinc and aluminium pigments	flaky zinc and aluminium pigments	zinc and aluminium pigments	zinc and aluminium pigments	lamellar hematite	lamellar hematite
Pigment purity:	approx. 99,9 Zn / approx. 99,9% Al	approx. 99,9 Zn / approx. 99,5% Al	approx. 99,5% Al / approx. 94,0% Zn	approx. 99,5% Al / approx. 94,0% Zn	> 90% ferric oxide	> 90% ferric oxide
Percentage of metal in dry film:	approx. 70%	approx. 70%	approx. 51%	approx. 51%	approx. 58%	approx. 58%
Content:	400 ml	400 ml	400 ml	400 ml	400 ml	400 ml
Specific Weight g/cm ³ :	1,1 - 1,3	1,0 - 1,2	0,90 - 1,0	0,90 - 1,0	1,3 - 1,4	1,3 - 1,4
Recommended primer:	not necessary	Zinc Spray	Zinc Spray	Zinc Spray	not necessary	not necessary
Processing temperature* ² :	from +5°C (+41°F) to +35°C (+95°F), optimum processing temperature from +18°C (+64°F) to +25°C (+77°F)	from +5°C (+41°F) to +35°C (+95°F), optimum processing temperature from +18°C (+64°F) to +25°C (+77°F)	from +5°C (+41°F) to +35°C (+95°F), optimum processing temperature from +18°C (+64°F) to +25°C (+77°F)	from +5°C (+41°F) to +35°C (+95°F), optimum processing temperature from +18°C (+64°F) to +25°C (+77°F)	from +5°C (+41°F) to +35°C (+95°F), optimum processing temperature from +18°C (+64°F) to +25°C (+77°F)	from +5°C (+41°F) to +35°C (+95°F), optimum processing temperature from +18°C (+64°F) to +25°C (+77°F)
Consumption at 1,5 cross coats* ³ :	approx. 150 ml/m ²	approx. 150 ml/m ²	approx. 150 ml/m ²	approx. 150 ml/m ²	approx. 160 ml/m ²	approx. 160 ml/m ²
Layer thickness at 1,5 cross coats* ³ :	approx. 30 - 50 µm	approx. 20 - 40 µm	approx. 20 - 40 µm	approx. 20 - 40 µm	approx. 60 - 80 µm	approx. 160 ml/m ²
Drying time* ³ :	Dust dry	approx. 15 minutes	approx. 15 minutes	approx. 15 minutes	approx. 15 minutes	approx. 30 minutes
	Hardened	approx. 12 hours	approx. 12 hours	approx. 12 hours	approx. 12 hours	approx. 24 hours
	Painted over	approx. 24 hours	approx. 24 hours	approx. 12 hours	approx. 12 hours	approx. 24 hours
Abrasion-resistant:	abrasion-resistant	abrasion-resistant	abrasion-resistant	abrasion-resistant	abrasion-resistant	abrasion-resistant
Cross cutting DIN 53151 / ISO 2409:	cross cut characteristic value GT 0	cross cut characteristic value GT 0 to GT 1	cross cut characteristic value GT 0 to GT 1	cross cut characteristic value GT 0 to GT 1	cross cut characteristic value GT 0 to GT 1	cross cut characteristic value GT 0 to GT 1
Salt spraying test DIN EN ISO 9227	>1.050 hours	>550 hours	>450 hours	>450 hours	---	---
Mandrel bend test DIN EN ISO 1519:	no hair cracking	no hair cracking	no hair cracking	no hair cracking	no hair cracking	no hair cracking
Top coating:	not required	not required	not required	not required	not required	not required
Temperature resistance after complete curing:	from -50°C (-58°F) to +500°C (+932°F)	from -50°C (-58°F) to +300°C (+572°F)	from -50°C (-58°F) to +300°C (+572°F)	from -50°C (-58°F) to +300°C (+572°F)	from -50°C (-58°F) to +300°C (+572°F)	from -50°C (-58°F) to +300°C (+572°F)
Shelf life* ⁵ :	24 months	24 months	24 months	24 months	24 months	24 months

*² When processing at temperatures below +10°C (+50°F), heat spray cans to room temperature +20°C (+68°F).

*³ Temperature of spray can and the surface of +20°C (+68°F) and 50% relative humidity.

Technical Sprays

Technical Data

Aluminium-Spray A-100	Aluminium-Spray A-400	Stainless Steel Spray	Stainless Steel Spray bright grade	Chrome-Silver Spray	Gold Spray	Copper Spray	Brass Spray
aluminium-metallic, matt	aluminium, bright	stainless steel metallic, matt	stainless steel metallic, bright	aluminium, glossy	gold-coloured, matte	copper-metallic, matt	brass-metallic, matt
indoors and outdoors	indoors and outdoors	indoors and outdoors	indoors and outdoors	indoors	indoors and outdoors	indoors and outdoors	indoors and outdoors
acrylic resin	hydrocarbon resin	acrylic resin	alkyd resin	natural resin	acrylic resin	acrylic resin	acrylic resin
aluminium pigments	flaky aluminium pigments	stainless steel pigments	stainless steel and aluminium pigments	flaky aluminium pigments	gold-coloured pigments	copper pigments	brass pigments
approx. 99,5% Al	approx. 99,5% Al	stainless steel alloy approx. 98,5%	VA-alloy approx. 98,5% Al	approx. 99,5% Al	approx. 99,9% Ms	approx. 99,9% Cu	approx. 99,9% Ms
approx. 43%	approx. 23%	approx. 45%	approx. 35,0%	approx. 15%	approx. 52%	approx. 50%	approx. 52%
400 ml	400 ml	400 ml	400 ml	400 ml	400 ml	400 ml	400 ml
0,9 - 1,0	0,8 - 0,9	0,9 - 1,0	0,9 - 1,0	0,8 - 0,9	0,9 - 1,0	0,9 - 1,0	0,9 - 1,0
Zinc Spray	Zinc Spray	Zinc Spray	Zinc Spray	Zinc Spray	Zinc Spray	Zinc Spray	Zinc Spray
from +5°C (+41°F) to +35°C (+95°F), optimum processing temperature from +18°C (+64°F) to +25°C (+77°F)	from +5°C (+41°F) to +35°C (+95°F), optimum processing temperature from +18°C (+64°F) to +25°C (+77°F)	from +5°C (+41°F) to +35°C (+95°F), optimum processing temperature from +18°C (+64°F) to +25°C (+77°F)	from +5°C (+41°F) to +35°C (+95°F), optimum processing temperature from +18°C (+64°F) to +25°C (+77°F)	from +5°C (+41°F) to +35°C (+95°F), optimum processing temperature from +18°C (+64°F) to +25°C (+77°F)	from +5°C (+41°F) to +35°C (+95°F), optimum processing temperature from +18°C (+64°F) to +25°C (+77°F)	from +5°C (+41°F) to +35°C (+95°F), optimum processing temperature from +18°C (+64°F) to +25°C (+77°F)	from +5°C (+41°F) to +35°C (+95°F), optimum processing temperature from +18°C (+64°F) to +25°C (+77°F)
approx. 120 ml/m ²	approx. 120 ml/m ²	approx. 120 ml/m ²	approx. 120 ml/m ²	approx. 150 ml/m ²	approx. 120 ml/m ²	approx. 120 ml/m ²	approx. 120 ml/m ²
approx. 25-35 µm	approx. 10-15 µm	approx. 20-30 µm	approx. 15-25 µm	approx. 10-20 µm	approx. 20-30 µm	approx. 20-30 µm	approx. 20-30 µm
approx. 10 minutes	approx. 10 minutes	approx. 10 minutes	approx. 10 minutes	approx. 10 minutes	approx. 10 minutes	approx. 10 minutes	approx. 10 minutes
approx. 4-6 hours	approx. 4-6 hours	approx. 4-6 hours	approx. 10 hours	approx. 4-6 hours	approx. 4-6 hours	approx. 4-6 hours	approx. 4-6 hours
approx. 4-6 hours	cannot be painted	approx. 4-6 hours	approx. 8 hours	cannot be painted	approx. 4-6 hours	approx. 4-6 hours	approx. 4-6 hours
abrasion-resistant	not abrasion-resistant	abrasion-resistant	abrasion-resistant	not abrasion-resistant	abrasion-resistant	abrasion-resistant	abrasion-resistant
cross cut characteristic value GT 0 to GT 1	cross cut characteristic value GT 0 to GT 1	cross cut characteristic value GT 0 to GT 1	cross cut characteristic value GT 0 to GT 1	cross cut characteristic value GT 0 to GT 1	cross cut characteristic value GT 0 to GT 1	cross cut characteristic value GT 0 to GT 1	cross cut characteristic value GT 0 to GT 1
---	---	>200 h	>100 h	---	---	---	---
no hair cracking	no hair cracking	no hair cracking	no hair cracking	no hair cracking	no hair cracking	no hair cracking	no hair cracking
not required	cannot be painted	not required	not required	not required	not required	not required	not required
from -50°C (-58°F) to +800°C ⁶⁵ (+1.472°F)	from -50°C (-58°F) to +800°C (+1.472°F)	from -50°C (-58°F) to +300°C (+572°F)	from -50°C (-58°F) to +300°C (+572°F)	from -50°C (-58°F) to +400°C (+752°F)	from -50°C (-58°F) to +300°C (+572°F)	from -50°C (-58°F) to +300°C (+572°F)	from -50°C (-58°F) to +300°C (+572°F)
24 months	24 months	24 months	24 months	24 months	24 months	24 months	24 months

⁶⁵ At a constant room temperature of +20°C (+68°F) and dry storage. The same applies for closed original barrels that are not subjected to direct or indirect sunlight.

⁶⁶ Above +350°C (+662°F) not abrasion-resistant.



Cleaner Spray S

Degreases and cleans all metals, glass, ceramics and most plastics

WEICON Cleaner Spray S cleans, degreases and evaporates without leaving residues. Its special valve also makes it possible to work overhead.

Cleaner Spray S can be used on all metals, glass, and ceramics, and on most plastics, and thermoplastics such as PVC, PMMA (acrylic glass), polystyrene etc.

WEICON Cleaner Spray S can be used for cleaning and degreasing before priming and painting, for cleaning machine parts or before other WEICON products are applied on surfaces where a greasy underground would impair their effect.

► 500 ml
11202500



Fast Cleaner

Cleaning and degreasing agent for sensitive areas

The Fast Cleaner has an NSF registration for the foodstuffs sector and can therefore be used as a cleaner and degreasing agent for the removal of contamination generated within the scope of maintenance work and for the removal of non-cured adhesive residues in the foodstuffs and beverages industry and in the pharmaceutical and cosmetic industries.



Fast Cleaner is used to clean and degrease surfaces which are bonded or sealed using WEICON Adhesives and Sealants, or which should be coated using WEICON metal sprays.

Fast Cleaner is pH-neutral and material-compatible, and can be used on many different materials such as metals, glass, ceramics and most rubbers and plastics.

► 500 ml
11212500



Universal Spatula

Special spatula for the gentle removal of various contamination and residues. Suitable for use in the food industry. EU Regulation 10/2011/EC plastics with food contact.

10953008
Length 25 cm, colour white



Technical Sprays Cleaners and Degreasers

Industrial Cleaner



Powerful special cleaner with high yield

WEICON Industrial Cleaner is suitable for universal use. It cleans, degreases and evaporates without leaving any residues. The cleaner removes grease, oil, soot and other soilings and residues. It cleans many surfaces fast and easily, such as metals, glass and many plastics. Industrial Cleaner can be used in many different areas.

It is even suitable for sensitive surfaces, such as plastics, rubber materials or powder-coated metal pieces. The cleaner operates with a highly compressed propellant. Therefore, it has a very high active ingredient content of 95 %. This means that the cleaner is very economical, so one container covers a significantly higher number of applications.

► 500 ml
11215500



Surface Cleaner



Pre-treatment of bonding surfaces

WEICON Surface Cleaner is used for the cleaning and degreasing of surfaces to be joined or sealed with WEICON Adhesives and Sealants.

WEICON Surface Cleaner can be applied on materials like metal, glass, ceramics and most plastics. Surface Cleaner can be used, for example, to clean and degrease machine components in the course of maintenance work.

► 150 ml ► 400 ml
11207150 11207400



Brake Cleaner



Multi-purpose cleaner, especially for the automotive sector

WEICON Brake Cleaner is a universal cleaner for the automotive industry, which cleans, degreases and evaporates without leaving residues.

Brake Cleaner quickly and effortlessly degreases and cleans metals, glass and many plastics. It removes oily and greasy impurities and residues. WEICON Brake Cleaner can be used on brakes (drum and disc brakes, brake pads, brake blocks, cylinders, springs and bushings), clutches (clutch linings and components) and on engine parts (carburetors, fuel and oil pumps, gears etc.).

► 500 ml
11203500



Plastic-Cleaner

Degreases and cleans sensitive surfaces

WEICON Plastic-Cleaner cleans, degreases and evaporates without leaving residues. WEICON Plastic-Cleaner can be used to clean and degrease sensitive surfaces such as plastics*, rubber materials or powder-coated metal parts.

Plastic-Cleaner can be used, for example, on window frames, roller blinds, plastic profiles, seals or lacquered flanges in many industrial applications.

► 500 ml
11204500

*Check material compatibility before use.



Cleaning of plastic applications
Plastic-Cleaner

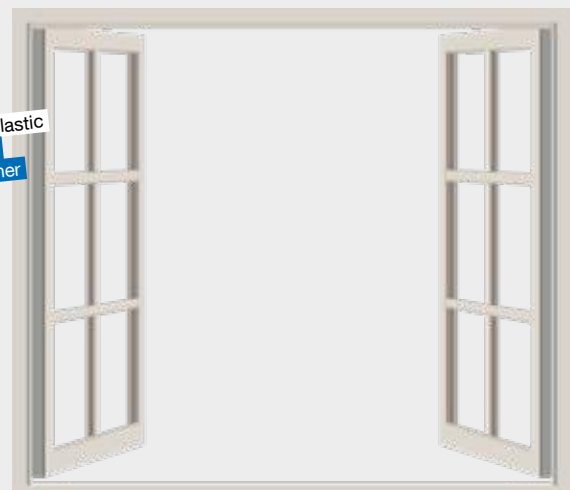



VIDEO



Burner Cleaner



Especially formulated to remove grease, oil, soot and other dirt accumulations from burner parts

WEICON Burner Cleaner is a special cleaner for the removal of grease, oil, rust and other impurities from burner parts.

WEICON Burner Cleaner evaporates without leaving residues. WEICON Burner Cleaner can be used on blast connections, baffles plates, fan wheels and in housing interiors, ignition electrodes, etc.

► 500 ml
11205500

Mould Cleaner



Cleaner on the basis of highly active organic solvents

WEICON Mould Cleaner is a special cleaner based on highly active organic solvents. It effectively removes waxes, silicones, oils, non-cured PUR residues and other impurities from plastic, steel or aluminium moulds.

► 500 ml
11203550

Parts and Assembly Cleaner



Specially developed cleaner with a high flash point (> +60°C of the agent)

WEICON Parts and Assembly Cleaner is a specially developed cleaner with a high flashpoint (>+60°C of the active ingredient) and a long working time for the removal of coarse, oily, resinified and greasy contamination. Due to its high flashpoint, Parts and Assembly Cleaner conforms to the former VbF classification AIII (VbF = Regulation concerning flammable liquids) and complies with the recommendations of the professional associations for safety at work.

WEICON Parts and Assembly Cleaner is free of acetone, butanol, ethyl acetate, etc. Parts and Assembly Cleaner quickly and thoroughly cleans all kinds of assembly parts, aggregates, construction parts and tools. It removes oils, greases, dirt, etc., from all metal parts and cleans engine brakes, clutches, engine parts, etc. in the automotive sector. The product can be used in many industrial applications.

► 500 ml
11201500



Technical Sprays

Cleaners and Degreasers

Multi-Foam

Powerful universal cleaner

WEICON Multi-Foam is a powerful universal cleaner for residue-free cleaning. It is safe for the environment, biodegradable, free of phosphates and formaldehyde and contains no corrosive or caustic substances.

Multi-Foam can be used to clean the most diverse surfaces such as metal, plastic, glass, ceramic or lacquered and coated surfaces.

WEICON Multi-Foam can be used universally in industry, skilled trades and DIY applications.

► 400 ml
11200400



proven effect according to
DIN EN 1276 and 1650

Citrus Cleaner

Cleaner and degreaser on the basis of citrus essences

WEICON Citrus Cleaner is an all-purpose cleaning agent based on alcohol and citrus peel extracts. Due to its high isopropyl alcohol content of over 75%, WEICON Citrus Cleaner makes use of its disinfectant effect, and thus supports the overall cleaning and disinfection of surfaces. It can be used for all purposes and is equally suited for use in industrial applications, skilled trades, window construction, in public institutions and public transport, in construction companies, and in housekeeping.

It cleans a wide range of materials, such as metals and plastics, glass, and ceramic as well as painted and coated surfaces*. WEICON Citrus Cleaner is also highly effective and efficient in basic hygiene and supporting additional hygiene measures, in cleaning frequently used hand tools, and in removing stains due to pencils, pens, and markers.

► 400 ml
11217400

*For safety reasons, the material compatibility should first be checked on a non-visible area.



Foam Cleaner

For the food industry

WEICON Foam Cleaner is universally applicable and can be used for the cleaning and degreasing of water-resistant surfaces and for the removal of soilings on plastic, glass and textile surfaces.

Due to its NSF A1 registration, the Foam Cleaner is suitable for use in sensitive areas, such as the food and beverage industry as well as in the pharmaceutical and cosmetic industry.

The spray is suitable for the cleaning of conveyor belts with contact to food, for example in production lines or retail shops. It removes soilings on machine housings and cleans scales, flat screens, touch screens, navigation systems and many more. Foam Cleaner eliminates many different impurities, such as oils and greases, fingerprints, soot, nicotine, dust as well as residues of insects. It can be used wherever acidic or alkaline detergents are not allowed. Due to its special formula and the resulting NSF registration, the Foam Cleaner can contribute towards improvements in occupational safety and health protection.

► 400 ml
11209400





Electro Contact Cleaner

Cleans and degreases electronic or mechanical components

WEICON Electro Contact Cleaner is a special cleaner for the fast and effective cleaning and degreasing of all kinds of soiled or corroded contacts.

Electro Contact Cleaner was specially developed for the cleaning of electrical and mechanical components. The special formula with high-purity solvents removes oxide/sulphide layers, combustion residues and resinous or sooty soiling.

WEICON Electro Contact Cleaner reduces voltage loss and increases electric conductivity. Contamination that can cause tracking current is removed. It can be used on electro-technical or mechanical components such as electrical machines, measuring instruments, tools, balances, switches and sensors or electrical connections, contacts, relays and switchboards.

▶ 400 ml
 11210400

Sealant and Adhesive Remover

Removes residues of hardened sealants and adhesives

WEICON Sealant and Adhesive Remover quickly and easily removes residues of hardened sealants and adhesives as well as lacquers and paints, even from vertical surfaces.

WEICON Sealant and Adhesive Remover can be used on metal, wood, glass, ceramics, polyethylene and polypropylene. It should not be used on sensitive plastics such as PVC, synthetics, linoleum, etc.

Sealant and Adhesive Remover loosens all kinds of sealant residues on cylinder heads, oil sumps, water pumps, exhaust manifolds, valve covers and gearbox flanges. It reliably removes oil carbon residues, paints and lacquers, and eliminates oils, resins, greases and tar. It can also be used as a paint stripper for wood restoration and removes all kinds of adhesives, even cured cyanoacrylate and anaerobic adhesives.

▶ 400 ml
 11202400



Compressed-Air Spray

Universal use | fast and reliable

WEICON Compressed-Air Spray can be used universally, wherever dust cannot be easily removed by conventional methods and on parts which are difficult to reach.

It allows dust to be removed from inaccessible corners and sensitive surfaces in a dry and contact-free manner. Compressed-Air Spray can be used on hifi and video devices (e.g. modules, circuit boards, magnetic heads, disk drives, etc.), in optics (e.g. cameras and lenses), automotive fuse boxes, windshield washer systems, clock mechanisms (quartz clocks), medical technology, model building, measurement technology, and on electronic components and circuit boards.

▶ 400 ml
 11620400



VIDEO



Technical Sprays

Cleaners and Degreasers

Visor Cleaner

Cleaner on the basis of highly active organic solvents

WEICON Visor Cleaner is a special cleaner for the cleaning and care of sensitive plastic and glass surfaces. It is antistatic and anti-reflective, reduces dazzling, and improves the view.

WEICON Visor Cleaner gently removes contamination caused by insects, dirt, dust, grease and nicotine without leaving streaks.

Visor Cleaner can be used on all kinds of visors, on welding face shields, safety goggles, vision protection, safety glass, plastic housings on CNC machines, printers, scanners, etc., and on all other plastic and glass surfaces.

► 200 ml
11211200



Screen Cleaner

Cleans carefully without leaving residues

WEICON Screen Cleaner is a special cleaner for the cleaning and care of sensitive plastic and glass surfaces. It is antistatic and anti-reflective.

Its antistatic effect provides a dirt- and dust-repellent surface. WEICON Screen Cleaner gently removes contamination caused by insects, dirt, dust, grease and nicotine without leaving streaks.

WEICON Screen Cleaner can be used on all flat and plasma screens (computers, mobiles, laptop computers, televisions, scanners, copy machines, etc.) and plastic housings (on computers, scanners, copy machines or televisions).

► 200 ml
11208200



Stainless Steel Care Spray



Antistatic cleaning

Stainless Steel Care Spray was specially formulated for the cleaning, protection and care of matt and polished stainless steel surfaces both indoors and outdoors and has an antistatic effect.

WEICON Stainless Steel Care Spray removes and prevents fingerprints, removes lubricating films e.g. from fume hoods, cleans even large surfaces without leaving streaks, and provides a long-lasting protective film which repels water and prevents new dirt from clinging. The product can be used in many applications.

► 400 ml
11590400



Cockpit-Spray

Care product for the automotive interior

WEICON Cockpit-Spray is a water-repellent care product for all plastic and rubber parts in motor vehicle interiors. The permanent invisible protective film prevents contamination and creates an easy-care, dust-repellent silky shine.

Cockpit-Spray refreshes dull and weathered plastic. Rubber does not crack and remains supple and elastic.

WEICON Cockpit-Spray eliminates squeaky and creaky noises, and cares for dashboards, inside cladding, all plastic and rubber parts, leather, wood, and chromium, and car roofs covered with synthetic leather.

It prevents door, window and boot seals from freezing, and is used as a lubricant for seatbelts, seat guides, sunroofs, window guides, door locks and wherever greasy soiling can occur.

► 400 ml
11400400



Stainless Steel Care A7 **NEW**



NSF
Norskfood Compounds
Program Listed A7
Registration 165294



Cleaning, care and protection in sensitive areas

Stainless Steel Care Spray was specially formulated for the cleaning, protection and care of brushed, matt and polished stainless steel surfaces in sensitive areas. The special spray can be used in the food and beverage industry, in canteen kitchens as well as in the pharmaceutical and medical industry.

The spray has an NSF registration (A7) and can be used in food processing areas. It removes smudges and fingerprints, reduces oxidation and corrosion, cleans even larger surfaces streak-free, leaves a long-lasting protective layer, and makes water roll off. It has an antistatic effect and adheres even to vertical surfaces.

► 400 ml
11591400



Metal-Fluid



NSF
Norskfood Compounds
Program Listed A7/A71
Registration 158104

Universal use | clean | maintain | protect

WEICON Metal-Fluid is a care and cleaning product for indoor matt and polished surfaces and has an NSF registration.

WEICON Metal-Fluid protects, cleans and maintains both metal surfaces and ceramics, wood, glass and plastics. It does not dissolve etched and printed markings or plastic surfaces and rubber seals. Due to its special formula and the resulting NSF registration, Metal-Fluid can contribute towards improvements in occupational safety and health protection.

► 400 ml
11580400



Technical Sprays

Protection and Care



Belt Dressing Spray

Suitable for highly stressed power-transmission belts

WEICON Belt Dressing Spray is a transparent belt coating based on synthetic elastomers for the most diverse types of heavily stressed drive belts.

It increases the service life, prolongs the durability of machines and systems, prevents belt slip, transmits the full drive capacity, eliminates and prevents squeaking, penetrates deep into pores, increases the effectiveness of the tensile strength, increases friction and promotes adhesion, prevents static charging, ensures suppleness and protects against ageing.

Belt Dressing Spray is suitable for many different types of belts made from all common materials such as fabric, leather, rubber or PVC. It can be used for V-belts, link belts, drive belts, flat belts, round belts, toothed belts, transmission belts, ribbed belts or conveyor belts.

WEICON Belt Dressing Spray is particularly suited for all types of drive belts in machines, aggregates, compressors, pumps, generators, conveyors, mills, pillar drills, and cooling units. The product can be used in many industrial sectors.

► 400 ml
11511400



Hand Protective Foam

Waterproof and providing lasting protection

The skin is the largest and one of the most complicated organs in the human body, it has multifaceted adjustment and defence mechanisms and provides protection against environmental influences.

Bacteria, viruses and fungi can be found everywhere in the environment and also live on our skin. Most of these microorganisms are harmless to us. Some, however, can make us sick when entering our body. Skin damages are one of the many gateways for pathogens to the human body. Therefore, it is important to take care of and protect the skin.

One important element of effective skin protection is the special care with WEICON Hand Protective Foam, which protects your hands from harmful environmental influences for several hours. WEICON Hand Protective Foam provides temporary protection against aggressive sea and industrial environments, chemicals, solvents, alkalis, acids, salts, cleaning agents, oils, greases, cement, mortar, varnishes, adhesives, or longer contact with aqueous media. However, the foam does not replace a conventional protective glove. The Hand Protective Foam does not block skin respiration or dry out the skin, while protecting it against swelling, irritations, inflammations and adhering dirt. That way, the Hand Protective Foam supports the skin in providing a natural protective barrier.

► 200 ml
11850200

WEICON Hand Protective Foam

- absorbs quickly
- leaves an invisible, non-greasy and waterproof protective film
- non-greasy, non-slip "invisible glove"
- supports the natural barrier of the skin and is dermatologically tested
- easy and hygienic use thanks to spray can



Rust Converter

Rust Converter and base coat in one process

WEICON Rust Converter: For the effective neutralisation of rust on rusty cast iron and steel surfaces. Protects from corrosion and is suitable for internal and external use.

The Rust Converter is based on epoxy resin and forms a metallic-organic iron complex with the rust layer. This connection is stabilized with the special epoxy resin, which protects metals from external impacts. The forming black layer serves as base coat and is the foundation for the subsequent, permanent coating.

The spray is anti-corrosive, shows excellent capillary action and a high opacity. It is temperature-resistant up to +80°C (+176°F) (short-term < 15 min. to +160°C (+320°F)), has good weather and UV resistance as well as excellent solvent resistance. WEICON Rust converter is free of heavy metals and mineral acid and odourless.

Rust Converter can be applied to all rusty areas, e.g. at machines and plants, agricultural equipment as well as motor vehicles. The spray can also be used as a protective, preventive layer.

► 400 ml
11155400



Rust Shock

The "chemical wrench"

WEICON Rust Shock is free of mineral oil, grease and silicone.

Rust Shock is a "chemical wrench" and uses its chill effect and capillary properties to loosen threaded joints in seconds.

WEICON Rust Shock can be used in all industrial sectors requiring threaded joints to be loosened.

► 400 ml
11151400



Adhesives / Sealants
Technical Sprays
Technical Liquids
Assembly Pastes
Lubricants
WEICON TOOLS®
Other

Technical Sprays

Solvents and Release Agents



Rust Loosener Fluid



Penetrating oil for sensitive areas

Rust Loosener Fluid is physiologically harmless and has an NSF registration for the foodstuffs sector. This means that it can be used in the foods and beverages industry and in the pharmaceuticals and cosmetics industries.

Rust Loosener Fluid loosens rusted and oxidised screw connections, bolts, levers, joints and hinges as well as seized mechanisms on components. Due to its excellent capillary action, Rust Loosener Fluid can also penetrate the smallest cavities. It secures the function of mechanical parts and electrical contacts. The spray lastingly protects against corrosion and oxidation. It cleans and cares for metal surfaces, mechanical parts and electrical systems.

Due to its special formula and the resulting NSF registration, Rust Loosener Fluid can contribute towards the improvement of workplace safety and health protection.

► 400 ml
11154400

Rust Loosener and Contact Spray



Sixfold function

The sixfold function of Rust Loosener and Contact Spray makes it indispensable for repairs, maintenance and servicing. Thanks to its excellent capillary action, WEICON Rust Loosener and Contact Spray reaches even the smallest intermediate spaces. The 3-way spray valve makes it possible to work in any position (even overhead).

WEICON Rust Loosener and Contact Spray loosens rusted and stiff parts, screws, bolts, joints and hinges, dispels water from ignition systems, secures the function of mechanical parts and contacts, e.g. on distributor caps and spark plugs, sustainably protects against corrosion and oxidation, provides long-lasting lubrication to sliding surfaces, and cleans and maintains metal surfaces, mechanical parts and electrical systems.

► 400 ml
11150400

Contact Spray



Dispels moisture | prevents leakage current

WEICON Contact Spray is based on a special combination of active ingredients for the protection and care of electrical contacts and components.

It dispels moisture from electrical contacts, prevents leakage currents and voltage loss and keeps contacts, fuses, cable connections, etc. free of oxidation and sulphide layers.

WEICON Contact Spray can therefore be used, for example, on fuse boxes, speaker systems, gate drives, electrical outlets, cable and electrical connections, cable reels and extensions, electrical garden equipment and lighting systems.

► 400 ml
11152400



Angle grinding test

For the sanding of aluminium, abrasive flap wheels are used on all common angle grinders powered by an electric motor or compressed air.

Test components were:

- ▶ angle grinder (1.400 W)
- ▶ flap wheel Ø 125 mm, 60 grit
- ▶ approx. 10.000 RPM
- ▶ contact pressure approx. 4 kg
- ▶ aluminium block (AlSi9Cu3)

By using Alu Grinding Protection, the removal rate could be increased by up to 350 %.

Increased material removal by **350%**



Technical Sprays

Technical Liquids

Assembly Pastes

Lubricants

WEICON TOOLS[®]

Other



Label Remover

Including special spatula

WEICON Label Remover quickly and easily removes paper labels and residues of acrylate and caoutchouc-based pressure-sensitive adhesives.

Label Remover is suitable for many surfaces such as glass, metal, wood, foil and plastic. WEICON Label Remover easily and safely removes adhesive labels, price tags (e.g. incorrect labels), address and product stickers, identification labels, and label residues. It also removes adhesive residues from foil labels such as vignettes on car windshields.

- ▶ 500 ml
- 11206500



Chewing Gum Remover

Including special spatula

Chewing Gum Remover even removes old chewing gum and plasticine residues. The chewing gum and plasticine residues are frozen when sprayed on with WEICON Chewing Gum Remover and can be detached immediately and without damaging textiles or floor coatings.

WEICON Chewing Gum Remover removes chewing gum and plasticine residues from upholstered furniture, bus seats (rigid foam), school chairs and tables, textile floorings of all types and elastic and hard floor coverings such as wood and stone floors, PVC and linoleum flooring.

- ▶ 400 ml
- 11630400



Mould Release Agent

Silicone-free sliding and release agent

Mould Release Agent is a silicone-free sliding and release agent. The high-grade combination of active ingredients, consisting of pure natural products, has a high sliding effect which prevents its adhesion to plastics, moulds, metals and tools.

WEICON Mould Release Agent can be used in plastic processing and for spraying, pressing, and vacuum deforming.

- ▶ 400 ml
- 11450400



Technical Sprays

Solvents and Release Agents



Alu Grinding Protection

Effective with all abrasives | silicone-free

WEICON Alu Grinding Protection works like a cooling lubricant and separating agent during the grinding process. It lowers the temperature at the contact point and forms a silicone-free anti-adhesive layer on the abrasive material. The use of WEICON Alu Grinding Protection avoids clogging, and the pores of the grinding media remain open.

WEICON Alu Grinding Protection greatly increases the tool life of an abrasive disc and the grinding performance can be increased by up to 350%. It can be used for all abrasive materials on foundations such as fibre wheels, sheeting, endless grinding bands, abrasive sleeves, orbital sanders, and special machines.

▶ 400 ml
11451400



Anti-Spatter Spray

Silicone-free

WEICON Anti-Spatter Spray contains no silicone and is used to clean welding nozzles and to keep them clean. At the same time, it protects the work piece to be welded against the effect of weld splashes without impairing the welding seam.

Anti-Spatter Spray prevents the adhesion of welding splashes on gas nozzles and workpiece surfaces, offers gap-free protection for the welding process, and makes followup cleaning of the workpieces with a spatula, brush or chisel superfluous. Posttreatment of the workpiece such as: bronzing, galvanization, anodising or painting is possible without special cleaning. Cleaning, for example with WEICON Spray Cleaner S, may be necessary solely in the case of excessive spraying.

▶ 400 ml
11700400



VIDEO



Ceramic Anti-Spatter Spray **NEW**

High-temperature-resistant release agent | protective coating for MIG/MAG welding processes

WEICON Ceramic Anti-Spatter Spray is a high-grade release agent and lubricant, which is suitable for extremely high pressures and temperatures. The spray is a ceramic protective coating for MIG/MAG welding processes. It forms an anti-spatter dry film, which prevents the adhesion of welding spatter. That way, welding tips and gas nozzles are protected. The use of the spray minimises downtimes and interruptions in the production process to clean the welding equipment.

Ceramic Anti-Spatter spray is silicone-free. It protects welding heads on welding robots, welding tips and gas nozzles as well as sensitive equipment, cables, sensors etc. against the adhesion of welding spatters. It is also suitable for applications in plasma and laser cutting, brazing, aluminium extrusion, the foundry industry, sinter metallurgy, the glass industry and high-temperature furnace construction.

▶ 400 ml
11702400



W 44 T®-Fluid

Multifunctional oil for sensitive areas

W44T-Fluid is a physiologically harmless multifunctional oil and has an NSF registration for the foodstuffs sector. This means that it can be used in the foods and beverages industry and in the pharmaceuticals and cosmetics industries.

The resin and acid-free oil unites lubrication, water repellency, corrosion protection, cleaning and conservation in one product due to a special active ingredient formula and excellent capillary action.

W44T-Fluid loosens seized screw connections, bolts, fittings, locks and valves, and penetrates and dissolves rust. It displaces the humidity from electrical contacts, prevents leakage current and facilitates the start-up of wet motors. The oil removes squeaking and creaking noises on hinges, guides, bearings and all types of joints and couplings. It cleans contamination and metal surfaces and leaves a durable, thin film, which does not smear or stick or attract dust, and which protects and maintains all tools, machines, electrical and mechanical precision devices and keeps them functional.

Due to its special formula and the resulting NSF registration, W 44 T Fluid can contribute towards the improvement of workplace safety and health protection.

W 44 T® Multi-Spray

Multifunctional oil with multiple effects

WEICON W 44 T® is a multifunctional product which, thanks to its special formula and outstanding capillary action, combines corrosion protection, water repellency, lubrication, conservation and cleaning in a single product.

WEICON W 44 T® loosens seized threads, bolts, fittings and valves, penetrates and dissolves rust, dispels moisture from electrical contacts, prevents tracking currents and makes it easier to start wet motors. W 44 T® can also be used as cutting oil for drilling and cutting processes.

It eliminates squeaky and creaky noises on hinges, guides, bearings and all types of joints and couplings. It cleans soiled metal surfaces and leaves a long-lasting razorthin film which does not smear or stick and does not attract dust. It protects and preserves all types of tools, machines, and electrical and mechanical precision devices and keeps them functional. The use of WEICON W 44 T® has almost no limitations in workshop, automotive, shipping, electrical, agricultural, household and hobby applications.

- ▶ 50 ml ▶ 200 ml ▶ 400 ml ▶ 500 ml
- 11251050 11251200 11251400 11251550

- ▶ 400 ml
- 11253400



Adhesives / Sealants

Technical Sprays

Technical Liquids

Assembly Pastes

Lubricants

WEICON TOOLS®

Other

Lubricating and Multifunctional Oils

AT-44 Allround-Spray

With PTFE super power

WEICON AT-44 is an allround spray with PTFE and without silicone which, thanks to its special formula and very low friction coefficient, combines corrosion protection, cleaning, water repellency, lubrication and conservation in a single product. AT-44 loosens seized threads, bolts, fittings and valves, dispels moisture from electrical cables, prevents tracking currents and makes it easier to start wet motors. It eliminates squeaky and creaky noises on hinges, guides, bearings and all types of joints and couplings. It cleans soiled surfaces and leaves a razor-thin film which does not smear or stick and does not attract dust. It protects and preserves all types of tools, machines, and electrical and mechanical precision devices and keeps them functional.

WEICON AT-44 knows almost no limitations in workshop, automotive, shipping, electrical, agricultural, household and hobby applications.

- ▶ 150 ml ▶ 400 ml
- 11250150 11250400



VIDEO



- ▶ 200 ml ▶ 500 ml
- 11600200 11600500

Bio-Cut

Cutting oil for all metals

WEICON Bio-Cut is free of mineral oils and biodegradable. Thanks to its particularly high lubricating effect, it enables higher cutting speeds, a longer service life and thus higher performance of cutting tools.

WEICON Bio-Cut can be used for drilling, grinding, milling, grating, sawing, punching and reaming of all kinds of steel, cast iron, stainless steels, copper, brass, aluminium and their alloys in all areas of industry.

- ▶ 400 ml

11750400



Bio-Fluid

High-purity mineral oil

WEICON Bio-Fluid is a medically pure white oil containing no resins or acids which was specially developed for lubrication and care. It is water-clear, free of solvents, odourless and tasteless, and water-repellent. It shows excellent capillary action and has an NSF registration. Bio-Fluid reduces friction and wear, suppresses squeaky noises, protects against corrosion and removes dirt and rust.

Bio-Fluid can be used for the lubrication, protection and maintenance of precision mechanisms, as a spray oil for production and filling plants, and as a lubricant for filling and packaging systems. It can be used wherever occasional, technically unavoidable contact with food or its packaging can occur. WEICON Bio-Fluid was developed for applications in the food, beverage, pharmaceutical and cosmetic industries.

V 44 T®
Multi-Spray

-50°C (-58°F) -
+210°C (+410°F)





Silicone-Fluid

Special sliding and lubricating agent for sensitive areas

WEICON Silicone-Fluid is a special, physiologically harmless sliding agent and lubricant for sensitive areas. It has an NSF H1 registration for the foodstuffs industry, and can therefore be used in the foods and beverages industry and in the pharmaceuticals and cosmetics industries.

Silicone-Fluid is used as a separating, protection and care agent and can be used on very different surfaces such as plastic, metal, stainless steel and rubber.

Silicone-Fluid has a durable and good surface quality and is temperature-resistant up to +250°C (+482°F). Due to its special formula and the resulting NSF H1 registration, WEICON Silicone-Fluid can contribute towards the improvement of workplace safety and health protection.

► 400 ml
11351400



Adhesives / Sealants

Technical Sprays

Technical Liquids

Assembly Pastes

Lubricants

WEICON TOOLS[®]

Other

Silicone Spray



Sliding and release agent

WEICON Silicone Spray is a sliding and release agent as well as a preservative and care product for plastic, rubber and metal.

WEICON Silicone Spray provides a durable separating film and good surface properties. Silicone Spray prevents the formation of adhesive residues on presses and guides, prevents products from sticking to conveyor belts, chutes and sliding ways, protects electrical contacts from moisture, preserves rubber, plastic and metal parts, protects rubber parts from becoming brittle, freezing and sticking and allows sunroof rails, seat tracks and seatbelt rollers to run smoothly.

► 400 ml
11350400

Pneuma-Lube



Lubricant for pneumatic equipment | high content of PTFE

As a lubricating and corrosion protection agent, this product is the universal problem-solver for all moving parts in pneumatic equipment and accessories. Its special product formula with a high content of PTFE makes it a multi-purpose product for: lubrication, corrosion protection, cleaning, water repellency and conservation.

Pneuma-Lube not only serves in installation or maintenance of pneumatic equipment and accessories but can also be used on pneumatic tools in operation. The excellent weathering resistance allows the use also in other sectors, e.g. in the on- and offshore industry.

► 400 ml
11260400

Fitting Spray



Free of silicones and resins

WEICON Fitting Spray is a maintenance and care product with good adhering properties, which contains no silicone, resin, acid or solvents. Thanks to its special creeping and water-repellent properties, WEICON Fitting Spray reduces friction and wear and suppresses squeaky noises.

WEICON Fitting Spray is weather-resistant, protects against corrosion, and loosens dirt. It can be used for the lubrication, servicing and maintenance of fittings on windows, doors, gates, garages, tilt-and-turn hinges and shear fittings in many industrial applications.

► 200 ml
11560200



Lubricating and Multifunctional Oils

PTFE-Spray

Grease-free | excellent sliding properties (non-stick)

WEICON PTFE-Spray is a grease-free PTFE based dry lubricant with excellent sliding properties. WEICON PTFE-Spray adheres to all metal, plastic and wood surfaces. Its high PTFE content greatly reduces the friction coefficient. The coating repels dirt, dust and water and is resistant to oils, greases and many chemicals.

PTFE-Spray can be used on runners and guides, conveyor belts, transport rollers, slides, windows, cutting tools and packing machines. It can also be used as a permanent lubricant for shafts in plastic bearings, as a water-repellent coating for paper seals, cork seals and seal packaging, as a substitute for release agents containing silicone, and wherever oil or grease lubrication is not permitted or desired. The product can be used in many industrial applications.

▶ 400 ml
11300400



VIDEO



PTFE-Fluid

Dry lubricant for sensitive areas

PTFE-Fluid is a special dry lubricant with strong anti-adhesive effect, and has an NSF registration for the foodstuffs sector. This means that it can be used in the foods and beverages industry and in the pharmaceuticals and cosmetics industries.

Due to the high proportion of PTFE, the spray provides an anti-adhesive effect, through which the friction value on the coated surfaces is substantially reduced. PTFE-Fluid is grease-free and adheres to all metal, plastic and wooden surfaces. The coating repels dirt, dust and water and is resistant against oils, greases and many chemicals. Due to its special formula and the resulting NSF registration, WEICON PTFE-Fluid can contribute towards the improvement of workplace safety and health protection.

The spray can be used as permanent lubrication in many sensitive industrial areas such as on sliding and running rails and guides, on conveyor belts, transport rollers and slides, on tilt mechanisms, locks and hinges, on cutting tools and packaging machines, for shafts in plastic bearings and as a coating for solid seals and assembly aids for seal packs.

▶ 400 ml
11301400



Anti-Friction Spray MoS₂

Dry lubricant

Anti-Friction Spray MoS₂ is a grease-free dry lubricant with pressure and temperature resistance from -200°C (-328°F) to +450°C (842°F). The layer repels dust, dirt and water, resists oils, greases and many chemicals and adheres to metals, plastics and wood surfaces.

The high portion of MoS₂ provides clean sliding lubrication, reduces friction, has excellent emergency running properties and reduces running noises.

WEICON Anti-Friction Spray MoS₂ shortens and improves the slide-in conditions for sliding bearings, gears and other slide pairings, particularly at high pressure load and low sliding speed.

WEICON Anti-Friction Spray MoS₂ can be used on sliding and running rails and guides, conveyor belts, transport rollers and slides, as a coating for cutting, on loading technology products, as a substitute for release agents containing silicone, and wherever oil or grease lubrication is not permitted or desired.

▶ 400 ml
11539400





Top-Lube

Excellent capillary action

Top-Lube is a synthetic, transparent adhesive lubricant for the permanent lubrication of all types of highly stressed mechanical parts.

WEICON Top-Lube has a high adhesive and spinning strength and shows outstanding capillary action. It is pressure-resistant, water-repellent and can also be used during on-going operation in compliance with the respective safety regulations. It does not attack the following plastics and elastomers: PTFE, PE, PA, fluorinated -, butadiene and silicone rubber, and polychloroprene. The following materials have a limited resistance: PE-LD, POM, PP, NBR.

WEICON Top-Lube can be used on power-transmitting bolts, gearwheels, worm gears, fast-running machine parts, joints, couplings, rollers, ball bearings and spring assemblies in many industrial applications.

► 400 ml
11510400

Chain and Rope Lube Spray

Adherent and high-pressure-resistant

WEICON Chain and Rope Lube Spray is a synthetic, transparent adhesive lubricant for the permanent internal and external lubrication of all types of highly stressed chains and wire ropes.

Chain and Rope Lube Spray is particularly strongly adherent, shows excellent capillary action, suppresses noise, repels water and prevents elongation, friction and wear.

WEICON Chain and Rope Lube Spray can be used on all types of chains and wire ropes, gearwheels, worm gears, fast-running machine parts, joints, couplings, rollers, ball bearings and spring assemblies in many industrial applications.

► 400 ml
11500400

Universal Spray-on Grease with MoS₂

High-pressure-resistant

WEICON Universal Spray-on Grease with MoS₂ is a high-pressure-resistant and strong long-term lubricant which reduces friction and wear for prolonged periods.

WEICON Universal Spray-on Grease with MoS₂ is suitable for rolling and slide bearings, joints, levers, sliding guides, spindles, camshafts, spline shafts, springs, exposed gears and worm gears and at all sliding speeds permitted for grease lubrication. WEICON Universal Spray-on Grease with MoS₂ can be used in the industrial and building sectors, in rolling mills, machine tools, agricultural and construction machines and in road and rail vehicles.

► 400 ml
11530400

Top-Lube-Fluid

Adhesive lubricant for sensitive areas

Top-Lube Fluid is a special adhesive lubricant and has an NSF registration for the foodstuffs sector, meaning that it can be used in the food and beverage industry and in the pharmaceuticals and cosmetics industries.

Top-Lube Fluid is particularly adherent and pressure-resistant, shows excellent capillary action, and is also noise-dampening and water-repellent. The spray prevents elongation, friction and wear.

Due to its special formula and the resulting NSF registration, WEICON Top-Lube Fluid can contribute towards the improvement of workplace safety and health protection. The spray can be used on toothed wheels and worm gears, on joints and couplings, on rollers and bearings, on chains and wire cables or on spring assemblies as well as in numerous industrial fields.

► 400 ml
11512400



Nonfood Compounds
Program Listed H2
Registration 152617
NO FOOD CONTACT

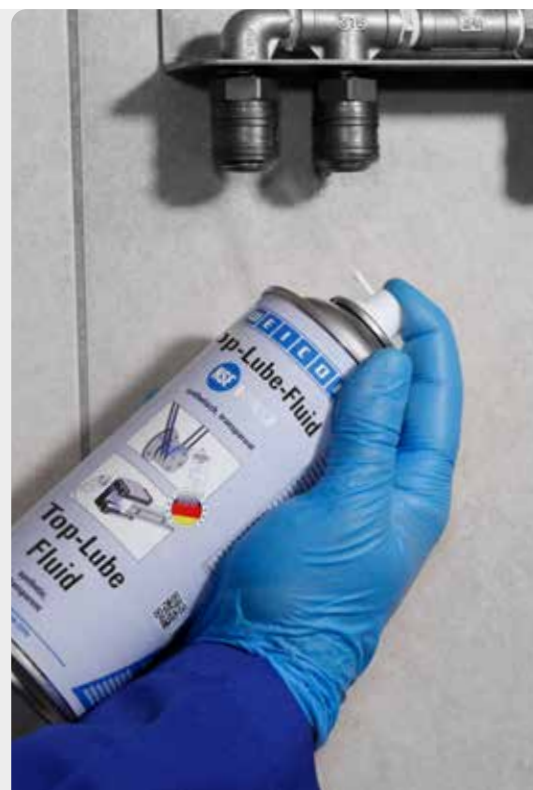

Grease Sprays

Adhering Grease extra strong



Also for underwater applications

WEICON Adhering Grease extra strong is a special lubricant and corrosion protectant even for underwater applications. It provides effective protection against aggressive fluids in maritime applications and in wet plants.

Adhering Grease extra strong is suitable for rolling and sliding bearings even in mixed friction operation, for joints, levers, sliding guides, spindles, spline shafts, exposed gears, worm gears, chains and wire cables and at all sliding speeds permitted for grease lubrication. The product can be used in many applications.

▶ 400 ml
11540400

Spray-on Grease white



All-purpose sprayable grease

Spray-on Grease white is a multi-purpose sprayable grease with an outstanding adhering strength and excellent aging and pressure resistance. The addition of special wear-reducing and corrosion-inhibiting additives results in temperature stability from -20°C to +150°C (-4 to +302°F) in combination with a long service life. As usual with transparent products, a visual inspection is possible at all times.

WEICON Spray-on Grease white can be used for the long-term lubrication of rods, gearwheels, rollers, ball bearings, hinges, guides and all types of joints and couplings in many industrial applications.

▶ 400 ml
11520400

Spray-on Grease H1



High-temperature grease

WEICON Spray-on Grease H1 is an odourless and tasteless grease that has been specially formulated to meet the requirements of the food, cosmetic and pharmaceutical industry. It is high-temperature-resistant and has an NSF registration.

Spray-on Grease H1 is particularly suited for servicing and maintenance in breweries and in the beverage industry, in industrial slaughterhouses, canneries, coffee-roasting establishments, industrial kitchens, swimming pools, hotels, hospitals and wherever direct contact with food cannot be excluded.

Due to its special formula and the resulting NSF registration, the Spray-on Greas H1 can contribute towards improvements in occupational safety and health protection.

▶ 400 ml
11541400



VIDEO





Anti-Seize Assembly Spray

Reliable protection against corrosion, seizing and cold welding

WEICON Anti-Seize Assembly Spray is high-temperature-resistant and has excellent separating characteristics.

WEICON Anti-Seize is used as a protecting, separating and lubricating agent for highly stressed parts. Ideally compatible solid contents and selected additives enable a wide range of usage.

WEICON Anti-Seize protects against corrosion, seizure and wear, stick-slip phenomena, oxidation, fretting corrosion and electrolytic reactions ("cold welding"). The product can be used in many industrial applications.

- ▶ 100 ml ▶ 400 ml
- 27000100 27000400



Anti-Seize Assembly Spray High-Tech



Metal-free

WEICON Anti Seize "High-Tech" is high-temperature-resistant, has excellent separating characteristics, is metal-free, neutral to materials and has an NSF registration.

Anti-Seize High-Tech is a dry lubricant paste for metal screw connections and particularly suitable when metal-containing pastes can cause electrolytic reactions, when nickel-containing products should or may not be used due to health reasons and when dark metal-containing products should or may not be used for visual reasons.

- ▶ 400 ml
- 27050400

Copper Paste Assembly Spray

Protecting, separating and lubricating agent for highly stressed parts in high-temperature applications

WEICON Copper Paste Assembly Spray is a protecting, separating and lubricating agent which is high-temperature-resistant, corrosion-resistant and strong. It contains no sulphur, lead or nickel.

Copper Paste Assembly Spray is used as an assembly lubricant for all kinds of threaded joints and sliding surfaces. It forms an effective lubricating and separating film which protects the functional surfaces on plug-in tools, wear bushings, screws, and all kinds of threaded, plug-in and bayonet joints against corrosion and seizing.

It can be used to reduce vibration on brake blocks and guides, brake cams and pins, car and truck battery terminals and other electrical connections, wheel bolts and nuts, and on wear bushings at electrical, compressed air and hydraulic hammers.

- ▶ 400 ml
- 27200400

Sales-Display

- ▶ 500 ml Spray 11951079
- ▶ 400 ml Spray 11951082

Inlay 400 ml

- ▶ Multi-Foam 11951089
- ▶ Citrus Cleaner 11951088
- ▶ AT-44 11951087
- ▶ W 44 T® 11951086
- ▶ Surface Cleaner 11951085
- ▶ Silicone Spray 11951084
- ▶ Zinc Spray bright grade 11951083
- ▶ Rust Converter 11951107
- ▶ Allround Sealing Spray 11951108

Inlay 500 ml

- ▶ W 44 T® 11951096
- ▶ Industrial Cleaner 11951097
- ▶ Cleaner Spray 11951094



Adhesives / Sealants
 Technical Sprays
 Technical Liquids
 Assembly Pastes
 Lubricants
 WEICON TOOLS®
 Other

Assembly Sprays and Adhesive Sprays

Adhesive Spray extra strong

Special product for strong and reliable adhesions

Adhesive Spray extra strong is a special formula for strong and permanent bonds on rough and uneven surfaces. A special valve allows the adhesive quantities to be adjusted with infinite variability.

WEICON Adhesive Spray extra strong can be used for the bonding of felt, PVC foil, imitation leather, carpets, plastics, cardboard, foam and cellular rubber, insulating materials, soft foam, vinyl, leather, rubber, metal and wood. It is also suitable for large-area adhesive bonding.

► 500 ml
11801500



Adhesive Spray

Universal use

WEICON Adhesive Spray can be used universally and bonds light materials to themselves and among each other.

Adhesive Spray is suitable for the bonding of numerous materials such as paper, cardboard, pasteboard, wood, thin veneers, cork, leather, textiles, felt, soft foam, rubber, foam rubber, and plastic film (except for PVC and polyethylene). It is especially suited for the bonding of hard foam (e.g. polystyrene).

► 500 ml
11800500



Adhesive Spray for detachable joints

Transparent

WEICON Adhesive Spray for detachable joints is especially suited for detachable and adjustable joints. It is colourless, does not soak through or cause discolouration, and does not leave a wavy surface, even when used on thin materials.

Adhesive Spray for detachable joints can be used to bond paper, cardboard and foils. The joint is detachable when the spray is applied to one side; applying the spray to both sides makes the joint permanent.

WEICON Adhesive Spray for detachable joints can be used, for example, to fuse templates, billboards, posters, photos, decorations in trade show construction, layouts and technical drawings.

► 500 ml
11802500





Leak Detection Spray

DVGW-approval | foam-forming leak detector according to DIN EN 14291 | non-flammable | anti-corrosive

The spray is used for the fast, convenient and reliable location of leaks (cracks or porous spots) in pressurized pipes.

WEICON Leak Detection Spray does not form any hazardous compounds with carbon dioxide (CO₂), propane, butane, acetylene, oxygen, city or natural gases. Leak Detection Spray can be used wherever compressed air, natural or liquid gas is processed, and wherever leaky points can occur on fittings, threaded joints, and connections. It greatly contributes to the safety of pneumatic brakes and gas lines.

- ▶ 400 ml
- 11651400



Leak Detection Spray frost-proof



DVGW-approval | foam-forming leak detector according to DIN EN 14291 | non-flammable | anti-corrosive | frost-proof up to -15°C (+5°F)

The safe, easy and quick way to find leaks or porous spots on gas pipes. Leak Detection Spray frost-proof does not form any harmful compounds with these gases: carbon dioxide (CO₂), propane, butane, acetylene, oxygen, coal and natural gas, nitrogen, dinitrogen monoxide (N₂O) and CFC and is non-flammable.

Leak Detection Spray frost-proof is suitable wherever compressed air or gaseous substances are being used. For example, it can be used on pipes, hoses, fittings, screw connections, valves and adapters.

- ▶ 400 ml
- 11654400

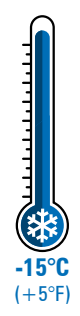

Leak Detection Spray viscous



DVGW-approval | foam-forming leak detector according to DIN EN 14291 | non-flammable | anti-corrosive | non-drip

WEICON Leak Detection Spray viscous is the quick, easy and reliable way to find leaks in gas and compressed air pipes and fittings. The spray does not form harmful compounds with the following gases: carbon dioxide (CO₂), propane, butane, acetylene, oxygen, coal and natural gas, nitrogen, dinitrogen monoxide (N₂O) and CFC and it is non-flammable.

The spray is applicable wherever compressed air or gaseous substances are being used. Typical application areas for the spray are pipes, hoses, fittings, screw connections, valves and adapters.

- ▶ 400 ml
- 11653400

Leak Detection Sprays and Crack Testing Agent

Crack Testing Agent

1 & 3

Cleaner

Material-neutral special cleaner for the dye penetrant test. Suitable for metals, many plastics, ceramic materials, glass etc. The suitability for plastic has to be tested in advance.

► 500 ml
11692500

2

Penetrant

Red diffusion agent with excellent capillary action for the non-destructive material testing - washes off with solvent. Suitable for metals, many plastics, ceramic materials, glass etc. The suitability for plastic has to be tested in advance.

► 500 ml
11690500

4

Developer

Colourfast special developer on solvent basis for dye penetrant tests. Suitable for metals, many plastics, ceramic materials, glass etc. The suitability for plastic has to be tested in advance.

► 500 ml
11691500

ALSO AVAILABLE AS
SET

11896900

The WEICON Crack Testing Agent Set comprises:
1 x 500 ml Cleaner (11692500)
1 x 500 ml Penetrant (11690500)
1 x 500 ml Developer (11691500)



Standards and regulations
Sample-tested according to DIN EN ISO 3452-2. Low sulphur and halogen content, according to DIN EN ISO 3452-2 and ASME-Code, Section V, Article 6, T641,07-2015.



1

Cleaning the surface with the Cleaner



2

Apply Penetrant and allow to react



3

Clean again to remove excess Penetrant



4

Apply Developer and perform final visual assessment



Adhesives / Sealants

Technical Sprays

Technical Liquids

Assembly Pastes

Lubricants

WEICON TOOLS®

Other

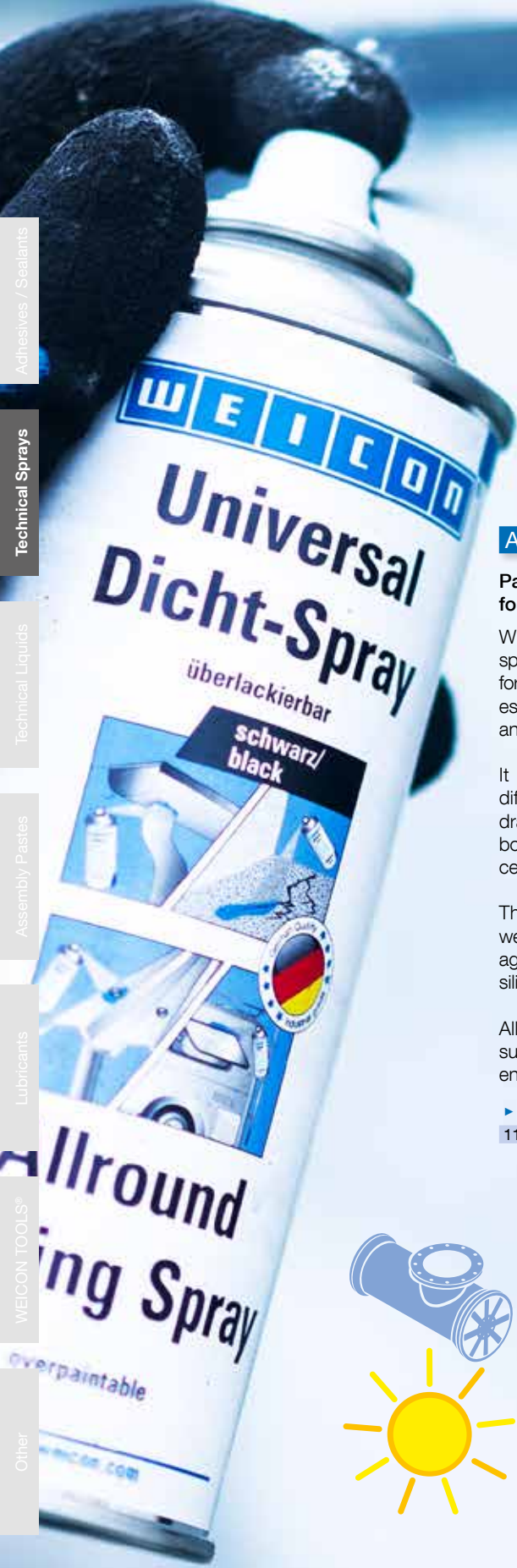

Allround Sealing Spray



Paintable | for indoor and outdoor use

WEICON Allround Sealing Spray is a sprayable plastic with high adhesive strength for the sealing of leaks. It has been developed especially for the sealing of the finest cracks and seams indoors and outdoors.

It can be used for the sealing of many different things, like gutters, sewage and drainage pipes, caravans, mobile homes, boats, roofs, windows, pool walls, pond foils, cell shafts and ventilation shafts.

The spray is paintable, waterproof and weather- and UV-resistant. It protects metals against corrosion and is free of bitumen and silicone.

Allround Sealing Spray adheres to many surfaces, like stone, metal, plastic, wood, enamel, and many more.

- ▶ 400 ml 11554400 black
- ▶ 400 ml 11555400 grey
- ▶ 400 ml 11553400 white

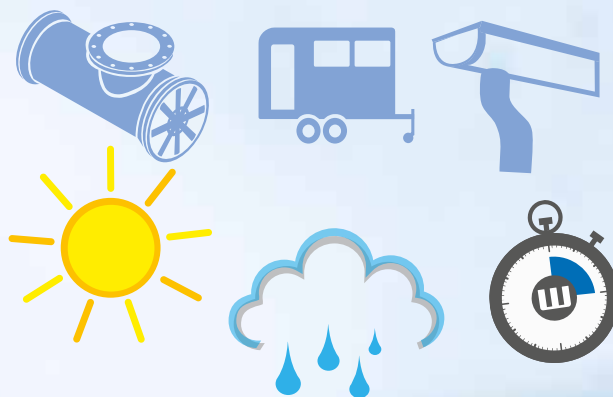

Special Sprays



Smoke Detector Test Spray

Silicone-free | evaporates without leaving residues

WEICON Smoke Detector Test Spray is ideal for a secure checking of the correct functioning of optical or photoelectrical smoke detectors and smoke switches.

The use of Smoke Detector Test Spray does not contaminate the detectors as the spray evaporates completely without residues.

The spray can be used wherever photoelectric smoke detectors are employed, for example in industrial plants, public facilities and private households.

- ▶ 150 ml ▶ 250 ml
- 11640150 11640250



Smoke Detector Test Spray non-flammable **NEW**

Low flammability | silicone-free | residue-free evaporation

The test spray is ideal to quickly and reliably test the functionality of optical or photoelectric smoke detectors. The use of the low-flammability test aerosol does not soil the smoke detectors, as the spray evaporates completely without leaving any residue.

WEICON Smoke Detector Test Spray non-flammable is very easy to apply and can be used wherever photoelectric smoke detectors are installed – for example in the shipping industry, in industrial plants, public institutions or private households.

- ▶ 250 ml
- 11641250



Adhesives / Sealants

Technical Sprays

Technical Liquids

Assembly Pastes

Lubricants

WEICON TOOLS®

Other



Starter-Spray

For all combustion engines

WEICON Starter Spray is suitable for the easy and safe starting of combustion engines. The safe cold starting of all engines is made possible by a special combination of ingredients.

Starter Spray is ideal at low temperatures, in damp weather or after longer engine downtimes. The spray protects both the engine and the battery. Starter Spray is suited for both diesel and petrol engines. Whether with or without a catalytic converter, whether a motor vehicle, construction machinery, agricultural machinery, chain saws, lawn mowers, boat engines, motorcycles or scooters – WEICON Starter Spray can be used everywhere.

- ▶ 400 ml
- 11660400



Freeze Spray

Precise chilling down to -45°C (-49°F)

WEICON Freeze-Spray has many uses and is suitable for fault-finding in electronics and for repair works in industrial sector.

Freeze Spray quickly cools parts down to -45°C (-49°F) and allows pin-pointed chilling of even the smallest construction parts.

WEICON Freeze Spray is non-conductive and neutral to materials (with the exception of plastic) and can be used in many industrial and technical applications.

- ▶ 400 ml
- 11610400



Silicone-Fluid

Nonfood Compounds
Program Listed H1
Registration 10278

Excellent sliding and separating effect |
temperature resistance from -30°C to
+250°C (-22°F to +482°F)

▶ 400 ml
11351400



Rust Loosener Fluid

Nonfood Compounds
Program Listed H1
Registration 10287

Penetrates into the smallest cavities |
secures the function of mechanical
parts and electrical contacts | protects
against corrosion and oxidation

▶ 400 ml
11154400



Spray-on Grease H1

Nonfood Compounds
Program Listed H1
Registration 14583

High-temperature-resistant |
odour- and tasteless |
NSF-H1 registration

▶ 400 ml
11541400



Metal-Fluid

Nonfood Compounds
Program Listed A7 C1
Registration 12124

For matt and polished surfaces |
for stainless steel, ceramics, glass,
plastics, wood | NSF-A7; C1 registration

▶ 400 ml
11580400



PTFE-Fluid

Nonfood Compounds
Program Listed H2
Registration 10329
NO FOOD CONTACT

Repels dirt, dust and water | resistant
against oils, greases and many
chemicals | NSF-H2 registration

▶ 400 ml
11301400



Foam Cleaner

Nonfood Compounds
Program Listed A1
Registration 12115

Special cleaner for the food
industry | universally applicable |
NSF A1 registration

▶ 400 ml
11209400



Bio-Fluid

Nonfood Compounds
Program Listed H1
Registration 12816

High lubricating effect and good
capillary action | high-purity medical
white oil | NSF-H1 registration

▶ 500 ml
11600500



Fast Cleaner

Nonfood Compounds
Program Listed A1
Registration 10478

pH-neutral and material-compatible |
can be used on many different materials
such as metals, glass, ceramics and most
rubbers and plastics | NSF-A1 registration

▶ 500 ml
11212500



Industrial Cleaner

Nonfood Compounds
Program Listed E1 E2
Registration 14584

Powerful special cleaner
with high yield

▶ 500 ml
11215500



Top-Lube-Fluid

Nonfood Compounds
Program Listed H2
Registration 10217
NO FOOD CONTACT

Particularly adherent and pressure-
resistant | noise-dampening
and water-repellent | prevents
elongation, friction and wear

▶ 400 ml
11512400



W 44 T®-Fluid

Nonfood Compounds
Program Listed H1
Registration 10218

Resin- and acid-free | excellent
capillary action | lubrication, water
repellency, corrosion protection,
cleaning and conservation
in one product

▶ 400 ml
11253400



Anti-Seize High-Tech

Nonfood Compounds
Program Listed H1
Registration 14188

White assembly paste, high-
temperature-resistant | metal-free |
NSF-H1 registration

▶ 400 ml
27050400



Zinc Spray

Nonfood Compounds
Program Listed H1
Registration 10489

Long-term cathodic corrosion
protection | paintable | >1050
in the salt spray test according
to DIN EN ISO 9227

▶ 400 ml
11000400



Zinc Spray bright grade

Nonfood Compounds
Program Listed H1
Registration 10489

Long-term cathodic corrosion
protection | bright colour shade
matching hot-dip galvanization

▶ 400 ml
11001400



**Stainless Steel Care
Spray A7 NEW**

Nonfood Compounds
Program Listed A7
Registration 16024

Special spray for cleaning, care and
protection of brushed, matt and polished
stainless steel surfaces in sensitive areas

▶ 400 ml
11591400

Adhesives / Sealants

Technical Sprays

Technical Liquids

Assembly Pastes

Lubricants

WEICON TOOLS®

Other

Technical Sprays for Sensitive Areas



Technical Sprays

for sensitive areas

With our selection of chemo-technical products with food certifications, we ensure that you get the right products for your production, maintenance and repair which meet your exact requirements quality- and safety-wise.

We have developed a variety of special products for the most different applications which meet the high standards of the National Sanitation Foundation (NSF). These products can be used in sensitive areas such as food production, food and beverage industry and the pharmaceutical and cosmetic industry. Here our adhesives and sealants, assembly pastes or cleaners can be applied in the different areas of production.



Universal Spatula white

10953008

Special spatula for the gentle removal of the most diverse contamination and residues. Suitable for use in the food industry.

EU Regulation 10/2011/EC plastics with food contact.



Lubricants, Release Agents and Anti-Corrosion Agents

H1	Lubricants for use in food processing areas where accidental contact with food cannot be prevented.	Anti-Seize High-Tech Bio-Fluid (Spray, Technical liquid) Silicon-Fluid Spray-on Grease H1 Rust Loosener-Fluid W 44 T [®] -Fluid
H2 <small>NSF FOOD CONTACT</small>	Lubricants exclusively for areas in which direct or indirect contact with food can be ruled out.	PTFE-Fluid Top-Lube-Fluid
R2	Coatings for use on structural surfaces, which do not come into contact with food. The product must be applied in a way that prevents direct or indirect contamination of food.	Zinc Spray Zinc Spray bright grade

Cleaning Agents

A1	Universal cleaner exclusively for areas in which direct contact with food can be ruled out. Surfaces and equipment must be rinsed thoroughly with drinking water after cleaning.	WEICON Fast Cleaner (Spray, Technical liquid) WEICON Foam Cleaner
A7	Cleaning agent and polishes for metal surfaces without food contact. Odours must be dissipated completely before contact with food or packaging may occur.	WEICON Metal-Fluid (Spray, Technical liquid) WEICON Stainless Steel Care Spray A7
C1	Cleaner for use in non-food processing areas. Cleaned equipment must be rinsed thoroughly with drinking water before it is returned to food areas.	WEICON Metal-Fluid (Spray, Technical liquid)
K1 K3	Solvent cleaner and degreaser for use in non-food processing areas. Solvent adhesive or glue remover without direct food contact.	WEICON Industrial Cleaner (Spray)

Adhesives / Sealants

Technical Sprays

Technical Liquids

Assembly Pastes

Lubricants

WEICON TOOLS[®]

Other



Technical Data

	Colour	Odour	Temp. resistance	Content	Shelf life (months)	Special features
Adhering Grease extra strong	beige	almost odourless	-25°C (-13°F) to +80°C (+176°F)	400 ml	24	adhering even under water
Adhesive Spray	beige	solvent	-20°C (-4°F) to +65°C (+149°F)	500 ml	12	large surface bonding of light materials
Adhesive Spray extra strong	yellowish	solvent	-20°C (-4°F) to +80°C (+176°F)	500 ml	12	bonding of big surfaces, even with absorbing materials
Adhesive Spray for detachable joints	colourless	solvent	-20°C (-4°F) to +50°C (+122°F)	500 ml	12	does not strike through nor leaves wavy surfaces
Allround Sealing Spray	grey	solvent	-50°C (-58°F) to +100°C (+212°F)	400 ml	24	seals reliably and quickly
Alu Grinding Protection	colourless	solvent	-20°C (-4°F) to +130°C (+266°F)	400 ml	24	silicone-free
Anti-Friction Spray MoS2	anthracite black	solvent	-200°C (-328°F) to +450°C (+842°F) briefly to +500°C (+932°F)	400 ml	24	dry lubricant on MoS2 basis
Anti-Seize High Tech	white	medical white oil	-40°C (-40°F) to +1.400°C (+2.552°F)	400 ml	24	perfect protection against the seizing of high-alloy steels, NSF H1
Anti-Seize Assembly Spray	anthracite	synthetic oil mixture	-180°C (-292°F) to +1.200°C (+2.192°F)	400 ml	24	extremely high pressure resistance, corresponds to MIL907D
Anti-Spatter Spray	colourless	solvent	---	400 ml	24	silicone-free
AT-44 Allround-Spray	yellowish	vanilla	-50°C (-58°F) to +210°C (+410°F)	150 ml 400 ml	24	high-performance lubricating oil with PTFE
Belt Dressing Spray	colourless	mineral oil	-40°C (-40°F) to +80°C (+176°F)	400 ml	24	suitable for highly-stressed powertransmission belts
Bio-Cut	colourless	almost odourless	to +200°C (+392°F)	400 ml	12	completely biodegradable
Bio-Fluid	colourless	almost odourless	-25°C (-13°F) to +120°C (+248°F)	500 ml	24	corresponds to purity grade of DAB10, USDA H1, FDA Regulations, FDA positive list
Brake Cleaner	colourless	citrus	---	500 ml	24	evaporates without residues
Burner Cleaner	colourless	citrus	---	500 ml	24	evaporates without residues
Ceramic Anti-Spatter Spray	white	solvent	---	400 ml	24	excellent adhesion
Chain and Rope Lube Spray	colourless	mineral oil	-40°C (-40°F) to +200°C (+392°F)	400 ml	24	particularly adhesive, pressure-resistant, extremely high capillary action, sound-absorbent
Chewing Gum Remover	---	almost odourless	---	400 ml	24	removes even old chewing gum or modelling clay residues
Citrus Cleaner	colourless	citrus	---	400 ml	24	evaporates without residues, pH neutral
Cleaner Spray S	colourless	orange	---	500 ml	24	evaporates without residues
Cockpit-Spray	colourless	citrus	---	400 ml	24	dust- and water-repellent colour-intensifying, silk-matt
Compressed-Air Spray	---	almost odourless	---	400 ml	24	cleans in a contact-free manner
Contact Spray	transparent	solvent	-20°C (-4°F) to +150°C (+302°F)	400 ml	24	dispels moisture, protects electrical contacts
Copper Paste Assembly Spray	copper	mineral oil	-20°C (-4°F) to +1.100°C (+2.012°F)	400 ml	24	high temperature resistant
Corro-Protection	milky	solvent	-20°C (-4°F) to +80°C (+176°F)	400 ml	24	on a wax basis
Crack Testing Agent Cleaner	colourless	solvent	0°C (+32°F) to +50°C (+122°F)	500 ml	24	evaporates without residues
Crack Testing Agent Developer	white	solvent	0°C (+32°F) to +50°C (+122°F)	500 ml	24	reliable indication of material errors
Crack Testing Agent Penetrant	red	solvent	0°C (+32°F) to +50°C (+122°F)	500 ml	24	very good penetration properties
Electro Contact Cleaner	colourless	solvent	---	400 ml	24	high-purity solvents
Fast Cleaner	colourless	solvent	-10°C to +50°C (+14°F to +122°F)	400 ml	24	NSF-A1 approval
Fitting Spray	colourless	odourless	-25°C (-13°F) to +120°C (+248°F)	200 ml	24	resin- and acid-free mineral oil
Foam Cleaner	white	odourless	---	400 ml	24	NSF-A1 approval
Freeze Spray	---	almost odourless	---	400 ml	24	targeted cooling of even the smallest components down to -45°C (-49°F)
Hand Protective Foam	white	odourless	---	200 ml	24	with liposomes, dermatologically tested
Industrial Cleaner	colourless	solvent	---	500 ml	24	high performance, 95 % active ingredient content, NSF-K1,K3 approval

Technical Sprays

Technical Data

	Colour	Odour	Temp. resistance	Content	Shelf life (months)	Special features
Isolation Spray	colourless	solvent	-40°C (-40°F) to +120°C (+248°F)	400 ml	24	high dielectric strength, material-compatible
Label Remover	colourless	citrus	---	500 ml	24	removes paper and foil labels with special spatula
Leak Detection Spray	milky	almost odourless	-15°C (+5°F) to +50°C (+122°F)	400 ml	24	DVGW-tested
Leak Detection Spray frost-proof	colourless	almost odourless	-15°C (+5°F) to +40°C (+104°F)	400 ml	24	DVGW-tested; frost-proof
Leak Detection Spray viscous	colourless	almost odourless	0°C (+32°F) to +50°C (+122°F)	400 ml	24	non-sag
Metal-Fluid	milky	almost odourless	---	400 ml	24	antistatic effect, NSF-A7, C1 approval
Mould Cleaner	colourless	citrus	---	500 ml	24	removes waxes, oils, silicones and other impurities from moulds and tools
Mould Release Agent	colourless	solvent	-20°C (-4°F) to +130°C (+266°F)	400 ml	24	silicone-free
Multi-Foam	white	citrus	---	400 ml	24	biodegradable
Parts and Assembly Cleaner	colourless	mineral oil	---	500 ml	24	high flash point (>+60°C/+140°F)
Plastic-Cleaner	colourless	citrus	---	500 ml	24	for sensitive plastic surfaces
Pneuma-Lube	yellowish	vanilla	-50°C (-58°F) to +210°C (+410°F)	400 ml	24	high-performance lubricating oil with PTFE
PTFE-Fluid	whitish, transparent	almost odourless	-180°C (-292°F) to +260°C (+500°F)	400 ml	24	NSF-H 2 approval
PTFE-Spray	white	almost odourless	-180°C (-292°F) to +250°C (+482°F)	400 ml	24	dry lubricant on a PTFE basis
Rust Converter	beige, transparent	synthetic resin	-50°C to +80°C (-58°F to +176°F) (briefly <15 min. to +180°C/+320°F)	400 ml	24	rust converting, priming, sealing
Rust Loosener and Contact Spray	beige	petroleum	-20°C (-4°F) to +150°C (+302°F)	400 ml	24	sixfold function
Rust Loosener Fluid	beige	almost odourless	-20°C (-4°F) to +150°C (+302°F)	400 ml	24	loosens, lubricates, cleans and protects, NSF H1 approval
Rust-Shock	transparent	solvent	---	400 ml	12	removes rusted-tight screw connections of any type in seconds
Screen Cleaner	white	almost odourless	---	200 ml	24	also suitable for sensitive plastic and glass surfaces
Sealant and Adhesive Remover	pink	solvent	---	400 ml	18	powerful
Silicone Spray	colourless	solvent	-50°C (-58°F) to +250°C (+482°F)	400 ml	24	silicone oil basis
Silicone-Fluid	colourless	odourless	-30 to +250°C (-22 to +482°F)	400 ml	24	NSF-H1 approval
Smoke Detector Test Spray	colourless	solvent	---	150 ml 250 ml	24	silicone-free, evaporates without residues
Smoke Detector Test Spray non-flammable	colourless	alcohol	---	250 ml	24	low flammability, silicone-free, residue-free evaporation
Spray-on Grease H1	yellowish-white	almost odourless	-40°C (-40°F) to +160°C (+320°F)	400 ml	24	odour- and tasteless high-temperature grease, NSF-H 1 approval
Spray-on Grease white	white	solvent	-20°C (-4°F) to +150°C (+302°F)	400 ml	24	very good adhesive and lubricating properties
Stainless Steel Care Spray	colourless	almost odourless	-20°C (-4°F) to +130°C (+266°F)	400 ml	24	antistatic effect, indoors and outdoors
Stainless Steel Care Spray A7	colourless	almost odourless	-5°C (+ 23°F) to +200°C (+392°F)	400 ml	24	antistatic effect, NSF-A7 approval
Starter-Spray	colourless	solvent	---	400 ml	24	for all combustion engines
Surface Cleaner	colourless	solvent	---	400 ml	24	before the application of WEICON Adhesives and Sealants
Top-Lube	colourless	mineral oil	-40°C (-40°F) to +200°C (+392°F)	400 ml	24	particularly adhesive, pressure-resistant, and water-repellent. With excellent capillary action
Top-Lube-Fluid	light yellowish	neutral	-20°C to +250°C (-4°F to +482°F)	400 ml	24	synthetic, transparent, NSF H2 approval
Universal Spray on Grease with MoS ₂	black	almost odourless	-20°C (-4°F) to +120°C (+248°F)	400 ml	24	high-pressure-resistant, long-term grease
Visor Cleaner	white	almost odourless	---	200 ml	24	cleaning without residues and neutral to surfaces
W 44 T [®] Multi-Spray	yellowish	vanilla	-50°C (-58°F) to +210°C (+410°F)	200 ml, 400 ml, 500 ml	24	multifunctional oil with multiple effect
W 44 T [®] -Fluid	beige	almost odourless	-20°C to +150°C (-4°F to +302°F)	400 ml	24	loosens, lubricates, protects, separates and maintains, NSF H1 approval

Surface- and Anti-Corrosion Coatings

Product	Page
Aluminium Paint	162
Brushable Zinc Paint	162
Brushable Zinc Coating	162
Rust Converter	163
Corro-Protection	163

Cleaners and Degreasers

Surface Cleaner	164
Mould Cleaner	164
Electro Contact Cleaner	164
Cleaner M	164
Fast Cleaner	165
Sealant and Adhesive Remover	165
Cleaner S	165
Brake Cleaner	166
Plastic-Cleaner	166
Parts and Assembly Cleaner	166
Workshop Cleaner	167
Citrus Cleaner	167

Protection and Care

Stainless Steel Care	168
Metal-Fluid	168

Solvents and Release Agents

Rust Loosener	170
Label Remover	170
Mould Release Agent	171
Bio-Welding Protection (Anti-Spatter)	171



Lubricating and Multifunctional Oils

Product	Page
W 44 T®	173
AT-44	173
Bio-Fluid	174
Bio-Cut	174
Silicone	175
Pneuma-Lube	175

Other

Leak Detector	176
Adhesive Spray Liquid	176
Accessories	177

Technical Liquids

WEICON Technical Liquids

Environmentally friendly | economical | effective

Environmental protection, economic efficiency and health and safety at work - these are all requirements which every company has to fulfil to an increasing degree. That is why products and production systems that reach these requirements are becoming all the more important.

WEICON Technical Liquids meet the highest demands:

- ▶ they contain no flammable propellants
- ▶ no extensive or costly disposal is necessary
- ▶ emissions are reduced
- ▶ less packaging waste
- ▶ only the substance itself is processed



WEICON Technical Liquids are available for the following areas of application:

- ▶ cleaning and degreasing
- ▶ lubrication, care and maintenance
- ▶ release and separating
- ▶ surface and anti-corrosion coatings

Aluminium Paint***Effective | abrasion-resistant**

Aluminium Paint is used as corrosion protection and for the optical enhancement of metallic surfaces. Upon contact with moisture, aluminium pigments form a dense, almost impermeable oxide layer on the surface which prevents further moisture penetration.

High abrasion resistance and a long colour shade guarantee are achieved by pigments which evenly distribute themselves throughout the entire coating upon application.

This protects WEICON Aluminium Paint against abrasion and chemical effects after it has thoroughly hardened.

▶ 375 ml ▶ 750 ml
15002375 15002750

**Brushable Liquid Zinc Coating*****Repair for galvanized surfaces with a colour shade matching hot-dip galvanization**

WEICON Brushable Liquid Zinc Coating provides active protection against corrosion for all metallic surfaces and is available in a colour shade matching the galvanization.

With Brushable Liquid Zinc Coating, flaky metal pigments settle parallel to the surface in several, spatially displaced layers on the substrate (shingle effect). This protects the surface longer from penetrating moisture. Optimal corrosion protection is achieved in connection with the simultaneous electro-chemical effect.

▶ 375 ml ▶ 750 ml ▶ 2,5 L
15001375 15001750 15001902

**Brushable Liquid Zinc Paint*****Efficient cathodic corrosion protection**

WEICON Brushable Liquid Zinc Paint is a coating used to actively and permanently protect metallic substrates against corrosion.

Brushable Liquid Zinc Paint uses high concentration and pure spherical (round) metal pigments. The high amount of zinc in the coating ensures efficient cathodic corrosion protection.

If the surface is damaged, the zinc molecules react with the air humidity to form zinc oxide molecules which protect the base material from corrosion.

▶ 375 ml ▶ 750 ml ▶ 2,5 L
15000375 15000750 15000902



Surface and Anti-Corrosion Coatings

Corro-Protection

Corrosion protection for indoor storage and overseas shipment of metals

WEICON protective film approved by the German TÜV. It lastingly preserves tools and precision components with a dry and waxy layer.

WEICON Corro Protection can be used as safe corrosion protection for bare, unpainted metal parts, for the indoor storage of work pieces, as corrosion protection during overseas transport and for the conservation of tools and precision components. The protective layer can be removed easily (e.g. with WEICON Cleaner S).



▶ 1 L	▶ 5 L	▶ 10 L	▶ 28 L
15550001	15550005	15550010	15550028

Rust Converter*

Rust converter and base coat in one process

WEICON Rust Converter is used for the effective neutralization of rust on rusty cast iron and steel surfaces.



Rust Converter reliably stops the corrosion process and thus provides a base coat for subsequent surface coatings. Due to its special formula, Rust Converter penetrates rust and converts iron oxides into a stable, black layer in a chemical process.

It can be applied to all rusty areas, e.g. on machines and plants, agricultural equipment as well as motor vehicles.

▶ 1 kg	▶ 5 kg	▶ 10 kg	▶ 28 kg
15152001	15152005	15152010	15152028



* Not to spray with WSD 400 and WPS 1500. Just for application with paint brush / paint roller.



Surface Cleaner

Pre-treatment of bonding surfaces

WEICON Surface Cleaner is used for the cleaning and degreasing of surfaces to be joined or sealed with WEICON Adhesives and Sealants.

Surface Cleaner can be applied to materials like metal, glass, ceramics and most plastics.

WEICON Surface Cleaner can be used, for example, to clean and degrease machine components in the course of maintenance work.

- ▶ 1 L ▶ 5 L ▶ 10 L ▶ 28 L
- 15207001 15207005 15207010 15207028



Adhesives / Sealants

Technical Sprays

Electro Contact Cleaner

Cleans and degreases electronic or mechanical components

WEICON Electro Contact Cleaner is a special cleaner for the fast and effective cleaning and degreasing of all kinds of soiled or corroded contacts.

WEICON Electro Contact Cleaner was specially developed for the cleaning of electrical and mechanical components. The special formula with high-purity solvents removes oxide/ sulphide layers, combustion residues and resinous or sooty soiling. WEICON Electro Contact Cleaner reduces voltage loss and increases electric conductivity.

Contamination that can cause tracking current is removed. It can be used on electrotechnical or mechanical components such as electrical machines, measuring instruments, tools, balances, switches and sensors or electrical connections, contacts, relays and switchboards.

- ▶ 1 L ▶ 5 L ▶ 10 L ▶ 28 L
- 15212001 15212005 15212010 15212028



Technical Liquids

Assembly Pastes

Lubricants

WEICON TOOLS®

Other

Mould Cleaner

Cleaner on the basis of highly active organic solvents

WEICON Mould Cleaner is a special cleaner based on highly active organic solvents. It effectively removes waxes, silicones, oils, non-cured PUR residues and other impurities from plastic, steel or aluminium moulds.

- ▶ 1 L ▶ 5 L ▶ 10 L ▶ 28 L
- 15203501 15203505 15203510 15203528



Cleaner M NEW

Classified as non-hazardous | fast-drying | non-flammable

WEICON Cleaner M cleans and degreases all metals, plastics, rubber, glass, ceramic, wood, or painted and coated surfaces. It is powerful and precise in cleaning grease, oil, resin, soot, wax, release agents, forming substances, cooling lubricants as well as label and adhesive residues.

Cleaner M is ready to use, fast-drying, non-flammable and classified as non-hazardous. The cleaner is easy and safe to use. It can be used, for example, to clean and degrease machine components and tools. Its special formula consisting of special surfactants and alcohols does not contain any silicone defoamers, is non-greasy and therefore contributes significantly to the process-safe cleaning of components in production processes.

- ▶ 1 L ▶ 5 L ▶ 10 L ▶ 28 L
- 15225001 15225005 15225010 15225028



Technical Liquids

Cleaners and Degreasers

Fast Cleaner



Cleaning and degreasing agent for sensitive areas

The Fast Cleaner has an NSF registration for the foodstuffs sector and can therefore be used as a cleaner and degreasing agent for the removal of contamination generated within the scope of maintenance work and for the removal of noncured adhesive residues in the foodstuffs and beverages industry and in the pharmaceutical and cosmetic industries.

Fast Cleaner is used to clean and degrease surfaces which are bonded or sealed using WEICON adhesives and sealants, or which should be coated using WEICON metal sprays.

Fast Cleaner is pH-neutral and materialcompatible, and can be used on many different materials such as metals, glass, ceramics and most rubbers and plastics. Due to its special formula and the resulting NSF registration, the Fast Cleaner can contribute towards improvements in occupational safety and health protection.

▶ 1 L ▶ 5 L ▶ 10 L ▶ 28 L
 15215001 15215005 15215010 15215028

Sealant and Adhesive Remover*

Removes residues of cured sealants and adhesives

WEICON Sealant and Adhesive Remover quickly and easily removes residues of cured sealants and adhesives as well as lacquers and paints, even from vertical surfaces. Sealant and Adhesive Remover can be used on metal, wood, glass, ceramics, polyethylene and polypropylene. It should not be used on sensitive plastics such as PVC, synthetics, linoleum, etc.

▶ 1 L ▶ 5 L ▶ 10 L ▶ 28 L
 15213001 15213005 15213010 15213028

* Not to spray with WSD 400 and WPS 1500. Just for application with paint brush / paint roller.



Cleaner S

Degreases and cleans all metals, glass, ceramics and most plastics

WEICON Cleaner S cleans, degreases and evaporates without leaving residues. It can be used on all metals, glass, and ceramics, and on most plastics, and thermoplastics such as PVC, PMMA (acrylic glass), polystyrene etc. WEICON Cleaner S can be used for cleaning and degreasing before priming and painting, for cleaning machine parts or before other WEICON products are applied on surfaces where a greasy underground would impair their effect.

▶ 1 L ▶ 5 L ▶ 10 L ▶ 28 L
 15200001 15200005 15200010 15200028





Brake Cleaner

Multi-purpose cleaner, especially for the automotive sector

WEICON Brake Cleaner is a universal cleaner for the automotive industry, which cleans, degreases and evaporates without leaving residues.

WEICON Brake Cleaner quickly and effortlessly degreases and cleans metals, glass and many plastics. It removes oily and greasy impurities and residues.

Brake Cleaner can be used on brakes (drum and disc brakes, brake pads, brake blocks, cylinders, springs and bushings), clutches (clutch linings and components) and on engine parts (carburettors, fuel and oil pumps, gears etc.).



- ▶ 1 L ▶ 5 L ▶ 10 L ▶ 28 L
- 15201001 15201005 15201010 15201028

Plastic-Cleaner

Degreases and cleans sensitive surfaces

WEICON Plastic-Cleaner cleans, degreases and evaporates without leaving residues. It can be used to clean and degrease sensitive surfaces such as plastics*, rubber materials or powdercoated metal parts.



Plastic-Cleaner can be used, for example, on window frames, roller blinds, plastic profiles, seals or lacquered flanges in many industrial applications.

- ▶ 1 L ▶ 5 L ▶ 10 L ▶ 28 L
- 15204001 15204005 15204010 15204028

*Before use, check surface compatibility

Parts and Assembly Cleaner

Specially developed cleaner with a high flash point (> +60°C/+140°F of the agent)

WEICON Parts and Assembly Cleaner is a specially developed cleaner with a high flashpoint (> +60°C/+140°F of the active ingredient) and a long working time for the removal of coarse, oily, resinified and greasy contamination.

Due to its high flashpoint, WEICON Parts and Assembly Cleaner conforms to the former VbF classification AIII (VbF = Regulation concerning flammable liquids) and complies with the recommendations of the professional associations for safety at work. It quickly and thoroughly cleans all kinds of assembly parts, aggregates, construction parts and tools. It removes oils, greases, dirt, etc., from all metal parts and cleans brakes, clutches, engine parts, etc. in the automotive sector.

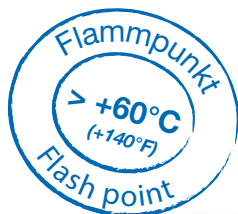

- ▶ 1 L ▶ 5 L ▶ 10 L ▶ 28 L
- 15211001 15211005 15211010 15211028

Technical Liquids Cleaner and Degreaser

Workshop Cleaner

Free of solvents and phosphate | bio-degradable

Workshop Cleaner cleans and degreases all metals, plastics, types of rubber, glass, ceramics and wood. It removes grease, oil, resin, rust, wax, nicotine, insect dirt, bitumen and tar specks.



Workshop Cleaner is free of solvent, emulsifier and phosphate compatible with oil separators (ÖNORM B 5105) and, in accordance with EC-guidelines, biodegradable. It is highly concentrated and can be diluted to the proportion 1:40 (max.).

Workshop Cleaner contains selected foamless tensides and, in addition to manual cleaning, can be used in high-pressure cleaners, part washing machines and spray apparatuses (e.g. Pump Dispenser WPS 1500).

- ▶ 500 ml* ▶ 1 L ▶ 5 L ▶ 10 L ▶ 28 L
- 15205500 15205001 15205005 15205010 15205028

*Can only be applied with the WPS 1500

Recommended application concentration

	undiluted	1:10	1:20	1:30	1:40
Aluminium parts					•
Inspection pits		•			
Grease, soot, bitumen and tar splashes	•				
Chromium, stainless steel and plastic				•	
Diesel residue	•				
Insect dirt		•			
Industrial floors, forklift trucks				•	
Hard floors		•			
Lorries (also tarred canvases)		•			
Machines, engines, oil/oil residues		•			
Repair parts					•
Steel degreasing			•		
Workshop equipment				•	
Machine tools				•	

Citrus Cleaner



proven effect according to DIN EN 1276 and 1650

Cleaner and degreaser on the basis of citrus essences

WEICON Citrus Cleaner is an all-purpose cleaning agent based on alcohol and citrus peel extracts. Due to its high isopropyl alcohol content of over 75%, WEICON Citrus Cleaner makes use of its disinfectant effect, and thus supports the overall cleaning and disinfection of surfaces. It can be used for all purposes and is equally suited for use in industrial applications, skilled trades, window construction, in public institutions and public transport, in construction companies, and in housekeeping. It cleans a wide range of materials, such as metals and plastics, glass, and ceramic as well as painted and coated surfaces*.

WEICON Citrus Cleaner is also highly effective and efficient in basic hygiene and supporting additional hygiene measures, in cleaning frequently used hand tools, and in removing stains due to pencils, pens, and markers.

- ▶ 1 L ▶ 5 L ▶ 10 L ▶ 28 L
- 15210001 15210005 15210010 15210028

*For safety reasons, the material compatibility should first be checked on a nonvisible area.



Stainless Steel Care

Antistatic effect

Stainless Steel Care was specially formulated for the cleaning, protection and care of matt and polished stainless steel surfaces both indoors and outdoors and has an antistatic effect.



WEICON Stainless Steel Care removes and prevents fingerprints, removes lubricating films e.g. from fume hoods, cleans even large surfaces without leaving streaks, and provides a long-lasting protective film which repels water and prevents new dirt from clinging. The product can be used in many applications.

- ▶ 1 L ▶ 5 L ▶ 10 L ▶ 28 L
- 15590001 15590005 15590010 15590028



Metal-Fluid

Universal use; clean | maintain | protect

WEICON Metal-Fluid is a care and cleaning product for indoor matt and polished surfaces and has an NSF registration.

Metal-Fluid protects, cleans and maintains both metal surfaces and ceramics, wood, glass and plastics. It does not dissolve etched and printed markings or plastic surfaces and rubber seals.

- ▶ 100 ml ▶ 500 ml ▶ 1 L ▶ 5 L ▶ 10 L ▶ 28 L
- 15580100 15580500 15580001 15580005 15580010 15580028



Technical Liquids
**Protection
 and Care**



WEICON Pump Dispenser

For approx. 500 ml solvent- and mineral oil-free WEICON Technical Liquids.

15842001



WEICON Pump Dispenser "Special"

For approx. 500 ml WEICON Cleaner S, Brake Cleaner and Rust Loosener.

15843001

Adhesives / Sealants
 Technical Sprays
 Technical Liquids

Simply find solutions.



weicon.de/app



Assembly Pastes
 Lubricants
 WEICON TOOLS®
 Other



Rust Loosener

Sixfold function

WEICON Rust Loosener's sixfold function makes it indispensable for repairs, maintenance and servicing. Thanks to its excellent capillary action, WEICON Rust Loosener reaches even the smallest cavities.

WEICON Rust Loosener loosens rusted and stiff parts, screws, bolts, joints and hinges, permanently protects against corrosion and oxidation, durably lubricates sliding surfaces, cleans and maintains metallic surfaces and mechanical parts and is temperature-resistant from -20°C to +150°C (-4 to +302°F).



▶ 1 L	▶ 5 L	▶ 10 L	▶ 28 L
15150001	15150005	15150010	15150028

Label Remover

Simple and fast

WEICON Label Remover quickly and easily removes paper labels and residues of acrylate and caoutchouc-based pressure-sensitive adhesives.

Label Remover is suitable for many surfaces such as glass, metal, wood, foil and plastic. WEICON Label Remover easily and safely removes adhesive labels, price tags (e.g. incorrect labels), address and product stickers, identification labels, and label residues. It also removes adhesive residues from foil labels such as vignettes on car windshields.

▶ 1 L	▶ 5 L	▶ 10 L	▶ 28 L
15206001	15206005	15206010	15206028

Solvents and Release Agents



Mould Release Agent

Silicone-free sliding and release agent

The high-grade combination of active ingredients, consisting of pure natural products, has a high sliding effect which prevents its adhesion to plastics, moulds, metals and tools.

WEICON Mould Release Agent can be used in plastic processing and for spraying, pressing, and vacuum deforming.

- | | | | |
|----------|----------|----------|----------|
| ▶ 1 L | ▶ 5 L | ▶ 10 L | ▶ 28 L |
| 15450001 | 15450005 | 15450010 | 15450028 |



Bio Welding Protection

Silicone-free

WEICON Bio Welding Protection provides temporary corrosion protection. It contains no chlorinated hydrocarbons, other solvents or silicones.

Bio Welding Protection is based on hazel nut and sunflower extracts and is biodegradable in accordance with EC Directives.

WEICON Bio Welding Protection prevents the adhesion of weld spatter to gas nozzles and work-piece surfaces without affecting the quality of the weld seam.

- | | | | |
|----------|----------|----------|----------|
| ▶ 1 L | ▶ 5 L | ▶ 10 L | ▶ 28 L |
| 15050001 | 15050005 | 15050010 | 15050028 |





WEICON

W 44 T

**lös - verbringt - befeuchtet
reinigt - schützt - pflegt**

W 44 T

**loosens - displaces - eliminates
cleans - protects - preserves**

5 l 10 l 28 l

Art. No. 1525 1008 Art. No. 1525 1010 Art. No. 1525 1028

WEICON GmbH & Co. KG
 Hauptstraße 20 · 330
 48157 Münster (Germany)
 Tel. +49 521 492 310

Made in the E.C.

www.weicon.com

DE: W 44 T Multi-Use ist eine Anwendung in allen Industrie- und Werkstattbereichen. Durch seine spezielle Rezeptur und seine konzentrierten Wirkstoffeigenschaften werden Entrostmittel, Reinigungs-, Pflegemittel, Schmiermittel und Konservierungsmittel ersetzt.

W 44 T ist ein universelles Lösungsmittel und Feuchthaltemittel für alle Werkstoffe (Metalle, Kunststoffe, Holz, Glas, Keramik, Stein, etc.).

Eigenschaften:
 Das Multi-Use-Produkt (Pflanz- und Schutzmittel) ist ein Multi-Use-Produkt, das alle Eigenschaften von Reinigungs-, Pflegemittel, Schmiermittel, Entrostmittel und Konservierungsmittel in sich vereint. Es ist ein universelles Lösungsmittel und Feuchthaltemittel für alle Werkstoffe (Metalle, Kunststoffe, Holz, Glas, Keramik, Stein, etc.).

Sicherheitsmerkmale:
 W 44 T Multi-Use ist ein universelles Lösungsmittel und Feuchthaltemittel für alle Werkstoffe (Metalle, Kunststoffe, Holz, Glas, Keramik, Stein, etc.).

DE: W 44 T Multi-Use ist ein universelles Lösungsmittel und Feuchthaltemittel für alle Werkstoffe (Metalle, Kunststoffe, Holz, Glas, Keramik, Stein, etc.).

Properties:
 W 44 T Multi-Use is a high-performance and very efficient cleaning and maintenance agent of latest technical solutions.

Properties:
 W 44 T Multi-Use is a high-performance and very efficient cleaning and maintenance agent of latest technical solutions.

Lubricating and Multifunctional Oils

W 44 T®

Multifunctional oil with multiple effects

W 44 T® is a multifunctional product which, thanks to its special formula and outstanding capillary action, combines corrosion protection, water repellency, lubrication, conservation and cleaning in a single product.

W 44 T® loosens seized threads, bolts, fittings and valves, penetrates and dissolves rust, dispels moisture from electrical contacts, prevents tracking currents and makes it easier to start wet motors. W 44 T® can also be used as cutting oil for drilling and cutting processes. It eliminates squeaky and creaky noises on hinges, guides, bearings and all types of joints and couplings. It cleans soiled metal surfaces and leaves a long-lasting, razor-thin film which does not smear or stick and does not attract dust.

It protects and preserves all types of tools, machines, and electrical and mechanical precision devices and keeps them functional. The use of WEICON W 44 T® has almost no limitations in workshop, automotive, shipping, electrical, agricultural, household and hobby applications.

▶ 1 L ▶ 5 L ▶ 10 L ▶ 28 L
 15251001 15251005 15251010 15251028



AT 44

With PTFE super power | silicone-free

Thanks to its special formula and very low friction coefficient, WEICON AT-44 combines corrosion protection, cleaning, water repellency, lubrication and conservation in a single product.

WEICON AT-44 loosens seized threads, bolts, fittings and valves, dispels moisture from electrical cables, prevents tracking currents and makes it easier to start wet motors. It eliminates squeaky and creaky noises on hinges, guides, bearings and all types of joints and couplings.

It cleans soiled surfaces and leaves a razor-thin film which does not smear or stick and does not attract dust. It protects and preserves all types of tools, machines, and electrical and mechanical precision devices and keeps them functional. The use of AT 44 has almost no limitations in workshop, automotive, shipping, electrical, agricultural, household and hobby applications.

▶ 1 L ▶ 5 L ▶ 10 L ▶ 28 L
 15250001 15250005 15250010 15250028





Bio-Fluid*



High-purity mineral oil

WEICON Bio-Fluid is a medically pure white oil containing no resins or acids which was specially developed for lubrication and care.



It is water-clear, free of solvents, odourless and tasteless, and water-repellent. It shows excellent capillary action and has an NSF registration.

It reduces friction and wear, suppresses squeaky noises, protects against corrosion and removes dirt and rust. Bio-Fluid can be used for the lubrication, protection and care of precision mechanisms, as a spray oil for production and filling plants, and as a lubricant for filling and packaging systems. It can be used wherever occasional, technically unavoidable contact with food or its packaging can occur.

- ▶ 1 L ▶ 5 L ▶ 10 L ▶ 28 L
- 15600001 15600005 15600010 15600028

* Not to spray with WSD 400 and WPS 1500. Just for application with paint brush / paint roller.

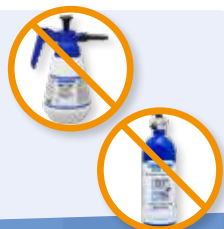

Bio-Cut*

Cutting oil for all steel grades

WEICON Bio-Cut is free of mineral oils and biodegradable. Thanks to its particularly high lubricating effect, it enables higher cutting speeds, a longer service life and thus higher performance of cutting tools.

WEICON Bio-Cut can be used for drilling, grinding, milling, grating, sawing, punching and reaming of all kinds of steel, cast iron, stainless steels, copper, brass, aluminium and their alloys in all areas of industry.

- ▶ 250 ml ▶ 1 L ▶ 5 L ▶ 10 L ▶ 28 L
- 15750002 15750001 15750005 15750010 15750028

*Can only be applied with the WSD 400



Lubricating and Multifunctional Oils



Silicone

Sliding and release agent

Silicone is an ideal sliding and release agent for efficient production and maintenance. It also serves as a protection and care product for plastic, rubber as well as metal and it is temperature-resistant up to +250°C (+482°F).



WEICON Silicone can be used in many industrial applications.

▶ 1 L ▶ 5 L ▶ 10 L ▶ 28 L
 15350001 15350005 15350010 15350028

Pneuma-Lube

Lubricant | corrosion protection | high content of PTFE

As a lubricating and corrosion protection agent, this product is the universal problem-solver for all moving parts in pneumatic equipment and accessories. Its special product formula with a high content of PTFE makes it a multi-purpose product for: lubrication, corrosion protection, cleaning, water displacing and conservation.



Pneuma-Lube not only serves in installation or maintenance of pneumatic equipment and accessories but also can be used on pneumatic tools in operation. The excellent weathering resistance allows the use also in other sectors, e.g. in the on- and offshore industry. The temperature resistance of the spray ranges from -50°C to +210°C (-58°F to 410°F).

▶ 1 L ▶ 5 L ▶ 10 L ▶ 28 L
 15260001 15260005 15260010 15260028



Leak Detector



DVGW-approval | foam-forming leak detector according to DIN EN 14291 | non-flammable | non-corrosive

The agent is used for the fast, convenient and reliable location of leaks (cracks or porous spots) in pressurized pipes.

WEICON Leak Detector does not form any hazardous compounds with carbon dioxide (CO₂), propane, butane, acetylene, oxygen, city or natural gases.

WEICON Leak Detector can be used wherever compressed air, natural or liquid gas is processed, and wherever leaky points can occur on fittings, threaded joints, and connections. It greatly contributes to the safety of pneumatic brakes and gas lines.

- ▶ 1 L ▶ 5 L ▶ 10 L ▶ 28 L
- 15400001 15400005 15400010 15400028



Leak Detector frost-proof



DVGW-approval | foam-forming leak detector according to DIN EN 14291 | non-flammable | non-corrosive | frost-proof up to -15°C (+ 5°F)

The safe, easy and quick way to find leaks or porous spots on gas pipes. Leak Detector frostproof does not form any harmful compounds with these gases: carbon dioxide (CO₂), propane, butane, acetylene, oxygen, coal and natural gas, nitrogen, dinitrogen monoxide (N₂O) and CFC and is non-flammable.

Leak Detector frost-proof is suitable wherever compressed air or gaseous substances are being used.

For example, it can be used on pipes, hoses, fittings, screw connections, valves and adapters.

- ▶ 1 L ▶ 5 L ▶ 10 L ▶ 28 L
- 15404001 15404005 15404010 15404028

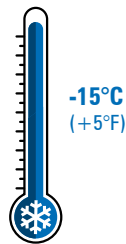

Leak Detector viscous



DVGW-approval | foam-forming leak detector according to DIN EN 14291 | non-flammable | non-corrosive | non-drip

WEICON Leak Detector viscous is the quick, easy and reliable way to find leaks in gas and compressed air pipes and fittings. The liquid does not form harmful compounds with the following gases: carbon dioxide (CO₂), propane, butane, acetylene, oxygen, coal and natural gas, nitrogen, dinitrogen monoxide (N₂O) and CFC and it is non-flammable.

Leak detector is applicable wherever compressed air or gaseous substances are being used. Typical application areas for the spray are pipes, hoses, fittings, screw connections, valves and adapters.

- ▶ 1 L ▶ 5 L ▶ 10 L ▶ 28 L
- 15403001 15403005 15403010 15403028



Adhesive Spray Liquid NEW

Versatile use | clean | easy application

WEICON Adhesive Spray is a high-grade adhesive containing solvents and based on synthetic caoutchouc. Depending on the way it is processed, it can be used both as contact and as assembly adhesive. The adhesive reliably bonds paper, cardboard, textiles, felt, wood, metals, leather, rigid foam, foam rubber, and many plastics.

The Adhesive Spray has a low viscosity, a short flash-off time and reaches its final strength after approx. 24 hours. The adhesive can be applied with a paint brush or a spray gun. WEICON Adhesive Spray is very versatile and suitable for industrial use and the skilled trades as well as for domestic use.

- ▶ 1 L ▶ 20 L
- 15800001 15800020

Technical Liquids

WSD 400 Pressurized-Air Spray Can

WSD 400 is a refillable spray for the application of most WEICON Technical Liquids.

The can is fillable with compressed air via an adapter (accessories) from the compressed-air ductwork system (optimum working pressure 7,5 bar).

The following accessories for WSD 400 are available:

- ▶ Adapter for filling from every compressed air system
- ▶ Valve set with four different valves and Ball pump with intake pipe



Pressurized-Air Spray Can WSD 400

15811400

Spray-valve set of 4 pieces

15811002

Adapter

15810001



Pump Dispenser WPS 1500

WPS 1500 is a refillable pump dispenser in which many WEICON Technical Liquids can be used. The building-up pressure in the fluid container is achieved by pumping pure air with the pump rod. An integrated security valve opens automatically as soon as the allowed pressure (max. 4 bar) has been exceeded.

Activation of the spray button is enough to achieve steady, uniform fluid emission. By turning the nozzle screw, the rate at which the spray is emitted and the sprayed amount can be smoothly regulated, from strong spray jet to fine spray mist.

The following accessories for WPS 1500 are available:

- ▶ 30 cm plastic extension with 0,8 mm diameter nozzle
- ▶ Sealing sets

Pump Dispenser WPS 1500 with EPDM-seals

15841500

Refillable plastic sprayer with special seals for approx. 1.300 ml Technical Liquid.

Seal set EPDM for Pump Dispenser WPS 1500

15841502

Pump Dispenser WPS 1500 with VITON-seals

15841500-V

Refillable plastic sprayer with VITON seal set especially for WEICON Rust Loosener, WEICON W44T and WEICON AT44

Seal set Viton for Pump Dispenser WPS 1500 V

15841503

Extension piece 30cm with nozzle

15841501



	WSD 400	WPS 1500
Container volume:	600 ml	1500 ml
Max. filling amount:	400 ml	1300 ml
Working pressure:	5 - 10 bar	4 bar
Explosion limit:	42 bar	---
Deformation pressure:	26 - 27 bar	---
Material:	Container and spray nozzle made of aluminium	Container made of non-breakable polyethylene; spray nozzle and devices made of polypropylene, fibre optic strengthened polyamide and stainless steel



Technical Data

	Brushable Liquid Zinc Paint	Brushable Liquid Zinc Coating	Aluminium Paint
Colour shade / level of brilliance:	zinc-grey / matt	matching hot-dip galvanizations	aluminium / metallic shine
Binding agents:	epoxy resin ester	alkyd resin	alkyd combination
Pigment:	zinc pigments (D50 4 µm)	zinc and aluminium pigments (D50 25 µm)	aluminium pigments (D50 16 µm)
Pigment purity:	approx. 98,5 %	approx. AL 99,5% and ZN 99,9%	approx. 99,5 %
Specific weight:	1,96 g/cm ³	1,25 g/cm ³	1,00 g/cm ³
Percentage of metal in the dry film:	approx. 60,5 %	approx. 58,5 %	approx. 32,0 %
Viscosity* (DIN EN ISO 2431) / Consistency:	approx. 70 s 4 mm / stretchable	approx. 70 s 4 mm / stretchable	approx. 120 s 4 mm / stretchable
Processing temperature:	+18°C to +30°C (+64°C to +86°F)	+18°C to +30°C (+64°C to +86°F)	+18°C to +30°C (+64°C to +86°F)
Consumption:	approx. 120 ml/m ²	approx. 120 ml/m ²	approx. 150 ml/m ²
Spray consistency:	10 - 20 % universal thinning	10 - 20 % universal thinning	10 - 20 % universal thinning
Drying time (dust dry):	30 minutes	60 minutes	60 minutes
Hardened*:	12 hours	12 hours	12 hours
Recoatible / can be reprimed*:	12 hours	12 hours	12 hours
Final hardness*:	48 hours	48 hours	48 hours
Minimum layer thickness:	50 µm	30 µm	20 µm
Cross-cut test (DIN 53151):	characteristic value GT 0 to GT 1	characteristic value GT 0 to GT 1	characteristic value GT 0 to GT 1
Salt spray test (DIN EN ISO 9227)	400 hours	200 hours	100 hours
Mandrel bending test, mandrel 5 mm (DIN EN ISO 1519):	no formation of hairline cracks	no formation of hairline cracks	no formation of hairline cracks
Temperature resistance after reaching the final hardness:	approx. +400°C (+752°F)	approx. +240°C (+464°F)	approx. +300°C (+572°F) (from +100°C (+212°F), slight discolourations are possible)
Primer:	not necessary	not necessary	WEICON Brushable Zinc Paint / Brushable Zinc Coating
Shelf life**:	12 - 18 months	12 - 18 months	12 - 18 months
Available in:	375 ml and 750 ml can	375 ml and 750 ml can	375 ml and 750 ml can
Classification in accordance with Directive 2004/42 EC category 'A/I' single component special paints:	< 500 g/l VOC	< 500 g/l VOC	< 500 g/l VOC

* +20°C (+68°F) can / surface temperature and 50% relative humidity.

** With a constant room temperature of +20°C (+68°F) and storage in a dry place. This applies to closed original containers which are not exposed to direct and/or indirect sunlight.

Technical Liquids

Technical Data

	Colour	Odour	Temperature resistance	Shelf life min. (months)*	Special features	Suitable for use with
Adhesive Spray Liquid	beige	solvent	---	12	versatile use	---
AT-44	yellowish	vanilla	-50°C (-58°F) to +210°C (+410°F)	24	high-performance lubricating oil - with PTFE	WSD 400 and WPS 1500
Bio-Cut	colourless	almost odourless	to +200°C (+392°F)	24	mineral oil-free, easily biodegradable	WSD 400
Bio-Fluid	colourless	almost odourless	-25°C (-13°F) to +120°C (+248°F)	24	meets requirements of DAB 10, USDA H1, FDA regulations, FDA positive list	---
Bio Welding Protection	milky	almost odourless	+5°C (+41°F) to +90°C (+194°F)	24	non-flammable, silicone-free	WSD 400 and WPS 1500
Brake Cleaner	colourless	citrus	---	24	evaporates without leaving residues	WSD 400, WPS 1500 and Pump Dispenser "special"
Corro-Protection	colourless	solvent	-20°C (-4°F) to +80°C (+176°F)	24	TÜV-tested, wax-based	WSD 400 and WPS 1500 (The material must be stirred thoroughly before use.)
Citrus Cleaner	colourless	citrus	---	24	pH-neutral, evaporates without leaving residues	WSD 400, WPS 1500 and Pump Dispenser "special"
Sealant and Adhesive Remover	pink	solvent	---	24	powerful	---
Stainless Steel Care	colourless	solvent	-20°C (-4°F) to +130°C (+266°F)	24	antistatic effect, especially for outdoor use	WSD 400 and WPS 1500
Electro Contact Cleaner	colourless	almost odourless	---	24	evaporates without residues	WSD 400 and WPS 1500
Label Remover	colourless	citrus	---	24	removes paper and foil labels	WSD 400 and WPS 1500
Mould Cleaner	colourless	citrus	---	24	evaporates without residues	WSD 400 and WPS 1500
Mould Release Agent	colourless	solvent	-20°C (-4°F) to +130°C (+266°F)	24	silicone-free	Pump Dispenser, WSD 400 and WPS 1500
Leak Detector	milky	almost odourless	0°C (+32°F) to +50°C (+122°F)	24	approved for gas piping by German DVGW, suitable for oxygen and CO ₂	WSD 400 and WPS 1500
Leak Detector frost-proof	colourless	almost odourless	-15°C (+5°F) to +40°C (+104°F)	24	DVGW approved, suitable for oxygen and CO ₂ , frost-proof	WSD 400 and WPS 1500
Leak Detector viscous	milky	almost odourless	0°C (+32°F) to +50°C (+122°F)	24	suitable for oxygen and CO ₂	WSD 400 and WPS 1500
Metal-Fluid	milky	almost odourless	-10°C (+14°F) to +150°C (+302°F)	24	antistatic effect, especially for indoor use	Pump Dispenser, WSD 400 and WPS 1500
Surface Cleaner	colourless	citrus	---	24	evaporates without residues	WSD 400 and WPS 1500
Plastic Cleaner	colourless	citrus	---	24	for sensitive plastic surfaces	WSD 400 and WPS 1500
Pneuma-Lube	yellowish	vanilla	-50°C (-58°F) to +210°C (+410°F)	24	high-performance lubricating oil - with PTFE	WSD 400 and WPS 1500
Cleaner S	colourless	orange	---	24	evaporates without residues	WSD 400, WPS 1500 and Pump Dispenser "special"
Cleaner M	colourless	almost odourless	---	24	classified as non-hazardous fast-drying non-flammable	WSD 400, WPS 1500 and Pump Dispenser
Rust Loosener	beige	petroleum	-20°C (-4°F) to +150°C (+302°F)	24	sixfold function	WSD 400, WPS 1500 and Pump Dispenser "special"
Rust Converter	milky	almost odourless	-30°C (-22°F) to +80°C (+176°F)	24	rust converter and base coat in one process	---
Fast Cleaner	colourless	solvent	-10°C to +50°C (+14°F to +122°F)	24	NSF-A1 approval	WSD 400 and WPS 1500
Silicone	colourless	solvent	-50°C (-58°F) to +250°C (+482°F)	24	silicone oil	WSD 400 and WPS 1500
Parts and Assembly Cleaner	colourless	solvent	---	24	high flash point (>+60°C/+140°F)	WSD 400 and WPS 1500
W 44 T®	yellowish	vanilla	-50°C (-58°F) to +210°C (+410°F)	24	multi-function oil - with multiple effects	Pump Dispenser, WSD 400 and WPS 1500
Workshop Cleaner	blue	almost odourless	+5°C (+41°F) to +90°C (+194°F)	24	solvent-free, oil removal accommodating, biodegradable	WPS 1500

* With a constant room temperature of +20°C (+68°F) and storage in a dry place. This applies to closed original containers which are not exposed to direct and/or indirect sunlight.

Product	Page
Anti-Seize	182
Anti-Seize High-Tech	182
Copper Paste	184
Anti-Seize Nickel	184



Anti-Seize High-Tech

Montage-Paste / Assembly Paste



NSF International
Commodity
Program - listed #11
Registration: SA1806



ASW 450 · Farbe/Colour: weiß/white
-40°C – +1.400°C (-40°F – +2.552°F)



Anti-Seize Montage-Paste

AS 450 · Farbe: anthrazit · -180°C bis +1.200°C



Anti-Seize Assembly Paste

AS 450 · Colour: anthracite · -292°F to +2.192°F

www.weicon.com

All kinds of influencing factors, such as moisture and friction, lead to damage due to corrosion, seizure, and wear on machines and installations. Extensive repair and maintenance work at considerable cost are the result.

Especially under critical conditions of application, such as:

- ▶ high operation temperatures
- ▶ high pressure loads
- ▶ outdoor weather conditions

WEICON Anti-Seize assembly pastes are specially developed for these requirements. They are used as protecting and separating agents as well as lubricants for highly stressed parts, especially at high temperatures.

Optimally balanced solids contents as well as selected additives permit a wide range of applications, especially in this area.

Conventional separating agents or lubricants such as mineral oils and greases often cannot provide sufficient lubrication and protection in difficult industrial environments.

Conventional separating agents or lubricants such as mineral oils and greases often cannot provide sufficient lubrication and protection in difficult industrial environments.

The basic components in WEICON Anti-Seize are made of synthetic oils, which have a considerably lower sulphur content than products containing mineral oil. A residue-free vaporisation of the oil at temperatures between +200°C (+392°F) and +250°C (+482°F) is thus possible.

This is particularly important in the case of stainless steels (e.g. for VA material) to prevent stress-corrosion cracking. The safe protection of work pieces and structures made of steel and other metals is thus absolutely necessary for the rational and economic operation of technical installations.

WEICON Middle East L.L.C.
Jebel Ali Ind Area 3
P.O. Box 118 216
Dubai
United Arab Emirates
Phone: + 971 488 025 05

WEICON SA (Pty) Ltd
Unit No. 01 - Enterprise Village
Capricorn Drive - Capricorn Park
Muizenberg 7945 - Cape Town
South Africa
Phone: + 27 (0) 217 090 088

WEICON GmbH & Co. KG
Königsberger Str. 255 - DE-48157 Münster
P.O. Box 84 60 - DE-48045 Münster
Tel. + 49 (0) 251 9322 0

WEICON SA (Pty) Ltd
Unit No. 01 - Enterprise Village
Capricorn Drive - Capricorn Park
Muizenberg 7945 - Cape Town
South Africa
Phone: + 27 (0) 217 090 088

Anti-Seize

Assembly Pastes

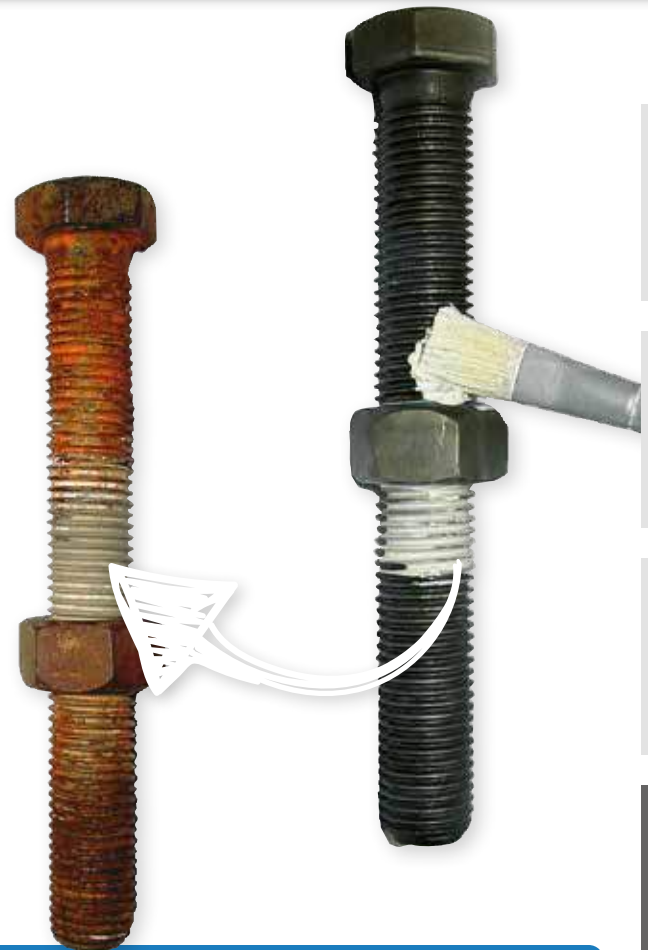

Due to the special formulation and the very fine grinding of the solids contained in WEICON Anti-Seize, irregularities in the protected surface are completely filled – even to a layer thickness of only 12 µm. Only a perfectly sealed surface guarantees a reliable protection against corrosion. An additional sealing effect thus results for special applications, such as flange connections.

WEICON Anti-Seize provides protection against the following:

- ▶ corrosion – seizure – wear
- ▶ stick-slip phenomena
- ▶ oxidation and fretting corrosion
- ▶ electrolytic reactions (“cold welding”)

WEICON Anti-Seize is free of halogens, well-adherent and abrasion-proof, and resistant against hot, cold, and salt water. The extremely low friction coefficient also permits easy disassembly from machines and installations.

In addition, WEICON Anti-Seize assembly pastes are excellent lubricants for statically high-stressed parts and for slowly rotating installations, as long as corresponding relubrication intervals are observed.

With its dual function as a lubricant and corrosion protection agent, WEICON Anti-Seize thus becomes a rationalisation factor, both in terms of saving time and reducing costs.

WEICON Anti-Seize is used sparingly. At a layer thickness of 0,01 mm, 1 kg suffices to cover a surface area of approximately 45 m². Four product variants are available for various areas of application:

Anti-Seize
Anti-Seize High-Tech
Copper Paste
Anti-Seize Nickel

Adhesives / Sealants

Technical Sprays

Technical Liquids

Assembly Pastes

Lubricants

WEICON TOOLS®

Other



Anti-Seize

Reliable protection against corrosion, seizing and cold welding

WEICON Anti-Seize is used as a protecting, separating and lubricating agent for highly stressed parts. Ideally compatible solid contents and selected additives enable a wide range of usage.

Anti-Seize protects against corrosion, seizure and wear, stick-slip phenomena, oxidation, fretting corrosion and electrolytic reactions ("cold welding").

Anti-Seize High-Tech



Metal-free

Anti Seize "High-Tech" is high-temperature-resistant, has excellent separating characteristics, is metal-free, neutral to materials and has an NSF registration.

Anti-Seize "High-Tech" is particularly suitable when metal-containing pastes can cause electrolytic reactions, when nickel-containing products should or may not be used due to health reasons and when dark metal-containing products should or may not be used for visual reasons.

Anti-Seize

Assembly Pastes



	Anti-Seize	Anti-Seize High Tech
▶ 10 g Syringe	26000001	-
▶ 30 g Pen	26000003	26100003
▶ 120 g Brush top can	26000012	26100012
▶ 85 g Tube	26000085	26100085
▶ 200 ml Presspack	26000200	-
▶ 400 g Cartridge	26000040	26100040
▶ 450 g Can	26000045	26100045
▶ 500 g Brush top can	26000050	26100050
▶ 1,0 kg Can	26000100	26100100
▶ 1,8 kg Bucket	26000180	26100180
▶ 5,0 kg Bucket	26000500	26100500
▶ 10,0 kg Bucket	26000910	26100910
▶ 20,0 kg Bucket	26000920	26100920
▶ 100 ml Spray	27000100	-
▶ 400 ml Spray	27000400	27050400





Copper Paste

Protecting, separating and lubricating agent for highly stressed parts in high-temperature applications

Copper Paste is corrosion-resistant and strong. It contains no sulphur, lead or nickel.

WEICON Copper Paste is used as an assembly lubricant for all kinds of threaded joints and sliding surfaces. It forms an effective lubricating and separating film which protects the functional surfaces on plug-in tools, wear bushings, screws, and all kinds of threaded, plug-in and bayonet joints against corrosion and seizing.

It can be used to reduce vibration on brake blocks and guides, brake cams and pins, car and truck battery terminals and other electrical connections, wheel bolts and nuts, and on wear bushings at electrical, compressed air and hydraulic hammers. The product can be used in many industrial applications.



Anti-Seize Nickel

Assembly paste for extreme conditions

The assembly paste was developed to resist extreme conditions. It is strongly adherent, water-repellent and resistant to sweet, salt and hot water as well as steam. The high nickel component furthermore provides protection against corroding and corrosive solvents which are contained in diluted hydrochloric acid, sulphur or nitric acid, among others. Anti-Seize Nickel can be applied at a large temperature range between -30°C to +1.450°C.

Anti-Seize Nickel serves as corrosion protection and highperformance fitting grease for static and dynamically extremely stressed screw connections and installation parts and the application at slowly rotating system in the high-temperature range.

The paste protects against corrosion, seizing, wear, stick-slip effects, oxidation and friction corrosion as well as electrolytic reactions, the so-called "cold welding".

For example, Anti-Seize Nickel can be used on seals, valves, screw connections, gear wheels, bearings, jets, conveyor belts, studs, tools or cylinders.

	Copper Paste	Anti-Seize Nickel
▶ 30 g Pen	26200003	-
▶ 120 g Brush top can	26200012	26050012
▶ 85 g Tube	26200085	-
▶ 200 ml Presspack	26200200	-
▶ 400 g Cartridge	26200040	26050040
▶ 450 g Can	26200045	26050045
▶ 500 g Brush top can	26200050	26050050
▶ 1,0 kg Can	26200100	26050100
▶ 1,8 kg Bucket	-	26050180
▶ 5,0 kg Bucket	-	26050500
▶ 10,0 kg Bucket	26200910	26050910
▶ 20,0 kg Bucket	-	26050920
▶ 400 ml Spray	27200400	-

Assembly Pastes

WEICON Anti-Seize products and their behaviour towards sealing materials (elastomers)

	Anti-Seize	Anti-Seize High-Tech	Copper Paste	Anti-Seize Nickel
ACM - Acrylate rubber	++	++	++	++
CR - Chloroprene rubber	+	+	+	+
CSM - Chlorosulfonated PE rubber	+	+	+	+
EPDM - Ethylene propylene diene rubber	--	--	--	--
FKM - Fluorocacoutchoc	++	++	++	++
NBR - Nitrile butadiene rubber	++	++	++	++
NR - Natural rubber	--	--	--	--
SBR - Styrene butadiene rubber	--	--	--	--
SQM/VMQ - Silicone rubber	++	++	++	++

WEICON Anti-Seize products and their behaviour towards polymer materials

	Anti-Seize	Anti-Seize High-Tech	Copper Paste	Anti-Seize Nickel
ABS - ABS copolymeride	++	++	++	++
PA - Polyamide	++	++	++	++
PC - Polycarbonate	--	--	--	--
PE-UHMW - Polyethylene with ultra high molar weight	++	++	++	++
PE-LD - Polyethylene with low density	+	+	+	+
PET - Polyethyleneterephthalate	++	++	++	++
POM - Polyoxymethylene	++	++	++	++
PP - Polypropylene	++	++	++	++
PTFE - Polytetrafluor ethylene	++	++	++	++
PUR - Polyurethane	+	+	+	+
PVC - Polyvinylchloride	++	++	++	++

++ resistant + resistant to a limited extent -- not resistant

The specified resistance levels are based on laboratory tests and literature notices. A guarantee cannot be provided due to the large number of raw materials used on the one hand and the complex chemical and morphological structure of the polymers on the other. In critical application cases, we recommend that you carry out tests and/or consult with our application technology department.

Technical Data

	Anti-Seize	Anti-Seize High-Tech	Anti-Seize Nickel	Copper Paste
Basic oil	synthetic oil mixture	medicinal oil	synthetic oil	mineral oil
Colour	anthracite	white	anthracite	copper
OFW device coefficient of friction	0,13	0,10 to 0,13	0,16	---
Coefficient of friction total	0,14 µ	0,13 µ	0,15 µ	0,12 µ
Coefficient of friction thread	0,13 µ	0,11 µ	0,14 µ	0,11 µ
Coefficient of friction on upside down	0,15 µ	0,14 µ	0,16 µ	0,13 µ
VKA-TEST (DIN 51350) goods load	4.200 N	3.600 N	---	3.000 N
VKA-TEST (DIN 51350) welding load	4.400 N	3.800 N	2.000 N	3.200 N
VKA-TEST (DIN 51350) Spherical cap value (1 Min/1000N)	0,5 mm	0,7 mm	0,6 mm	---
Worked penetration (DIN ISO 2137)	310 to 340 1/10 mm	310 to 340 1/10 mm	310 to 340	310 to 340 1/10 mm
Sulphur content (DIN 51400)	< 0,1%	< 0,1%	< 0,1%	< 0,1%
Water resistance (DIN 51807)	0 - 90	0 - 91	0 - 91	0 - 91
Temperature resistance	-180 to +1.200°C (-292 to +2.192°F)	-40 to +1.400°C (-40 to +2.552°F)	-30 to +1.450°C (-22 to +2642°F)	-20 to 1.100°C (-4 to +2012°F)
Pressure load	230 N/mm² (33.400 psi)	230 N/mm² (33.400 psi)	230 N/mm² (33.400 psi)	---
Density at +20°C (+68°F) (DIN 51757)	1,16 g/cm³	1,42 g/cm³	1,30 g/cm³	1,1 g/cm³
Salt spray test	> 170 h	> 170 h	> 170 h	---
Thermal conductivity	0,3 W/m-K	0,7 W/m-K	---	---
Dielectric strength	0,47 kV/mm	0,40 kV/mm	---	---
Specific resistance	1,2 x 10 ¹⁵ Ohm/cm	1,0 x 10 ¹⁵ Ohm/cm	---	---
Specific heat capacity	1,325 J/(g-K)	1,574 J/(g-K)	1,493 J/(g-K)	1,713 J/(g-K)
Thermal conductivity (ISO 22007-4)	+20°C (+68°F) 0,546 W/(m-K)	0,675 W/(m-K)	0,582 W/(m-K)	0,392 W/(m-K)
Dielectric strength (DIN EN 60243-1)	1,3 kV/mm	6,3 kV/mm	1,1 kV/mm	1,7 kV/mm

High Performance Greases

Product	Page
AL-F	188
AL-H	188
AL-T	188
AL-W	189
AL-M	189
Silicone Grease	189



Provide sustained protection against friction and wear

- ▶ extremely long re-greasing intervals
- ▶ increased functional dependability and the retention of the value of the machine and production plants
- ▶ reduction of the maintenance and repair work
- ▶ improved economic efficiency

High Performance Greases

Allround Lubricant



Adhesives / Sealants

Technical Sprays

Technical Liquids

Assembly Pastes

Lubricants

WEICON TOOLS®

Other



AL-F

NSF
Noricomp Compounds
Program Listed #2
Registration 136173
NO FOOD CONTACT

Allround product

WEICON AL-F can be used to lubricate rolling and sliding bearings, joints, levers, sliding guides, spindles, spline shafts, camshafts, open gears, worm gears and all grease lubrication points, even in the food industry.

- ▶ 350 g ▶ 400 g ▶ 1,0 kg
- 26550035 26550040 26550100
- ▶ 5,0 kg ▶ 25,0 kg
- 26550500 26550925



AL-H

NSF
Noricomp Compounds
Program Listed #3
Registration 136174

High-temperature-resistant | odourless and tasteless

WEICON AL-H is suitable for rolling bearings, sliding bearings, joints, spindles, spline shafts and linear guidance systems at all sliding speeds permitted for grease lubrication.

WEICON AL-H is particularly suited for usage in foodstuff technology.

- ▶ 400 g ▶ 1,0 kg ▶ 5,0 kg
- 26500040 26500100 26500500
- ▶ 25,0 kg
- 26500925

AL-T

High-temperature grease | long-term lubrication

WEICON AL-T high performance grease is a universally usable high-temperature grease for long-term lubrication. WEICON AL-T is suitable for rolling and sliding bearings, joints, levers, sliding guides, spindles, spline shafts and at all sliding speeds permitted for grease lubrication.

- ▶ 400 g ▶ 1,0 kg ▶ 5,0 kg
- 26600040 26600100 26600500
- ▶ 25,0 kg
- 26600925



High Performance Greases

Allround Lubricant

AL-M

Long-term lubricant with MoS₂ | strong adhesion and high pressure resistance

WEICON AL-M reduces friction and wear for a long time and is suited for rolling and slide bearings, joints, levers, sliding guides, spindles, camshafts, spline shafts, springs, open gears, worm gears and at all sliding speeds permitted for grease lubrication.

- ▶ 400 g ▶ 1,0 kg ▶ 5,0 kg
- 26400040 26400100 26400500
- ▶ 25,0 kg
- 26400925

AL-W

Special lubricant for underwater applications

AL-W high performance grease is a special lubricant and corrosion protection which can also be used for underwater applications.

WEICON AL-W offers effective protection against aggressive liquids such as sea or wastewater, both in the maritime sector and in wet plants. WEICON AL-W is suitable for rolling and sliding bearings even in mixed friction operation, for joints, levers, sliding guides, spindles, spline shafts, open gears, worm gears, chains and wire cables and at all sliding speeds permitted for grease lubrication.

- ▶ 400 g ▶ 1,0 kg ▶ 5,0 kg
- 26450040 26450100 26450500
- ▶ 25,0 kg
- 26450925



Silicone Grease



Special lubricant for valves, fittings and sealings | drinking water approval* | BAM**

Strong and transparent silicone grease with a very good compatibility to plastics, especially for applications on valves, fittings and sealings.

Due to its NSF H1 registration, WEICON Silicone Grease is suitable as lubricant in sensitive areas where inadvertent contact to food is possible. It can be used in the food and beverage industry, in sanitary and heating construction, in the pharmaceutical industry as well as in the sealing technology.

- ▶ 5 g ▶ 85 g ▶ 450 g
- 26350005 26350085 26350045
- ▶ 1,0 kg ▶ 5,0 kg ▶ 25,0 kg
- 26350100 26350500 26350925

The grease is particularly material-friendly, neutral in odour and taste and has a temperature resistance of -50°C to +200°C.

WEICON Silicone Grease is suitable for the lubrication of plastics, rubber parts and seals, valves, fittings and gaskets, machines, equipment, slow rotating bearings and as assembly aid for O-rings.

*Tested by the Ruhr Region Institute of Hygiene („Hygiene- Institut des Ruhrgebiets“) according to the Hygienic Assessment of Lubricants in Contact with Drinking Water by the Federal Environmental Agency of Germany.

**BAM tested and safety-related evaluated according to leaflet M 031-1 „List of nonmetallic materials compatible with oxygen“ (DGUV information 213-078) of BG RCI





Technical Data

		AL-T	AL-M	AL-W	AL-H	AL-F	Silicone Grease
Abbreviation (DIN 51502):		KPL 2 R -20	KF 2 K -20	KPL 1-2 E -25	KPHC 1P -40	KLF 2K -30	---
Consistency assignment (DIN 51818):		NLGI-class 2	NLGI-class 2	NLGI-class 1-2	NLGI-class 1	NLGI-class 2	NLGI-class 2-3
Basis:		Aluminium complex soap / mineral oil	Li/Ca soap / MoS ₂ / mineral oil	Spec. calcium soap / mineral oil	Aluminium complex soap / polyalphaolefine	Lithium soap / mineral oil	Pyrogenic silica silicone oil
Colour:		darkbrown	black	beige	yellowish-white	white	colourless translucent
VKA Test (DIN 51 350):	welding load	2400 N	3200 N	3400 N	1800 N	3600 N	---
	goods load	2200 N	3000 N	3200 N	1700 N	3400 N	---
	Spherical cap value (1 Min / 1000 N)	2,0 mm	0,5 mm	0,7 mm	0,6 mm	0,8 mm	---
Speed identifying value ($k_a \cdot n \cdot d_m$):		200 000	400 000	450 000	400 000	350 000	---
Worked penetration (DIN ISO 2137):		265-295 1/10 mm	265-295 1/10 mm	285-315 1/10 mm	310-340 1/10 mm	280 ± 15 1/10 mm	222-310 1/10 mm
Water resistance (DIN 51807):		0 - 90	1 - 90	0 - 40	1 - 90	1 - 90	0 - 90
Temperature resistance:		-25°C to +190°C (-13 to +374°F)	-20°C to +120°C (-4 to +248°F)	-25°C to +80°C (-13 to +176°F)	-40°C to +160°C (-40 to +320°F)	-30°C to +120°C (-22 to +248°F)	-50°C to +200°C (-58 to +392°F)
Drop point (IP 396):		>210°C (+410°F)	>170°C (+338°F)	>100°C (+212°F)	>200°C (+392°F)	>190°C (+374°F)	without
Base oil viscosity (DIN 51 562):	+40°C (+104°F)	approx. 230 mm ² /s	approx. 160 mm ² /s	approx. 100 mm ² /s	approx. 400 mm ² /s	approx. 100 mm ² /s	---
	+100°C (+212°F)	approx. 15 mm ² /s	approx. 15 mm ² /s	approx. 9 mm ² /s	approx. 40 mm ² /s	approx. 9 mm ² /s	---
Salt spray test with separated protective coats (Federal German Armed Forces Regulations 336 h/35°C, 5% NaCl):		---	---	no corrosion	---	---	---
EMCOR-corrosion test (DIN 51 802):		0 / 0	0 / 0	0 / 0	1 / 1	0 / 0	1 / 2
Density at +20°C (+68°F) (DIN 51757):		0,94 g/cm ³	0,92 g/cm ³	0,94 g/cm ³	0,93 g/cm ³	0,90 g/cm ³	0,98 g/cm ³
Conforms to:		. / .	. / .	Federal German Armed Forces TL 9150-0066, NATO specification G-460	NSF-H 1	NSF-H 2	NSF-H 1
Specific heat capacity	+20°C (+68°F)	1,490 J/(g*K)	1,766 J/(g*K)	1,762 J/(g*K)	1,838 J/(g*K)	1,832 J/(g*K)	1,295 J/(g*K)
Thermal conductivity (ISO 22007-4)		0,372 W/(m*K)	0,491 W/(m*K)	0,494 W/(m*K)	0,394 W/(m*K)	0,524 W/(m*K)	0,445 W/(m*K)
Dielectric strength (DIN EN 60243-1)		11,0 kV/mm	11,5 kV/mm	9,5 kV/mm	29,6 kV/mm	7,8 kV/mm	9,2 kV/mm
Shelf life at least (months)*:		24	24	24	24	24	24

Type selection table

	AL-T	AL-M	AL-W	AL-H	AL-F	Silicone Grease
Rolling bearings	•	•	•	•	•	
Sliding bearings	•	•	•	•	•	
Chains			•			
Joints	•	•	•	•	•	•
Lever	•	•	•	•	•	•
Sliding guides	•	•	•	•	•	•
Linear guide systems	•			•		•
Spindles	•	•	•	•	•	•
Spline shafts	•	•	•		•	
Camshafts		•			•	
Springs		•				
Open gears		•	•		•	
Worm gears		•	•		•	
Cables			•			

High Performance Greases

Allround Lubricant

WEICON lubricants and their behaviour towards sealing materials (elastomers)

	AL-T	AL-M	AL-W	AL-H	AL-F	Silicone Grease
ACM - Acrylate rubber	++	++	++	++	++	++
CR - Chloroprene rubber	+	+	+	+	+	++
CSM - Chlorosulfonated PE rubber	++	++	++	++	++	++
EPDM - Ethylene propylene diene rubber	--	--	--	--	--	++
FKM - Fluorocautchoc	++	++	++	++	++	++
NBR - Nitrile butadiene rubber	++	++	++	++	++	++
NR - Natural rubber	0	--	--	--	--	++
SBR - Styrene butadiene rubber	0	--	--	--	--	++
SQM/MVQ - Silicone rubber	++	++	++	++	++	++

++ resistant + resistant to a limited extent 0 not tested, preliminary trials or resistance tests are recommended – not resistant

WEICON lubricants and their behaviour towards polymer materials

	AL-T	AL-M	AL-W	AL-H	AL-F	Silicone Grease
ABS - ABS copolymeride	++	++	++	++	++	++
CA - Cellulose acetate	++	++	++	++	++	++
EPS - Expanded polystyrene	++	++	++	++	++	++
PA - Polyamide	++	++	++	++	++	++
PC - Polycarbonate	--	--	--	+	--	++
PE - Polyethylene	++	++	++	++	++	++
PE-UHMW - Polyethylene with ultra high molar mass	++	++	++	++	++	++
PE-LD - Polyethylene with low density	+	+	+	++	+	++
PET - Polyethyleneterephthalate	++	++	++	++	++	++
POM - Polyoxymethylene	++	++	++	++	++	++
PP - Polypropylene	++	++	++	++	++	++
Polyphenylene oxide	++	++	++	++	++	++
PS - Polystyrene	+	+	+	++	+	++
PTFE - Polytetrafluor ethylene	++	++	++	++	++	++
PUR - Polyurethane	+	+	+	++	+	++
PVC - Polyvinylchloride	++	++	++	++	++	++
TPE - Thermoplastic elastomers	0	0	0	0	0	++

++ resistant + resistant to a limited extent 0 not tested, preliminary trials or resistance tests are recommended – not resistant

The stated resistance levels are based on laboratory tests and literature notices. A guarantee cannot be provided due to the large number of raw materials used on the one hand and the complex chemical and morphological structure of the polymers on the other. In critical application cases we recommend that you carry out tests and/or consult with our application technology department.



Adhesives / Sealants

Technical Sprays

Technical Liquids

Assembly Pastes

Lubricants

WEICON TOOLS®

Other

Cable Strippers

Product	Page
No. S 4 - 28	196
No. S 4 - 28 Multi	196
No. 4 - 16	197
No. 8 - 27	197
No. 4 - 28 H	197
No. 4 - 28 G	197
No. 28 - 35	197
No. 35 - 50	197
No. C 4 - 16	197
No. C 8 - 27	197
No. C 4 - 28	197

Wire Strippers

No. 5	198
No. 5 Classic	199
No. 6	199
No. 7 Magic	200
No. 7-F	200
Precision Wire Stripper S	201
ESD Precision Wire Stripper	201
Fibre Optic Stripper	201

Stripping Tools

Coax-Stripper No. 1 F Plus	202
Coax-Stripper No. 2	203
Stripper No. 2 Cat	203
Combi-Coax No. 3	203
Round Cable Stripper No. 13	204
Round Cable Stripper No. 13 Classic	204
Cat Cable-Stripper No. 10	204
Quadro-Stripper No. 16	205

Multi-Purpose Strippers

Product	Page
Duo-Crimp No. 300	206
Stripper No. 100	207
Data-Strip No. 30	207
Mini-Duo No. 150	208
Duo-Stripper No. 200	208
Multi-Stripper No. 400	209

Special Tools

Mini Solar No. 3	210
Wire Stripper No. 7 Solar	210
LSA Sensor No. 40	211
Cable Scissors No. 35	211
Dismantling Tool No. 25	212
Cable Stripper H.D. No. 1000	212
Cable Stripper No. 4 - 29 Spiral	212
Multi-Opener	213
Easy Opener®	213

Tool Sets

Crimp-Set Pro	214
Starter-Set Pro	214
Electrical Installation Set 1-4	215

WEICON TOOLS®

Stripping Tools

Best Of 2022

**Heimwerker
Praxis** 1/22

Weicon Präzisions-Abisolierer S
Kategorie: Handwerkzeuge



reddot winner 2020



WEICON TOOLS®

Since 1967, we have been developing, producing and distributing a broad range of wire stripping tools. This includes cable knives, wire strippers, dismantling, multi-functional and special tools. Our tools have been developed for accurate, fast and safe stripping of all common cable types. They carry the GS seal of TÜV Nord and were developed with regard to work safety aspects.

The tools are specifically tailored to the needs of professional users, are found in both, skilled trades and industrial use, and are also suitable for domestic use.

Quality and continuity "made in germany"
INNOVATIVE AND RELIABLE!



Member of the German Tool Industry Association



Adhesives / Sealants
Technical Sprays
Technical Liquids
Assembly Pastes
Lubricants
WEICON TOOLS®
Other

We produce
SUSTAINABLY!

Have a look at our
WEICON-TOOLS®



Since the beginning of 2020, we have been packaging our WEICON TOOLS products in recyclable cardboard boxes.

These will come in three different sizes in the future to protect all tools produced by our Muenster-based family business.



Adhesives / Sealants

Technical Sprays

Technical Liquids

Assembly Pastes

Lubricants

WEICON TOOLS®

Other

Have a look at our
WEICON-TOOLS®



CABLE STRIPPERS

- ▶ completely ergonomic & fully insulated
- ▶ continuous regulation and easy to operate adjusting wheel
- ▶ precise, quick and safe stripping



No. S 4 - 28

Safe due to retractable hook blade
▶ the blade can be locked in both positions

mm	g	mm ²	Ømm	Art.-No.
145	72	-	4 - 28	50055328



No. S 4 - 28 Multi

Stripping function integrated in the housing
▶ stripping of all standard flexible and solid cables with a cross-diameter between 0,5 and 6 mm²

mm	g	mm ²	Ømm	Art.-No.
145	61	0,5 - 6 (20 - 10 AWG)	4 - 28	50057328



Adhesives / Sealants

Technical Sprays

Technical Liquids

Assembly Pastes

Lubricants

WEICON TOOLS®

Other



Cable Strippers

	↔ mm	📖 g	Ømm	Art.-No.
No. 4 - 16	140	84	4 - 16	50050116
No. 8 - 27	140	92	8 - 28	50050227
No. 4 - 28 H	185	98	4 - 28 with hook blade	50054328
No. 4 - 28 G	195	104	4 - 28 with straight blade	50054428
No. 28 - 35	170	87	28 - 35	50050435
No. 35 - 50	180	90	35 - 50	50050450

Classic-Version

	↔ mm	📖 g	Ømm	Art.-No.
No. C 4 - 16	135	67	4 - 16	50053116
No. C 8 - 27	135	69	8 - 28	50053227
No. C 4 - 28	180	80	4 - 28 with hook blade	50053328



Adhesives / Sealants

Technical Sprays

Technical Liquids

Assembly Pastes

Lubricants

WEICON TOOLS®

Other

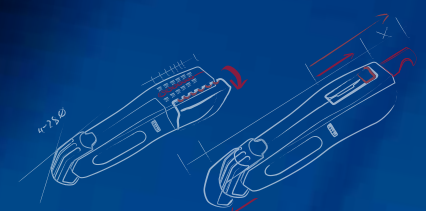



WIRE STRIPPERS

Automatic wire strippers for all common stranded and solid conductors. A scanning system adjusts automatically to the respective wire diameter, and thus permits fast and simple dismantling and stripping.



**Our
Bestseller**

No. 5

Saves space by locking the wire stripper

- ▶ automatic wire stripper
- ▶ precise work with adjustable length stop (5 - 12 mm)
- ▶ integrated, well accessible side cutter up to 2 mm Ø

mm	g	mm ²	Ømm	Art.-No.
170	107	0,2 - 6 (24 - 10 AWG)		51000005

selbst
ist der Mann
Das Do-it-yourself-Magazin

PRAXISTEST
- Kategorie: Ader-Abisolier-Werkzeuge -
SEHR GUT (1,3)
2 Produkte mit SEHR GUT

TESTSIEGER

Ausgabe 04/2018
11 Produkte im Test

www.selbst.de





No. 5 Classic

mm	g	mm ²	Ømm	Art.-No.
170	107	0,2 - 6 (24 - 10 AWG)		51003005



No. 6

Working under voltage up to 1000 Volt*
Unit testing according to DIN EN 60900

- ▶ fully insulated, automatic Wire Stripper
- ▶ precise work with adjustable length stop (5 - 12 mm)
- ▶ saves space by locking the strippers

mm	g	mm ²	Ømm	Art.-No.
170	105	0,2 - 6 (24 - 10 AWG)	-	51000006

* Tools with safety insulation are basic prerequisites for working on live wires. Please always pay attention to the legal regulations and follow the corresponding safety advice!



1000 V
IEC: 60900



WIRE STRIPPERS



No. 7 Magic

The all-rounder for stripping and dismantling
Pat.no. EP 1 671 407 B1

- ▶ for many different cable types in building installation
- ▶ precise work with optical length scale
- ▶ integrated, well accessible side cutter up to 3 mm Ø

mm	g	Round cables	mm ²	Art.-No.
170	217	Flexible	0,5 - 16 (20 - 6 AWG)	51000007
		Solid	0,5 - 10 (20 - 8 AWG)	

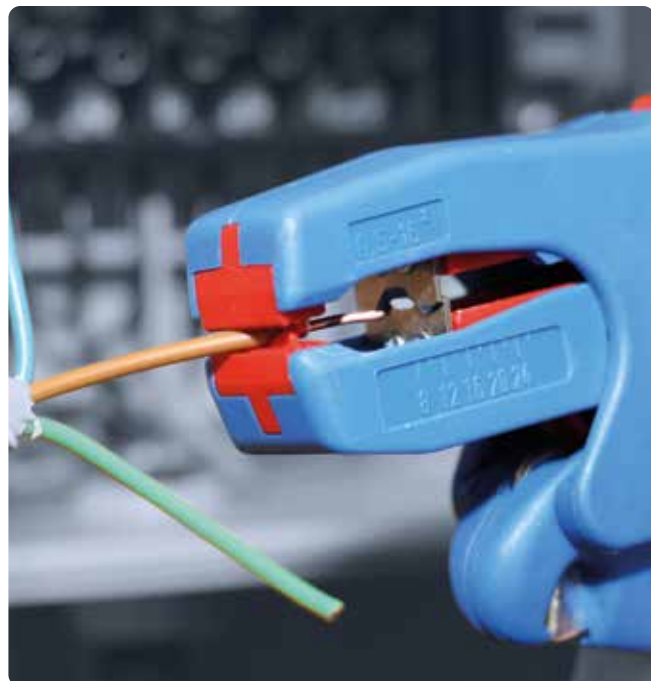

No. 7-F

Stripping and dismantling of all standard flat cables
Pat.no. EP 1 671 407 B1

- ▶ precise work with optical length scale
- ▶ integrated, well accessible side cutter up to 3 mm Ø

mm	g		mm ²	Art.-No.
170	220	Flat cables	0,75 - 4 (18 - 11 AWG)	51001007

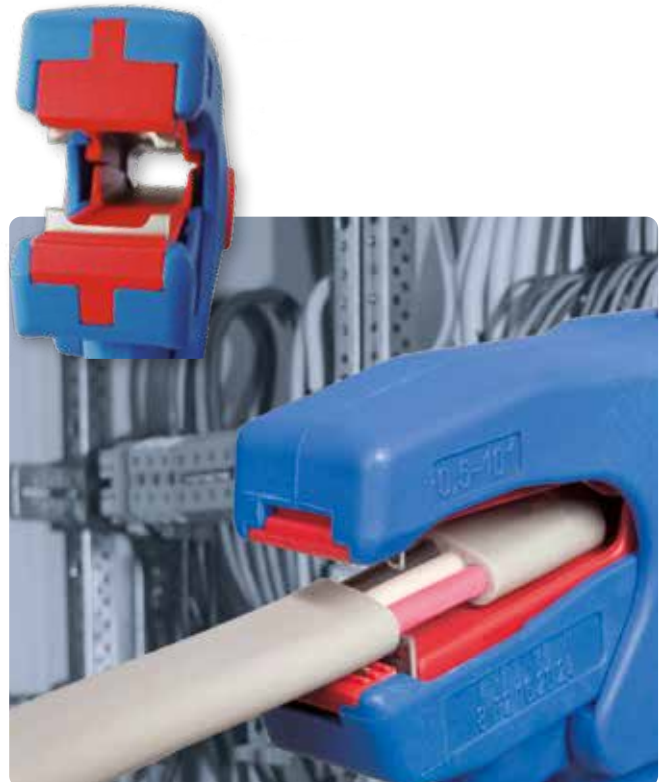



reddot winner 2020



DBGM 20 2019 107 281.4

Precision Wire Stripper S

Fast, easy and precise stripping of thin wires and conductors

Semi-automatic wire stripper for the fast and safe stripping of very fine conductors, strands or wires with small diameters in the range of 0,12 - 0,8 mm Ø (36 - 20 AWG). With the adjustable scaled length stop for the working range from 5 to 45 millimetres, the desired stripping length can be set quickly and reliably.

mm	g		Ø	Art.-No.
112	45	flexible solid	0,12 mm - 0,8 mm	51000002
112	45	flexible solid	0,12 mm - 0,8 mm	51001002



ESD Precision Wire Stripper

51001002



* ESD = dissipative ESD material protects against electrostatic discharge

Fibre Optic Stripper

51002002

mm	g	Cable type	Ø	Art.-No.
112	45	fibre optic Ø 0,125 mm	primary coating Ø 0,200 - 0,250 mm	51002002

fast and easy stripping of fibre optic primary coatings 200 - 250 µm

- ▶ for removing the primary coating on fibre optic cables Ø 0,125 mm
- ▶ blade Ø 0,16 mm, opening for cable insertion Ø 0,35 mm
- ▶ precise working thanks to adjustable length stop from 5 - 45 mm
- ▶ professional cable stripping technology
- ▶ suitable for right- and left-handed users



LWL primary coating
Ø 0,200 - 0,250 mm
(200-250 µm)

fibre optic
Ø 0,125 mm (125 µm)

STRIPPING TOOLS

Our stripping tools allow a range of different cables to be safely and conveniently stripped. The flexible tools can even be reliably used in hard-to-reach areas and always provide precise results.

Coax-Stripper No. 1 F Plus

Quick dismantling and stripping of coaxial cables with only one working step

- ▶ space-saving assembly and disassembly of F-connectors due to integrated open hexagon wrench with 11 mm width across flats
- ▶ gripping jaws for screwing F-connectors onto the cable
- ▶ changeable module inserts via click system



DBGM 20 2017 107 094



mm	g		Ømm	Art.-No.
125	47	Yellow	6,0 - 8,0	52001001
125	47	Red	6,0 - 8,0	52000001
125	47	Grey	4,0 - 5,0	52002001

*for mini coaxial cables

For further information and illustrations, take a look at page 216 with our spare parts!

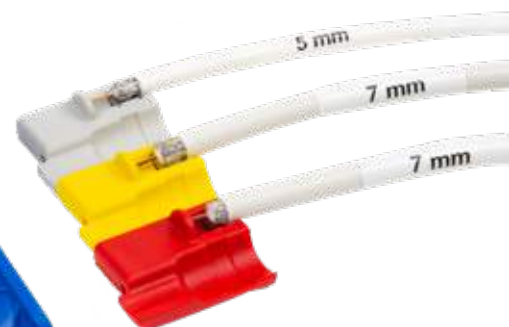
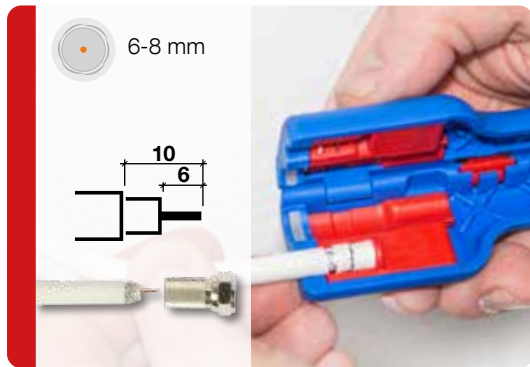

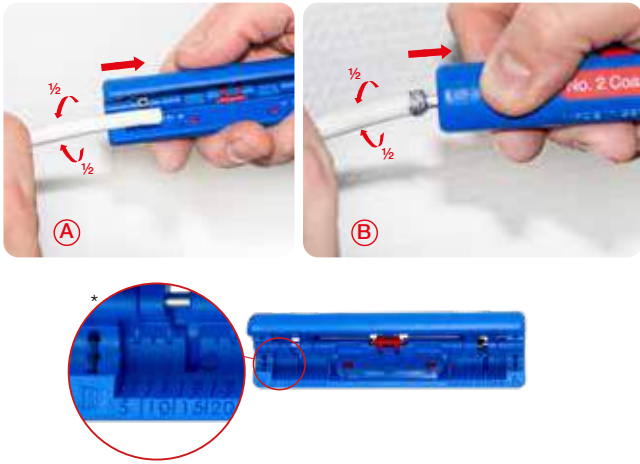

Coax-Stripper No. 2

Good handling due to ergonomic design

- ▶ two-level stripping of all common coaxial cables
- ▶ there is no need to adjust the cutting depth
- ▶ also suitable for flexible cables
- ▶ length scale (0 - 17 mm) integrated in the housing

mm	g	mm ²	Ømm	Art.-No.
110	28	-	4,8 - 7,5	52000002



Combi-Coax No. 3

Parallel blade arrangement allows even faster stripping

- ▶ allows two- or three-level stripping of all common coaxial cables
- ▶ also suitable for flexible cables
- ▶ integrated and well accessible side cutter up to 8 mm Ø

mm	g	mm ²	Ømm	Art.-No.
125	55	-	4,8 - 7,5	52000003

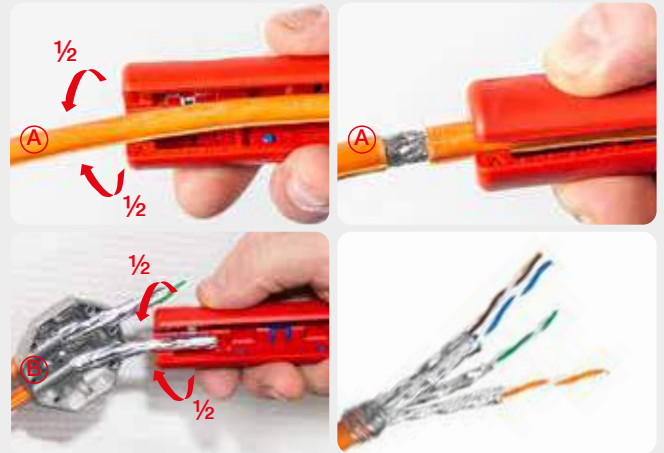

Stripper No. 2 Cat

Easy handling thanks to ergonomic shape

- ▶ for insulated PVC data cables (e.g. Cat5, Cat6, Cat7, twisted-pair cables) with a diameter of 4,5 -10 mm
- ▶ adjusting the cutting depth manually is not necessary
- ▶ the precise adjustment of the blade removes the outer jacket accurately. With the second blade, the foil shield is slit open carefully and can then be easily removed

mm	g	mm ²	Ømm	Art.-No.
110	28	-	4,5 - 10	52002002



STRIPPING TOOLS

Round Cable Stripper No. 13

Safe work with the ergonomic
anti-slip handle shape

- ▶ for all standard round cables
- ▶ flush stripping, even in hard-to-reach areas
- ▶ it is not necessary to adjust the cutting depth

mm	g	mm ²	Ømm	Art.-No.
140	48	-	6 - 13	52000013

Now with
length stop

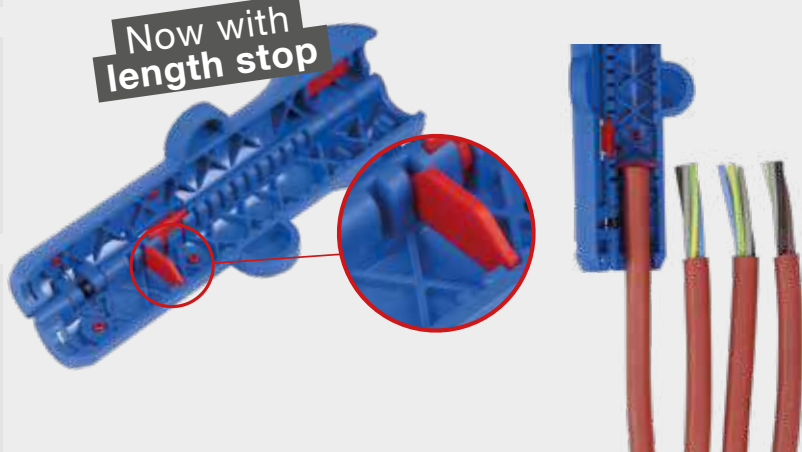

Round Cable Stripper No. 13 Classic

Safe work with the ergonomic
anti-slip handle shape

- ▶ for all standard round cables
- ▶ flush stripping, even in hard-to-reach areas
- ▶ it is not necessary to adjust the cutting depth

mm	g	mm ²	Ømm	Art.-No.
120	44	-	8 - 13	52003013



Cat Cable-Stripper No. 10

Easy and space-saving stripping of
data and network cables

- ▶ suitable for e.g. Cat5, Cat6, Cat7 twisted-pair cables (4,5 - 10mm Ø)
- ▶ integrated length stop, adjustable to the required length
- ▶ safe work with the ergonomic anti-slip handle shape

mm	g	mm ²	Ømm	Art.-No.
140	48	-	4,5 - 10	52000010



Quadro-Stripper No. 16

Multifunctional with optimized cable routing

- ▶ circular and longitudinal cutting - stripping - cutting
- ▶ exchangeable hook blade, firmly locked in any position
- ▶ anti-slip handle shape

mm	g	mm ²	Ømm	Art.-No.
125	53	0,5 - 6 (20 - 10 AWG)	8 - 13	52000016



Adhesives / Sealants

Technical Sprays

Technical Liquids

Assembly Pastes

Lubricants

WEICON TOOLS®

Other



"No. 16, 13 and 10 are particularly easy to handle thanks to their design. The ergonomic design ensures a safe gripping of the tool, so you won't slip off.

This makes daily work easier and also increases work safety."

Stephan Krampe, Managing Director
Krampe GmbH & Co.KG



MULTI-PURPOSE STRIPPERS

WEICON TOOLS multi-purpose strippers provide various functions: circular and longitudinal stripping, dismantling and cutting. This allows professional dismantling and stripping with just one tool.

Duo-Crimp No. 300

Stripping and crimping with just one tool

- ▶ insulation removal from 0,5 mm² to 6,0 mm²
- ▶ two crimping ranges are offered (0,5 - 2,5 mm² and 4,0 - 6,0 mm²) according to DIN 46228-2
- ▶ integrated, well accessible side cutter up to 6 mm²



mm	g	mm ²	Ømm	Art.-No.
160	116	0,5 - 6 (20 - 10 AWG)	-	51000300



STRIPPING + CRIMPING





Data-Strip No. 30

Inner blade can be set to the insulation thickness

- ▶ removal of the outer insulation on data cables
- ▶ stripping of conductors and stranded wires e.g. telephone lines
- ▶ precise stripping with adjustable length stop (3,5 - 14 mm)
- ▶ integrated, well accessible side cutter up to 8 mm Ø

mm	g	mm ²	Ømm	Art.-No.
125	60	0,05 - 0,5 (0,2 - 0,8 Ø) (30 - 20 AWG)	4 - 10	52000030

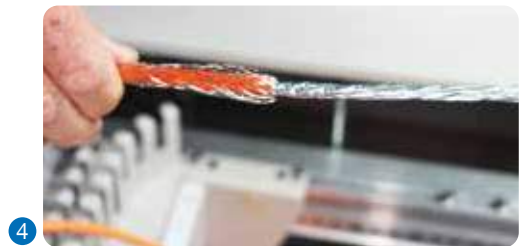
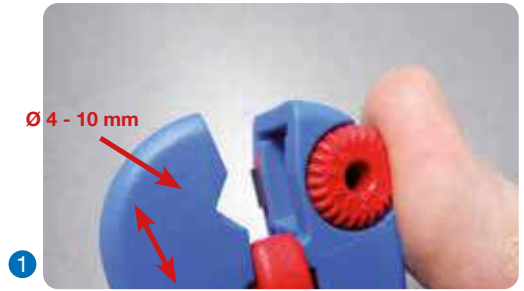

Stripper No. 100

Universal tool for dismantling and stripping

- ▶ for many different cable types in building installation
- ▶ flush stripping on ceilings and walls
- ▶ allows circular and longitudinal stripping

mm	g	mm ²	Ømm	Art.-No.
140	74	0,5 - 16 (20 - 6 AWG)	4 - 13	51000100

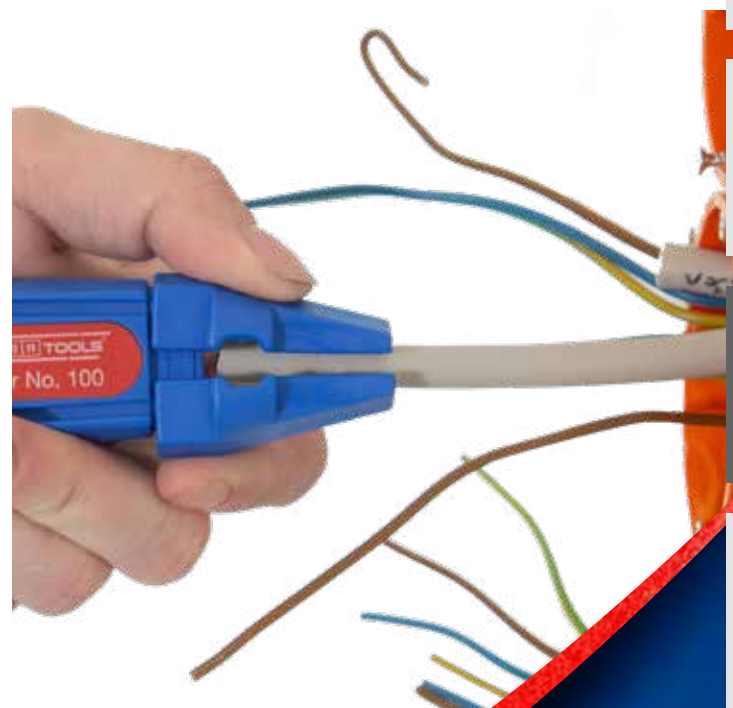

Adhesives / Sealants

Technical Sprays

Technical Liquids

Assembly Pastes

Lubricants

WEICON TOOLS®

Other

MULTI-PURPOSE STRIPPERS

Mini-Duo No. 150

Automatic wire stripper

- ▶ allows quick and accurate stripping
- ▶ precise work with integrated length scale
- ▶ easily accessible built-in side cutter for cables up to 6 mm²

mm	g	mm ²	Ømm	Art.-No.
160	112	0,5 - 6 (20 - 10 AWG)	-	51000150

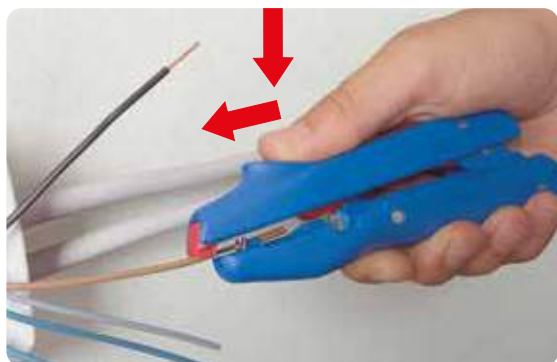

Duo-Stripper No. 200

Professional dismantling and stripping

- ▶ quick and simple stripping from 0,5 mm² to 6,0 mm²
- ▶ dismantling: Working range 4 - 28 mm Ø
- ▶ spare blade in the handle case

mm	g	mm ²	Ømm	Art.-No.
160	123	0,5 - 6 (20 - 10 AWG)	4 - 28	51000200





Multi-Stripper No. 400

Multifunctional with 4 functions

- ▶ circular cutting - longitudinal cutting - stripping - cutting
- ▶ flush stripping, even in hard-to-reach areas
- ▶ safe and space saving storage with closing clip

mm	g	mm ²	Ømm	Art.-No.
155	79	0,5 - 6 (20 - 10 AWG)	8 - 13	51000400

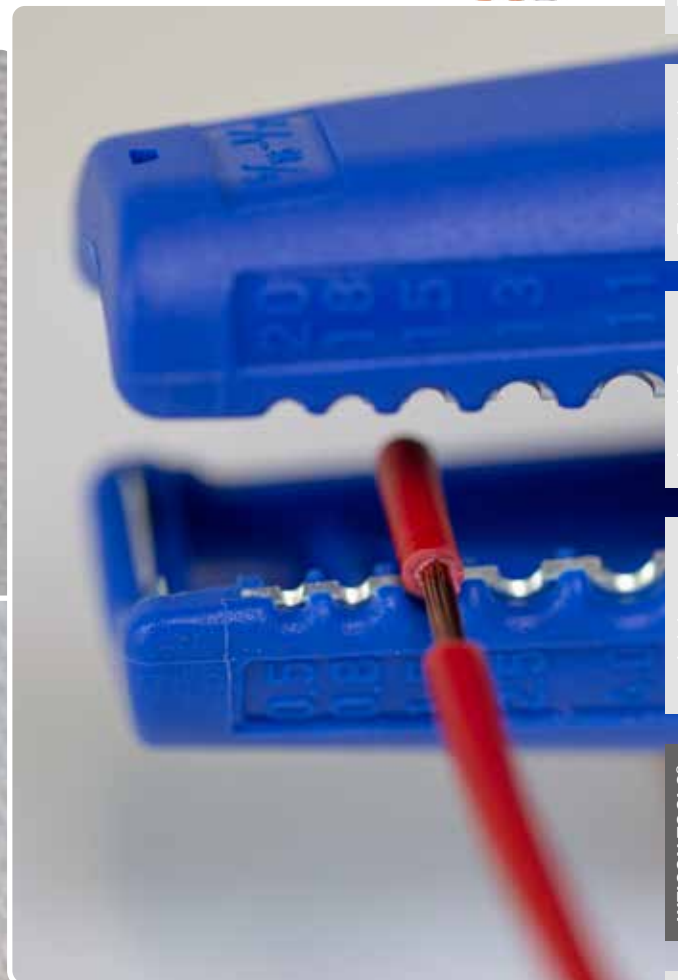

Adhesives / Sealants

Technical Sprays

Technical Liquids

Assembly Pastes

Lubricants

WEICON TOOLS®

Other

SPECIAL TOOLS

For a series of unusual applications, we provide you with special tools which meet these requirements. Whether it is the dismantling of large cable diameters, tools for the solar industry or working on high voltage cables, WEICON TOOLS has the solution!

Especially for the solar sector



Mini Solar No. 3

Special tools for dismantling and stripping of all common cables in the solar sector

- ▶ quick stripping of all common solar cables with outer diameters from 1,5 mm² to 6 mm²
- ▶ precise work with adjustable length stop (6 - 28 mm)
- ▶ integrated, well accessible side cutter up to 4 mm²

mm	g	mm ²	Ømm	Art.-No.
125	58	1,5 - 6 (15 - 9 AWG)	-	52002003



Wire Stripper No. 7 Solar

Special tools for dismantling and stripping of all common cables in the solar sector

- ▶ automatic wire stripper
- ▶ precise work with optical length scale (up to 26 mm)
- ▶ integrated, well accessible side cutter up to 3 mm Ø



mm	g	mm ²	Art.-No.
170	218	Solar cable 1,5 - 6 (15 - 9 AWG)	51002007

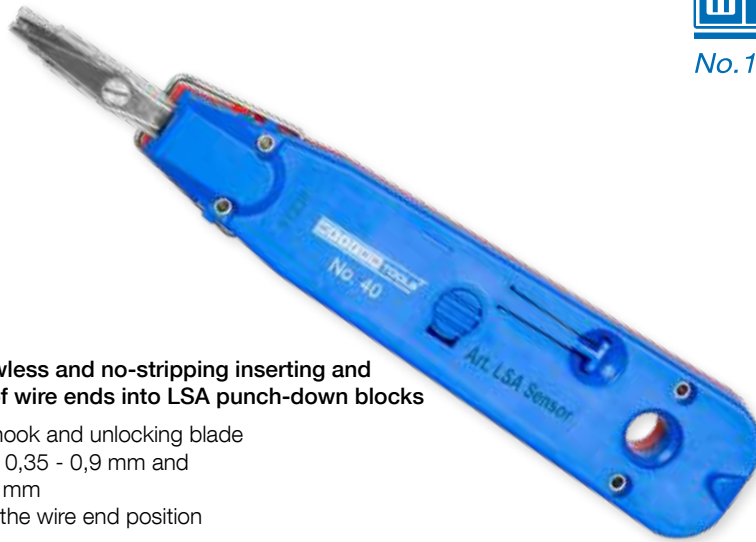

LSA Sensor No. 40

For the solderless, screwless and no-stripping inserting and simultaneously cutting of wire ends into LSA punch-down blocks

- ▶ with built-in retractable hook and unlocking blade
- ▶ for conductor diameters 0,35 - 0,9 mm and wire diameters 0,7 - 2,6 mm
- ▶ has a sensor for tracing the wire end position

mm	g	Ømm	Art.-No.
185	60	0,35 - 0,9	52000040

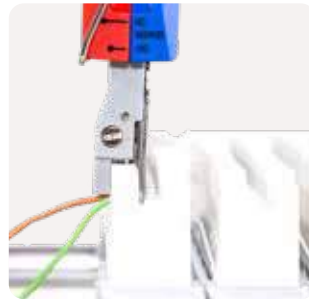
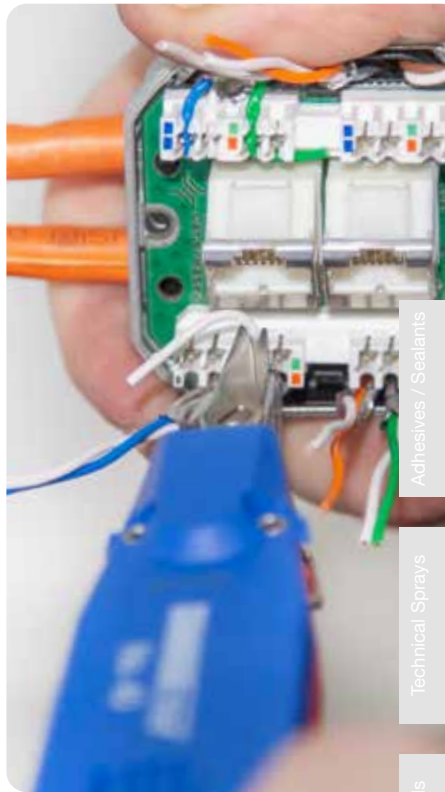

Cable Scissors No. 35

Cutting - stripping - crimping

- ▶ 2-component handles for increased safety
- ▶ high cutting performance
- ▶ blades made of special stainless steel

mm	g	Cu/Al	Cu/Al	Art.-No.
150	90	⊙ < 35 mm ²	⊙ < 50 mm ²	52000035

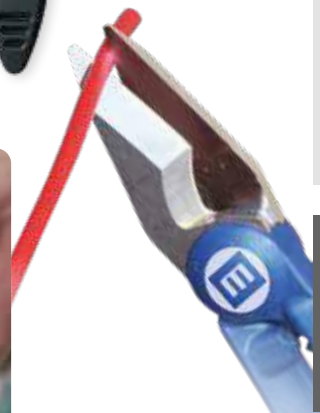

Adhesives / Sealants
Technical Sprays
Technical Liquids
Assembly Pastes
Lubricants
Other

SPECIAL TOOLS

Cable Stripper No. 4 - 29 Spiral

Round, longitudinal and spiral cutting for soft and rigid cable insulations

- ▶ working range 4,5 - 29 mm, cutting depth 0 - 3 mm
- ▶ cutting depth can be set comfortably and from 0 - 3 mm with lockable control knob



mm	g	Ømm	Art.-No.
140	136	4,5 - 29	52000029



Cable Stripper H.D. No. 1000

1000 V
IEC: 60900



Working under voltage up to 1000 Volt*
Unit testing according to DIN EN 60900

- ▶ quick cutting of multiple insulated cables
- ▶ conductor protection with the curved blade tip
- ▶ good transfer of force due to optimised handle shape

mm	g	Art.-No.
215	93	51001000

*Tools with safety insulation are basic prerequisites for working on equipment under voltage. Please always pay attention to the legal regulations and follow the corresponding safety advice!



Dismantling Tool No. 25

For convenient longitudinal and circular cuts

- ▶ safe work with the concealed blade
- ▶ conductor protection with the curved blade tip
- ▶ easy work, even at low temperatures
- ▶ precise, durable and replaceable turnover blade

mm	g	Ømm	mm	Art.-No.
210	163	>25 mm	0 - 5,0 mm	52000025



Adhesives / Sealants

Technical Sprays

Technical Liquids

Assembly Pastes

Lubricants

WEICON TOOLS®

Other

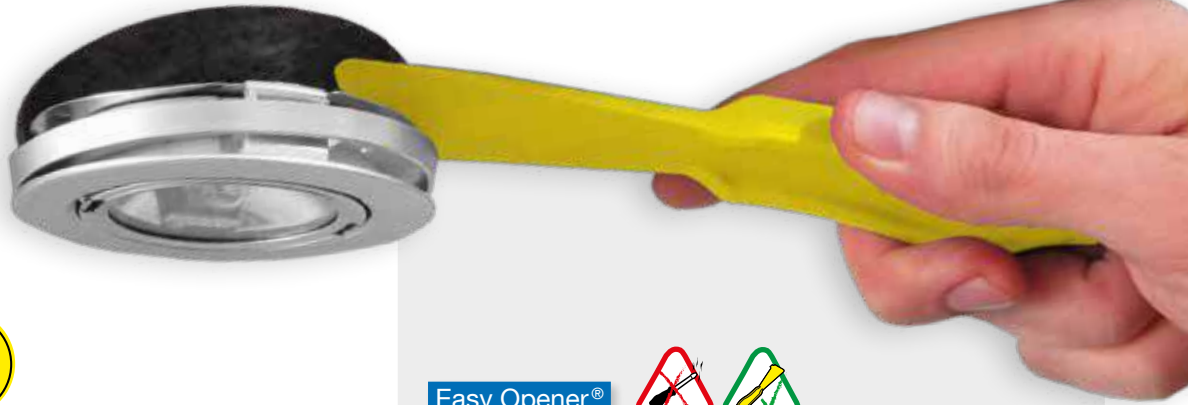

Multi-Opener



The ideal tool for the gentle opening of sensitive equipment and dismounting of clipped housings

- ▶ no scratching of sensitive surfaces
- ▶ conductive ESD material protects against electrostatic discharge
- ▶ flexible fibreglass-reinforced polyamide
- ▶ stainless steel blade to remove adhesive residues

mm	g	Surface Resistance	Art.-No.
180	22	approx. $10^9 \Omega$	52800000

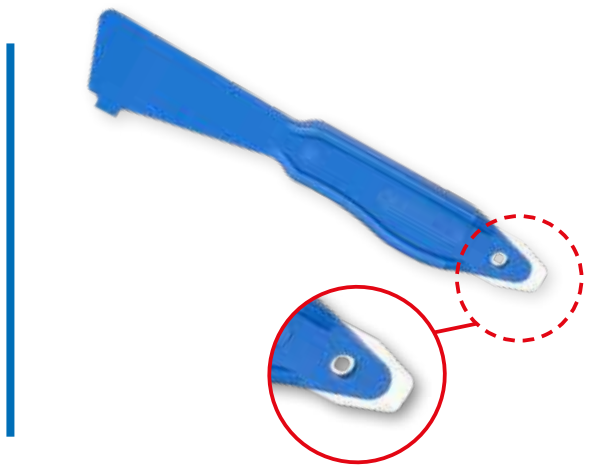

Easy Opener®



Special tool for the gentle disassembly of sensitive components without damaging the material

- ▶ ideal for loosening switches, luminaires or similar components
- ▶ flexible and stable at the same time
- ▶ three surfaces with different material thickness

mm	g	Art.-No.
180	22	52800001

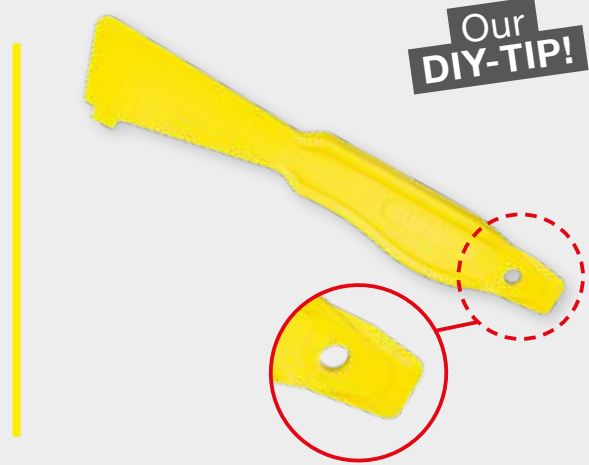

Adhesives / Sealants

Technical Sprays

Technical Liquids

Assembly Pastes

Lubricants

WEICON TOOLS®

Other

TOOL SETS

With our tool sets, we can offer solutions for almost all industries and the most different applications.

Crimp-Set Pro

Allround equipment for crimping with wire ends

- ▶ Duo-Crimp No. 300
- ▶ Wire Stripper No. 7 Magic
- ▶ high-quality shaker with 400 wire ends (0,5 - 2,5 mm²) according to DIN 46228

mm Length x Width x Height	g	Art.-No.
340 x 280 x 55	950	52880002

Starter-Set Pro

Ideal selection for house installation

- ▶ Wire Stripper No. 5
- ▶ Coax-Stripper No. 2
- ▶ Cable Stripper No. S 4-28
- ▶ Round Cable Stripper No. 13

mm Length x Width x Height	g	Art.-No.
255 x 210 x 60	575	52880001





Electrical Installation Set 1

- ▶ Duo-Crimp No. 300
- ▶ Round Cable Stripper No. 13

Art.-No.

52881001



Electrical Installation Set 3

- ▶ Wire Stripper No. 5
- ▶ Coax-Stripper No. 2

Art.-No.

52881003

**Our
Electrical Installation Sets**

Electrical Installation Set 2

- ▶ Wire Stripper No. 5
- ▶ Cable Stripper No. S 4-28

Art.-No.

52881002

Electrical Installation Set 4

- ▶ Wire Stripper No. 5
- ▶ Round Cable Stripper No. 13

Art.-No.

52881004



Adhesives / Sealants

Technical Sprays

Technical Liquids

Assembly Pastes

Lubricants

WEICON TOOLS®

Other

SPARE PARTS AND SALES AIDS

Art. No.	Name	PU	
50100002	Spare blade for Cable Stripper series S 4 - 28 <i>Inner blade</i>	1	
50100001	Spare blade for Cable Strippers <i>Inner blade</i>	1	
51100008	Spare blade for No. 200 <i>Inner blade</i>	1	
51100002	Spare blade set No. 5/No. 6 <i>2 blades + 1 screw</i>	1	
51100006	Spare blade set No. 7 Magic <i>2 blades + 4 screws</i>	1	
51100007	Spare blade set No. 7-F <i>2 blades + 4 screws</i>	1	
51100005	Spare blade set No. 7 Solar	1	
52953030	Spare blade set No. 30 Data-Strip <i>1 blade + adjusting screw</i>	1	
51953020	Spare blade set for No. 150 / No. 200 / No. 300	1	
52953020	Spare blade for Dismantling Tool No. 25 <i>Double edge blade</i>	1	
52953050	Spare blade for Cable Stripper 4-29 Spiral	1	
52953040	Hook knife for No. 16 <i>1 hook knife 1 slider + 1 screw</i>	1	
52100008	Inserts for No.1 F Plus 6/4	6	
52100009	Inserts for No.1 F Plus 6,5/6,5	6	
52100010	Inserts for No.1 F Plus 6/4	6	



Display Cable Stripper
50951050



WEICON TOOLS Display
50952000
WEICON TOOLS Display with LED lighting
50952000-LICHT



Roll-Up
99951078

Stickers

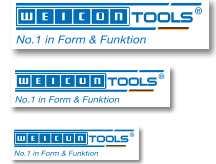

Poster

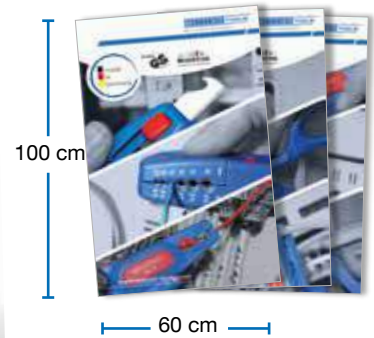

Foam Display without tools
50951199

Example: 12x Dismantler



Foam Display without tools
50951198

Example: 6x Wire Stripper

Adhesives / Sealants

Technical Sprays

Technical Liquids

Assembly Pastes

Lubricants

WEICON TOOLS®

Other



Pre- and Post-treatment of Surfaces

Adhesives / Sealants	Primer M 100	25 ml	Pre-treatment for bonding non-absorbent surfaces like metals, plastics, lacquered surfaces	13550102
		250 ml		13550125
	Primer K 200	25 ml	Pre-treatment for bonding non-absorbent surfaces and lacquered plastic surfaces as well as elastomers e.g. EPDM.	13550202
		250 ml		13550225
	Primer S 300	25 ml	Pre-treatment of porous and absorbent background.	13550302
		250 ml		13550325
	Primer P 400	25 ml	Pre-treatment of polyolefines e.g. TPE, PE, PP.	13550402
		250 ml		13550425
	Primer E 500	25 ml	Especially for silicone - for pre-treating non-absorbent surfaces such as aluminium, VA steel, brass, copper, zinc, tinplate and enamel, ceramic and glass as well as plastics such as ABS, PVC hard, PA6.6, GFC etc.	13558002
		250 ml		13558025
	Primer G	50 g	Special bonding agent for urethanes to pre-treat rubber and metal surfaces.	10809050
Technical Sprays	Smoothing Agent	500 ml	The Smoothing Agent is a transparent mixture of non-ionic surface activators. Applying it makes it possible to easily and cleanly smoothe all WEICON Elastic Adhesives and Sealants such as silicone, MS polymers, polyurethane, etc. prior to skin formation.	13559500
		5 L		13559505
	Activator for RK-1300 & RK-1500	100 ml	Activator (100 ml pump dispenser or 1 l bottle) for processing RK cartridges and large containers.	10562100
		1 L		10562901
Technical Liquids	CA Primer for Polyolefines	10 ml	Pre-treatment for bonding polyolefines in combination with WEICON Contact Cyanoacrylates.	12450010
		100 ml		12450100
		1 L		12450901
	CA-Activator Spray	150 ml	Accelerates the curing time of WEICON Contact Cyanoacrylate Adhesives.	12500150
		1 L		12500901
	CA-Activator Spray AC	150 ml	Activator for cyanoacrylate adhesive on the basis of acetone. For joints without "blooming" effect, especially with high-viscosity types and larger adhesive layers.	12505150
		1 L		12505901
Assembly Pastes	CA-Remover	30 ml	Breaks down and removes all types of cyanoacrylate adhesives. Suitable for cleaning metal parts, tools, and many other surfaces that have come into contact with cyanoacrylate adhesives.	12470030
Lubricants	Surface Cleaner	150 ml	WEICON Surface Cleaner is used for the cleaning and degreasing of surfaces to be joined or sealed with WEICON Adhesives and Sealants.	11207150
		400 ml		11207400
		1 L		15207001
		5 L		15207005
		10 L		15207010
		28 L		15207028
WEICON TOOLS®	Activator F Spray	200 ml	Pre-treatment with WEICON Activator F can reduce the curing time considerably. The Activator is recommended for all passive surfaces as well as for low ambient temperatures (< +10°C/+50°C) and for large bonding gaps.	30700200
	Activator F Liquid	1 L	On non-metallic surfaces, only the Activator enables WEICONLOCK to cure. To achieve fast curing on passive surfaces even if no activator is or ought to be used, we recommend the use of the types AN 302-44, AN 302-60, AN 302-80, AN 306-10, AN 306-30 and AN 305-78. The initial strength is reached faster than with the standard types (without Activator).	30700501
	Mould release agent Wax P 500	500 g	Wax P 500 is a release agent on a waxy basis for epoxy resins and polyurethanes. It is especially suitable for release processes from rough and/or porous surfaces.	10604500
	Mould release agent Liquid F 1000	1 L	Liquid F 1000 is a release agent on a waxy basis for epoxy resins and polyurethanes. It is especially suitable for release processes from smooth and non-absorbent surfaces.	10604000



Ancillary Products and Accessories

Mixing and Dosing Systems

Easy-Mix Hand Dispenser D 50	Suitable for all Easy-Mix types and PEP-PP 50	10653050	Adhesives / Sealants
Hand Dispenser PE-PP	Only suitable for Easy-Mix PE-PP 45.	10663045	
Special Piston PE-PP	For retooling the Hand Dispenser Easy-Mix D 50 to Easy-Mix PE-PP 45.	10663110	
Mixing Nozzles PE-PP	Only suitable for Easy-Mix PE-PP 45.	10660002	
Quadro Mixing Nozzle	Quadro Mixing Nozzle suitable for all Easy-Mix types (except Easy-Mix Metal, HT 180 and HT 250)	10650005	
Helix Mixing Nozzle	Helix Mixing Nozzle suitable for Easy-Mix Metal, HT 180 and HT 250	10650006	
Glass Fibre Cloth Tape	Improves adhesion and pressure resistance of WEICON epoxy resins at many repair and maintenance jobs.	10850005	
Injection Packer Set	System for gap compensation on bridges, pillars, machines, and plants. For processing gap-bridging products (WEICON Plastic Metal). The Injection Packer Set comprises a threaded nozzle R1/4"-8 PA6, one metre tube PE 10x8 mm, and a tube valve PE. Injection Packers are available in the sizes 50x30x10 mm and 50x25x25 mm.	10851020	Technical Sprays
	Injection Packer / flat	10851022	
	Injection Packer / rectangular	10851021	
Processing Spatula	small (20,5 cm)	For universal use, e. g. processing of two-component adhesives, application of epoxy pastes, removal of adhesive residues, and many others. Available in two different sizes.	10953001
	large (25,5 cm)		
Universal Spatula White	Special spatula for the gentle removal of the most diverse contamination and residues.	10953008	Technical Liquids
Contour Spatula Flexy	Versatile use, e.g. for coating and processing two-component adhesives. The spatula is perfect for applying adhesives on large or small surfaces. The spatula is made of wear-resistant polyamide.	10953020	
Spiral Stirrer stainless steel	Spiral stirrer stainless steel.	10953010	
Double Nozzle	Multifunctional spray head for exact dosage in areas difficult to access. Suitable for more than 40 WEICON sprays.	11953058	Assembly Pastes
Dosing Tips Type A	Dosing tip for all WEICON Easy-Mix types. WEICON RK-7000/-7100/-7200, RK 7300 for even finer dosing.	12955175	
Dosing Tips Size 0	For exact, economic and point-to-point applications of WEICON Contact Adhesives.	12955170	
Dosing Tips L Size 1	For exact, economic and point-to-point applications of WEICONLOCK.	30955172	Lubricants
Cartridge Gun "Standard"	For low and medium viscosity adhesives. Suitable for standard cartridges up to 310 ml.	13250001	
Cartridge Gun "Special"	Professional quality. Recommended for medium and high viscosity adhesives. Suitable for standard cartridges up to 310 ml.	13250002	
Compressed Air Cartridge Gun	For low and medium viscosity materials (310 ml cartridges). 1.45 kN thrust at 6.8 bar operating pressure.	13250009	WEICON TOOLS®
Dispenser 2C 10:1	Recommended for the 2-component 540g cartridge.	10653491	
Mixing Nozzle MFHX	Suitable for Urethane 85 (540-g-Cartridge)	10650027	
Cartridge Cutter	For problem-free and safe cutting of plastic cartridge caps as well as for vertical or bevelled cutting of cartridge nozzles.	13250000	Other
Special Mixing Nozzle	For Flex 310 M 2 K fast curing.	13309997	
V-Joint Nozzle	For all one-component standard cartridges.	13955031	
Primer Applicator	For application of WEICON Primer.	13955050	
Presspack Dosing Tip	Dosing tip for the WEICON products Plast-o-Seal, Flex+bond, Black-Seal, Anti-Seize and Copper Paste in the presspack.	13955072	
Presspack Ergo Connect	Ergonomic dosing tip for WEICON Presspack products. Fatigue-free working thanks to optimised angle geometry. The two-way thread enables an application radius of 180°. Compatible with WEICON dosing tip and brush top.	13890002	
Pump Dispenser WPS 1500	Refillable pump dispenser for many WEICON liquids.	15841500	
Pump Dispenser WPS 1500 with VITON-seals	Refillable plastic sprayer with VITON seal set especially for WEICON Rust Loosener, WEICON W44T and WEICON AT44.	15841500-V	
Extension Piece for WPS 1500	Plastic prolongation 30 cm with nozzle 0,8mm (plastic).	15841501	
Gasket Kit EPDM	Gasket Kit EPDM for Pump-Dispenser WPS 1500	15841502	
Gasket Kit Viton	Gasket Kit Viton for Pump Dispenser WPS 1500 V	15841503	
Pressurized-Air Spray Can WSD 400	Pressurized-Air Spray Can - refillable.	15811400	
Spray Valve Set for WSD 400	Valve Set (four different valves and a ball valve with dip tube).	15811002	
Adapter for WSD 400	Adapter for filling from the compressed-air mains.	15810001	
Pump Dispenser "Standard"	For all WEICON Technical Liquids which are free of solvents and mineral oil.	15842001	
Pump Dispenser "Special"	For WEICON Cleaner S, Brake Cleaner and Rust Loosener.	15843001	
Adjusting Valve for Cans	5 and 10 L 28 L For the exact dosage of WEICON Technical Liquids from the can.	15831001	
Presspack Brush Top	WEICON Presspack brush top for Anti-Seize.	26955007	



Adhesives / Sealants



Agricultural Technology



Building Trades



Mining



Stainless Steel

Technical Sprays



Electrical Installation



Energy Technology



Automotive and Transport



Rubber and Plastic Industry

Technical Liquids



Hydraulics and Pneumatics



Maintenance



Food, Pharmaceutical and Cosmetic Industry



Mechanical Engineering

Assembly Pastes



Oil and Gas



Marine Industry



Tooling, Model and Mould Making Industry



Occupational Safety and Process Optimization

Lubricants

WEICON TOOLS®

Other



Drive and Conveyor Technology



Application Areas



Simply find solutions.

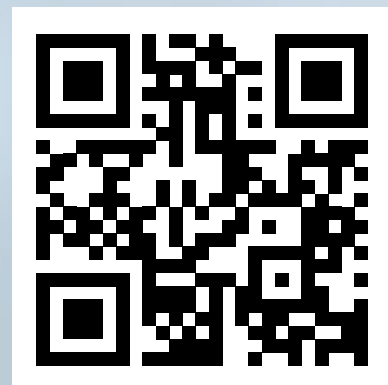
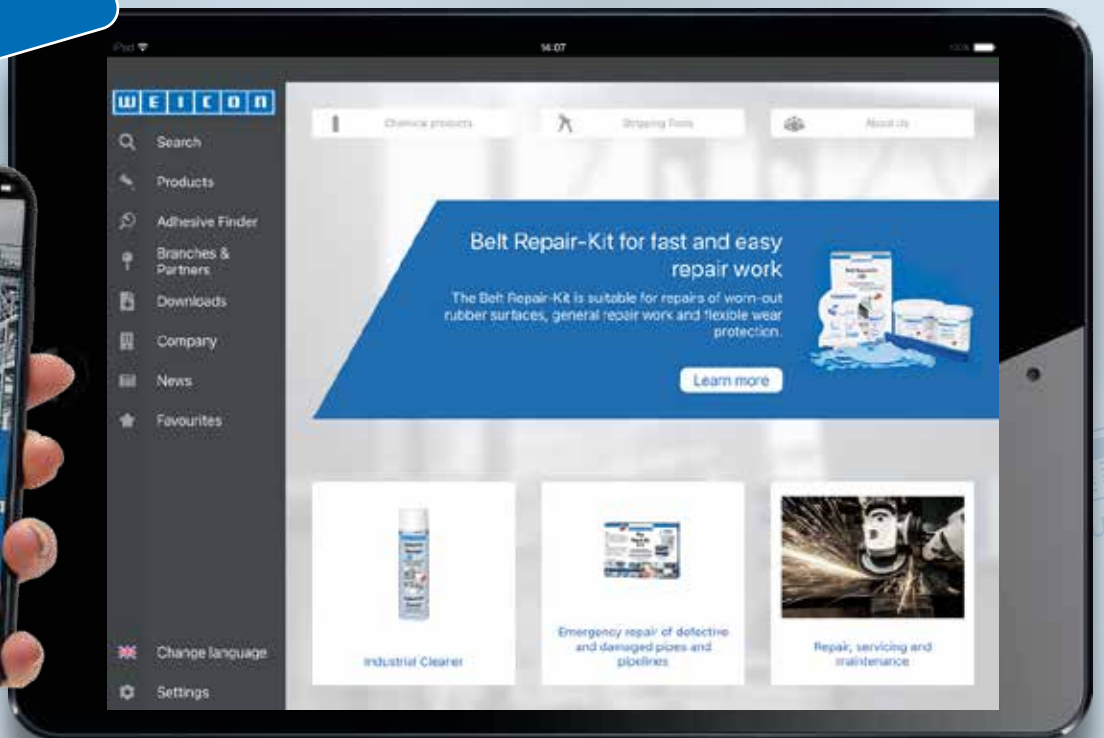

www.weicon.de/app





Floor and Foam Displays

Equipment suggestion. Supply of the displays is without products.



Display WEICON Spray
11951080



Display WEICONLOCK Pen
30951080



Display Cable Stripper
50951050



WEICONLOCK
30 x 50 ml oval
30951190



Lock 50 ml
half oval
30951194



CA 30g/Lock 20 ml
half oval
12951092



Cartridges 310 ml
half oval
13951096



Tubes 85 ml
half oval
13951097

Product Presentation

Floor Displays

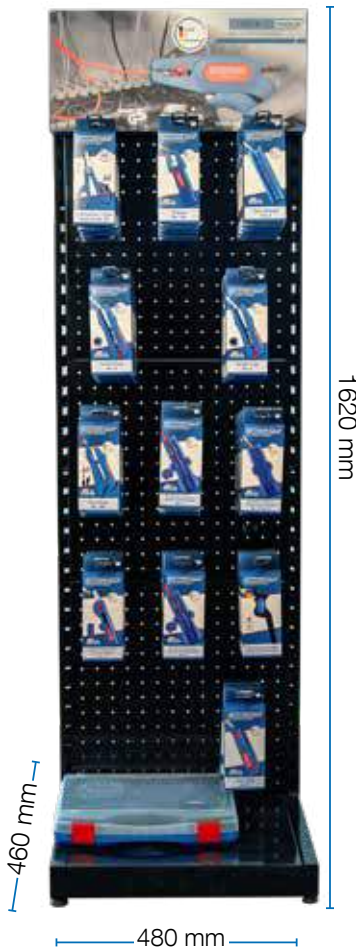

WEICONTOOLS Shelf System
50952000

WEICONTOOLS Shelf System
with LED-light
50952000-LICHT



Floor Display Universal
11951078



Roll-Up WEICON
99951073

Roll-Up WEICON TOOLS
99951078

Counter Displays



Display
500 ml Spray 11951079
400 ml Spray 11951082

Inlay 400 ml
Multi Foam 11951089
Citrus Cleaner 11951088
AT-44 11951087
W 44 T 11951086
Surface Cleaner 11951085
Silicone Spray 11951084
Zinc-Spray bright grade 11951083
Rust Converter 11951107

Inlay 500 ml
W 44 T 11951096
Industrial Cleaner 11951097
Cleaner Spray 11951094



Sales Display Double Syringe
10951060

Inlay
10950155-D



Product Presentation



Brochure Display Stand



Brochure Display Stand
 DIN A4
 99951038



Brochure Display Stand
 DIN Lang Fourfold
 99951042



Brochure Display Stand
 (wire) DIN A4 Fourfold
 99960053



Brochure Display Stand
 Shelf System
 99951041



Brochure Display Stand
 Small DIN A5
 99955213



Brochure Display Stand
 Shelf System DIN A4
 99951049

Equipment suggestion. Supply of the displays is without products.

Product Presentation

Foam Displays for Shelves



Repair Sticks 57 g / 115 g
10951090



Presspack
13951095



Cartridges
13951090



Tubes 85 ml
13951093



WEICONLOCK® 10 ml
12951090



WEICONLOCK® 20 ml
12951091



WEICONLOCK® 50 ml
30951191



CA-Adhesives 12 g
12951090



CA-Adhesives 30 g
12951091



WEICON Pen 30 g
without base
30951193



WEICON Plast-o-Seal®
30951192



Smoke Detector Test
Spray
11951090



Foam block
without tools
Example 12x Cable Stripper
50951199



Foam block
without tools
Example 6x Cable Stripper
50951198

Adhesives / Sealants

Technical Sprays

Technical Liquids

Assembly Pastes

Lubricants

WEICON TOOLS®

Other

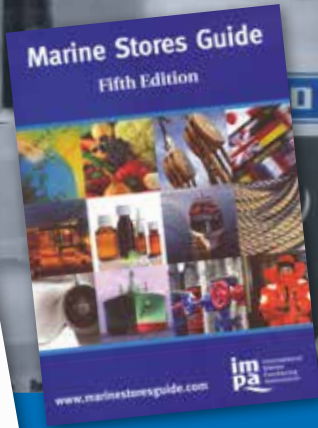

Certified for quality, technology and safety



ISEGA

Certificates of Conformity for WEICON Ceramic BL, WEICON GL-S, WEICON Flex 310 M[®] Crystal, Flex 310 M[®] liquid, Flex 310 M[®] Stainless steel, Flex 310 M[®] ProSeal, Flex 310 PU, Flex 310 M[®] Classic, Windscreen Adhesive, Flex+bond[®], Flex+bond[®] liquid (white and black), Aqua-Flex, Speed-Flex[®], Speed-Flex[®] Crystal, Silicone LP WEICONLOCK SI 303-31, Contact VA 20, VA 100, VA 8312 and VA 8406 as adhesives in the foodstuff technology.



Nonfood Compounds Program Listed (Category Code) (Registration #)

NSF

Cleaning and polisher C1: Metal-Fluid
 Cleaning and polisher A7: Metal-Fluid and Stainless Steel Care Spray A7
 Lubricants H1: Bio-Fluid, Silicone-Fluid, W 44 T Fluid, Rust Loosener Fluid, Spray-on Grease H1, Anti-Seize High Tech Assembly paste ASW, Allround Lubricant AL-H, Silicone Grease



Certified to NSF/ANSI 61

Lubricants H2:

Allround Lubricant AL-F, Top Lube Fluid, PTFE Fluid

Solvent cleaner A1:

Fast Cleaner, Foam Cleaner

Solvent cleaner K1, K3:

Industrial Cleaner

Adhesives and Sealants S4:

VA 1401

Adhesives and Sealants S2:

Silicone LP, SI 303-31, AN 305-77

Drinking water systems and components

NSF/ANSI Standard 61:

WEICONLOCK types AN 301-38, AN 301-43, AN 301-48, AN 301-65, AN 301-70, AN 301-72, Contact VA 110, Repair-Stick types Copper, Steel, Plastic, Stainless steel, Multi-Purpose, Pipe Repair-Kit CA Activator Spray and CA Activator Spray AC
 Zinc Spray and Zinc Spray bright grade

Other P1:

Coatings R2:



DNV

Approval of reactive plastics for the use and repair of components in the maritime industry (WEICON A, SF, GL-S and Ceramic BL).



MED

The European Marine Equipment Directive MED is the main set of regulations on the subject of marine equipment. The certification verifies that the products meet fire safety standards tested in an accredited IMO/MED laboratory. Flex 310 M[®] FireSeal and Flex 310 M[®] ProSeal.



ISSA

ISSA (International Shipsuppliers & Services Association) is an international association of nearly 2.000 ship suppliers worldwide. Meanwhile, members of ISSA supply more than 500 locations with equipment.



IMPA

IMPA (International Marine Purchasing Association) is an advocacy which promotes a close cooperation between buyers and suppliers in the maritime industry. The association has set itself the goal to improve the understanding between buyers and suppliers in the global maritime economy. The organisation was founded in 1978 and represents almost 1.000 member worldwide today. Since October 2020, WEICON has been holding the status as official supplier. **Many of our products can be found in the ISSA and IMPA Catalogue.**

Russian Maritime Register of Shipping

WEICON is inspected every three years by one expert each for high-sea navigation as well as inland shipping of the Russian Maritime Register of Shipping.



Adhesives / Sealants
 Technical Sprays
 Technical Liquids
 Assembly Pastes
 Lubricants
 WEICON TOOLS[®]
 Other

References/Certificates

Top Products



Supplier of the Year 2021

The professional association of technical retailers 'VTH Verband Technischer Handel e. V.' is also convinced of our exceptional range of services. The association and its members of the technical retail awarded us the title "Supplier of the Year" in the product group of adhesives for a good reason.

Red Dot Winner

The „Red Dot“ award is one of the most renowned hallmarks worldwide for excellent and well-thought-out design. The award, which has been given out since 1955, recognises the best products each year.

TÜV NORD

Certificates stating the compliance with special quality standards of WEICON Zinc Spray, WEICON Zinc Spray „bright grade“ and WEICON Corro Protection. Safety approvals of the German TÜV stating that WEICON TOOLS Stripping Tools comply with the federal regulations on technical working equipment.

DVGW

Test mark certificates for WEICONLOCK Anaerobic Adhesives/Sealants types AN 301-43, AN 301-48, AN 301-72, AN 302-40, AN 302-43, AN 302-44, AN 302-45, AN 302-70, AN 302-72, AN 305-11, AN 305-42, AN 305-72, AN 305-77, AN 305-78, AN 306-20 and Thread Sealing Cord DF 175. Test mark certificate for WEICON Leak Detection Spray, Leak Detection Spray Frost-proof and Leak Detection Spray Viscous for use in gas supply systems.

BAM

BAM tested and safety-related evaluated- according to leaflet M 031-1 "List of nonmetallic materials compatible with oxygen" (DGUV information 213-078) of BG RCI AN 302-75, AN 305-77, AN 305-78, AN 306-20, AN 306-30, AN 305-10 and Thread Sealing Cord DF 175, Silicone Grease

Bundespreis 2000

For WEICON Duo-Crimp No. 300 as an outstanding innovative achievement.

AGA - Australian Gas Association

Certificate for WEICONLOCK AN 305-10, 305-72, 305-77, for jointing compounds and materials for use in gas pipe joints.

Hygiene-Institut des Ruhrgebiets

Hygienic assessment in contact with water.

Anaerobic adhesives: WEICONLOCK AN 302-42, AN 302-43, AN 302-44, AN 302-70, AN 302-72, AN 305-11, AN 305-72, AN 305-77, AN 305-78, AN 306-10, AN 306-20, AN 306-38, AN 306-48 AN 302-60 AN 302-80, AN 306-30

High Performance Greases: Silicone Grease
Pipe and Thread Sealing: WEICONLOCK SI 303-31
Silicone: Silicone LP

WRAS

WRC-approval for Great Britain. WEICONLOCK AN 305-77, AN 306-20, AN 301-48, AN 301-72, WEICON Thread Sealing Cord DF 175

ABS

The „American Bureau of Shipping“ is one of the leading classification societies for ships, oilrigs, and other maritime constructions and their components.

ASTM

The ASTM is a standardisation organisation publishing technical standards for products and services.



reddot winner 2020



Adhesives / Sealants

Technical Sprays

Technical Liquids

Assembly Pastes

Lubricants

WEICON TOOLS®

Other



Securing the transport of an oilrig with WEICON Plastic Metal RFC, a specially developed type for extreme requirements in the off-shore sector.

1.500 – 2.000 kg of WEICON Plastic Metal RFC are used for each transport job.

Previous solution:

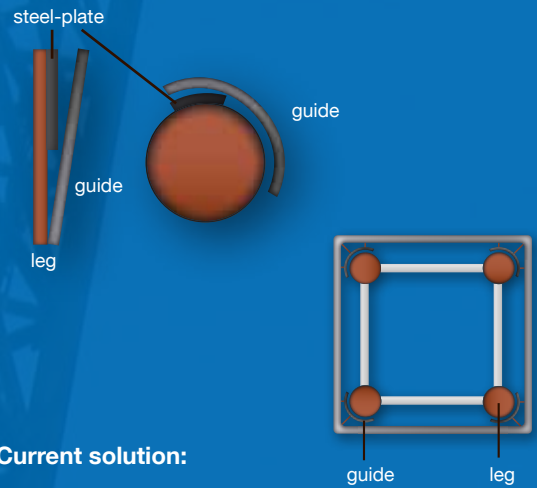

Current solution:

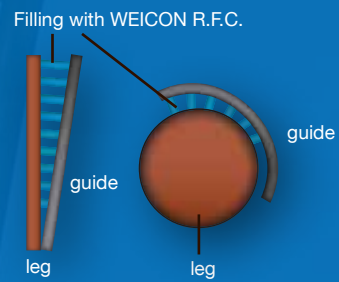

Offshore

Transport of an Oilrig



Adhesives / Sealants

Technical Sprays

Technical Liquids

Assembly Pastes

Lubricants

WEICON TOOLS®

Other

BIKE CARESET

- ☑ clean your bike
- ☑ lather thoroughly
- ☑ clean your bicycle drive
- ☑ polish your bike
- ☑ oil your bike chain
- ☑ protect screw connections
- ☑ secure screws



Art.Nr. 11951078
Equipment suggestion. Supply of the displays is without products.

13 products



Art.-No. 70890001

3 products



Art.-No. 70890002



CAMPING SET CLEANING AND CARE

A camping trip means relaxing and adventure at the same time. Just quickly hitch the caravan to your car, hop in the campervan or stow your tent in the trunk – and let the holiday begin!

Whether for camping enthusiasts travelling with a caravan, motorhome, campervan, vintage van, or tent – the set is a reliable helper on every adventure trip and, thanks to the handy storage bag made of natural fibre, can be easily stored everywhere.



Art.Nr. 72000001



Adhesives / Sealants

Technical Sprays

Technical Liquids

Assembly Pastes

Lubricants

WEICON TOOLS®

Other

Adhering Grease extra strong	149	Flex-bond® Liquid	103	W 44 T® (Spray)	144
Adhesive Spray	151	Foam Cleaner	135	W 44 T®-Fluid	144
Adhesive Spray (Liquid)	176	Freeze Spray	155	WEICONLOCK Activator F	61
Adhesive Spray extra strong	151	Galva-Spray	125	WEICONLOCK AN 301-38	70
Adhesive Spray for detachable joints	151	Gasket Maker	80	WEICONLOCK AN 301-43	62
AL-F	188	GMK 2410	121	WEICONLOCK AN 301-48	70
AL-H	188	GMK 2510	120	WEICONLOCK AN 301-65	66, 74
AL-M	189	Gold-Spray	129	WEICONLOCK AN 301-70	62
AL-T	188	Hand Protective Foam	139	WEICONLOCK AN 301-72	66, 74
AL-W	189	HT 300	111	WEICONLOCK AN 302-21	62
Allround Sealing Spray	154	Industrial Cleaner	133	WEICONLOCK AN 302-22	62
Alu Grinding Protection	143	Isolation Spray	128	WEICONLOCK AN 302-25	66
Aluminium Minute Adhesive	42	Label Remover (Liquid)	170	WEICONLOCK AN 302-40	62
Aluminium Minute Adhesive Set	42	Label Remover (Spray)	142	WEICONLOCK AN 302-41	63
Aluminium Paint	162	Leak Detection Spray	152	WEICONLOCK AN 302-42	63
Aluminium-Spray A-100	126	Leak Detection Spray frost-proof	152	WEICONLOCK AN 302-43	63
Aluminium-Spray A-400	126	Leak Detection Spray viscous	152	WEICONLOCK AN 302-44	63
Anti-Friction Spray MoS ₂	147	Leak Detector	176	WEICONLOCK AN 302-45	66
Anti-Seize	182	Leak Detector frost-proof	176	WEICONLOCK AN 302-50	64
Anti-Seize Assembly Spray	150	Leak Detector viscous	176	WEICONLOCK AN 302-60	64
Anti-Seize Assembly Spray High-Tech	150	Marine Emergency Repair Kits	34	WEICONLOCK AN 302-62	64
Anti-Seize High-Tech	182	Metal-Fluid (Liquid)	168	WEICONLOCK AN 302-70	64
Anti-Seize Nickel	184	Metal-Fluid (Spray)	138	WEICONLOCK AN 302-71	64
Anti-Spatter Spray	143	Mould Cleaner (Liquid)	164	WEICONLOCK AN 302-72	65
Aqua-Flex	105	Mould Cleaner (Spray)	134	WEICONLOCK AN 302-75	66
AT-44 (Liquid)	173	Mould Release Agent (Liquid)	171	WEICONLOCK AN 302-77	67
AT-44 (Spray)	145	Mould Release Agent (Spray)	142	WEICONLOCK AN 302-80	67
Belt Dressing Spray	139	Mounting Tapes	118	WEICONLOCK AN 302-90	65
Belt Repair-Kit	33	Multi-Foam	135	WEICONLOCK AN 302-90	74
Bike Care Set	230	Parts and Assembly Cleaner (Liquid)	166	WEICONLOCK AN 305-10	67
Bio Welding Protection	171	Parts and Assembly Cleaner (Spray)	134	WEICONLOCK AN 305-18	74
Bio-Cut (Liquid)	174	Pipe Repair Kits	32	WEICONLOCK AN 305-42	68
Bio-Cut (Spray)	145	Plastic-Cleaner (Liquid)	166	WEICONLOCK AN 305-67	68, 74
Bio-Fluid (Liquid)	174	Plastic-Cleaner (Spray)	133	WEICONLOCK AN 305-72	68, 75
Bio-Fluid (Spray)	145	Plastic Metal WEICON A	21	WEICONLOCK AN 305-73	75
Black-Seal	111	Plastic Metal WEICON B	21	WEICONLOCK AN 305-74	75
Brake Cleaner (Liquid)	166	Plastic Metal WEICON BR	22	WEICONLOCK AN 305-77	68
Brake Cleaner (Spray)	133	Plastic Metal WEICON C	21	WEICONLOCK AN 305-78	69
Brass Spray	129	Plastic Metal WEICON Casting Resin MS 1000	26	WEICONLOCK AN 305-86	69
Brushable Liquid Zinc Coating	162	Plastic Metal WEICON Casting Resin Plus 90	26	WEICONLOCK AN 306-00	70
Brushable Liquid Zinc Paint	162	Plastic Metal WEICON CBC	30	WEICONLOCK AN 306-01	70
Burner Cleaner	134	Plastic Metal WEICON Ceramic BL	23	WEICONLOCK AN 306-03	71
Cartridge Gun	109	Plastic Metal WEICON Ceramic W	24	WEICONLOCK AN 306-10	71
Cartridge Gun „Special“	109	Plastic Metal WEICON F	22	WEICONLOCK AN 306-20	71
Ceramic Anti-Spatter Spray	143	Plastic Metal WEICON F2	22	WEICONLOCK AN 306-30	71
Chain and Rope Lube Spray	148	Plastic Metal WEICON GL	23	WEICONLOCK AN 306-38	72
Chewing Gum Remover	142	Plastic Metal WEICON GL-S	23	WEICONLOCK AN 306-40	72
Chrome-Silver Spray	128	Plastic Metal WEICON HB 300	22	WEICONLOCK AN 306-41	72
Citrus Cleaner (Liquid)	167	Plastic Metal WEICON HP	25	WEICONLOCK AN 306-48	73
Citrus Cleaner (Spray)	135	Plastic Metal WEICON SF	24	WEICONLOCK AN 306-60	73
Cleaner S	165	Plastic Metal WEICON ST	26	WEICONLOCK SI 303-31	67
Cleaner Spray S	132	Plastic Metal WEICON TI	24	WEICONTOOLS Cable Scissors No. 35	211
Cleaner M	164	Plastic Metal WEICON UW	25	WEICONTOOLS Cable Stripper H.D. No. 1000	212
Cockpit-Spray	138	Plastic Metal WEICON WP	24	WEICONTOOLS Cable Stripper No. 28 - 35	197
Compressed Air Cartridge Gun	109	Plastic Metal WEICON WR	26	WEICONTOOLS Cable Stripper No. 35 - 50	197
Compressed-Air Spray	136	Plastic Metal WEICON WR2	26	WEICONTOOLS Cable Stripper No. 4 - 16	197
Contact Activator	93	Plastic-Bond	53	WEICONTOOLS Cable Stripper No. 4 - 28 G	197
Contact CA-Remover	93	Plastic-Bond Set	53	WEICONTOOLS Cable Stripper No. 4 - 28 H	197
Contact Filler	85	Plast-o-Seal®	81	WEICONTOOLS Cable Stripper No. 4-29 Spiral	212
Contact GEL	87	Pneuma-Lube (Liquid)	175	WEICONTOOLS Cable Stripper No. 8 - 27	197
Contact O-Ring Bonding Set	92	Pneuma-Lube (Spray)	146	WEICONTOOLS Cable Stripper No. C 4 - 16	197
Contact Primer for Polyolefines	93	Primer Applicator	46, 117	WEICONTOOLS Cable Stripper No. C 4 - 28	197
Contact Spray	141	Primer E 500	117	WEICONTOOLS Cable Stripper No. C 8 - 27	197
Contact VA 100	86	Primer G	46	WEICONTOOLS Cable Stripper No. S 4 - 28	196
Contact VA 110	86	Primer K 200	117	WEICONTOOLS Cable Stripper No. S 4 - 28 Multi	196
Contact VA 1401	87	Primer M 100	46, 117	WEICONTOOLS Cat Cable-Stripper No. 10	204
Contact VA 1403	90	Primer P 400	117	WEICONTOOLS Coax-Stripper No. 1 F Plus	202
Contact VA 1408	90	Primer S 300	46, 117	WEICONTOOLS Coax-Stripper No. 2	203
Contact VA 1460	90	PTFE-Fluid	147	WEICONTOOLS Coax-Stripper No. 3	203
Contact VA 1500	87	PTFE-Spray	147	WEICONTOOLS Crimp-Set Pro	214
Contact VA 180 HT	88	Pump Dispenser	169	WEICONTOOLS Data-Strip No. 30	207
Contact VA 20	85	Pump Dispenser „Special“	169	WEICONTOOLS Dismantling Tool No. 25	212
Contact VA 200 HR	88	Repair Stick Aluminium	39	WEICONTOOLS Duo-Crimp No. 300	206
Contact VA 250 Black	89	Repair Stick Aqua	36	WEICONTOOLS Duo-Stripper No. 200	208
Contact VA 2500 HT	88	Repair Stick Concrete	39	WEICONTOOLS Easy Opener®	213
Contact VA 30 Black	89	Repair Stick Copper	39	WEICONTOOLS Electrical Installation Sets	215
Contact VA 300	87	Repair Stick Multi-Purpose	38	WEICONTOOLS LSA Sensor No. 40	211
Contact VA 8312	85	Repair Stick Plastic	38	WEICONTOOLS Mini Solar No. 3	210
Contact VA 8406	86	Repair Stick Stainless Steel	37	WEICONTOOLS Mini-Duo No. 150	208
Contact VM 120	91	Repair Stick Steel	36	WEICONTOOLS Multi-Opener	213
Contact VM 20	91	Repair Stick Titanium	37	WEICONTOOLS Multi-Stripper No. 400	209
Contact VM 2000	91	Repair Stick Wood	38	WEICONTOOLS No. 7 Solar	210
Contour Spatula Flexy	20	Repair Tapes	41	WEICONTOOLS Precision Wire Strippers S	201
Copper Paste	184	RK-1300	51	WEICONTOOLS Quadro-Stripper No. 16	205
Copper Paste Assembly Spray	150	RK-1500	51	WEICONTOOLS Round Cable Stripper No. 13	204
Copper Spray	128	RK-Activator	51	WEICONTOOLS Round Cable Stripper No. 13 Classic	204
Corro-Protection (Liquid)	163	Rost Shock	140	WEICONTOOLS Starter-Set Pro	214
Corro-Protection (Spray)	129	Rust Converter (Liquid)	163	WEICONTOOLS Stripper No. 100	207
Crack Testing Agent	153	Rust Converter (Spray)	163	WEICONTOOLS Stripper No. 2 Cat	203
Dispenser 2C	109	Rust Loosener	170	WEICONTOOLS Wire Stripper No. 5	198
Easy-Mix HT 180	43	Rust Loosener and Contact Spray	141	WEICONTOOLS Wire Stripper No. 5 Classic	199
Easy-Mix HT 250	43	Rust Loosener Fluid	141	WEICONTOOLS Wire Stripper No. 6	199
Easy-Mix Metal	43	Rust Protection 2000 PLUS	126	WEICONTOOLS Wire Stripper No. 7 Magic	200
Easy-Mix N 50	43	Screen Cleaner	137	WEICONTOOLS Wire Stripper No. 7-F	200
Easy-Mix N 5000	43	Sealant and Adhesive Remover (Liquid)	165	Windscreen Adhesive	102
Easy-Mix PE-PP 45	55	Sealant and Adhesive Remover (Spray)	136	Workshop Cleaner	167
Easy-Mix PE-PP 50	54	Silicone	175	WPS 1500	177
Easy-Mix PU Crystal	48	Silicone A	110	WSD 400	177
Easy-Mix PU-240	48	Silicone F	110	Zinc Spray	124
Easy-Mix PU-90	48	Silicone Grease	189	Zinc Spray bright grade	124
Easy-Mix RK-7000	53	Silicone LP	110	Zinc-Alu-Spray	124
Easy-Mix RK-7100	53	Silicone N	111		
Easy-Mix RK-7100 black	53	Silicone Spray	146		
Easy-Mix RK-7200	53	Silicone-Fluid	146		
Easy-Mix RK-7300	52	Smoke Detector Test Spray	155		
Easy-Mix S 50	43	Smoke Detector Test Spray non-flammable	155		
Easy-Mix S 50 yellow	43	Smoothing Agent	117		
Electro Contact Cleaner (Liquid)	164	Solar-Flex®	105		
Electro Contact Cleaner (Spray)	136	Speed-Flex®	102		
Epoxy Minute Adhesive	42	Speed-Flex® Crystal	102		
Epoxy Minute Adhesive Set	42	Spray-on Grease H1	149		
Epoxy Resin Putty	27	Spray-on Grease white	149		
Ergo Connect for Presspack	98	Stainless Steel Care	168		
Fast Cleaner (Liquid)	165	Stainless Steel Care Spray	138		
Fast Cleaner (Spray)	132	Stainless Steel Care Spray A7	138		
Fast-Bond	108	Stainless Steel Spray	127		
Fast-Metal Minute Adhesive	42	Stainless Steel Spray bright grade	127		
Fast-Metal Minute Adhesive Set	42	Starter-Spray	155		
Fitting Spray	146	Surface Cleaner (Liquid)	164		
Flex 310 M® 2 K	101	Surface Cleaner (Spray)	133		
Flex 310 M® Classic	99	Thread Sealing Cord DF 175	82		
Flex 310 M® Crystal	99	Threadlocking Varnish	83		
Flex 310 M® FireSeal	104	Top-Lube	148		
Flex 310 M® HT 200	101	Top-Lube-Fluid	148		
Flex 310 M® Liquid	100	Universal Spatula white	132		
Flex 310 M® ProSeal	104	Universal Spray-on Grease with MoS ₂	148		
Flex 310 M® Stainless-Steel	100	Urethane Colour Paste	46		
Flex 310 M® Super-Tack	100	Urethanes	47		
Flex 310 PU	108	Visor Cleaner	137		
Flex-bond®	103	W 44 T® (Liquid)	173		



WEICON TOOLS®

No.1 in Form & Funktion

WEICON®

WEICON GmbH & Co. KG
(Headquarters)
Germany
phone +49 (0) 251 9322 0
info@weicon.de

WEICON Middle East L.L.C.
United Arab Emirates
phone +971 4 880 25 05
info@weicon.ae

WEICON Inc.
Canada
phone +1 877 620 8889
info@weicon.ca
www.weicon.ca

WEICON Kimya Sanayi Tic. Ltd. Şti.
Turkey
phone +90 (0) 212 465 33 65
info@weicon.com.tr
www.weicon.com.tr

WEICON Romania SRL
Romania
phone +40 (0) 3 65 730 763
office@weicon.com

WEICON SA (Pty) Ltd
South Africa
phone +27 (0) 21 709 0088
info@weicon.co.za

WEICON South East Asia Pte Ltd
Singapore
phone (+65) 6710 7671
info@weicon.com.sg

WEICON Czech Republic s.r.o.
Czech Republic
phone +42 (0) 417 533 013
info@weicon.cz

WEICON Ibérica S.L.
Spain
phone +34 (0) 914 7997 34
info@weicon.es

WEICON Italia S.r.L.
Italy
phone +39 010 292 4871
info@weicon.it